

Welkom bij O-leading

O-Leading streeft ernaar uw one-stop-oplossingspartner te zijn in de toeleveringsketen van EMS, inclusief PCB-ontwerp, PCB-fabricage en PCB-assemblage (PCBA). We kunnen ondersteuning bieden van snelle prototypes tot middelgrote en massaproductie. ([Controlbordontwerp en fabricage PCB- en PCBA-assemblage](#))

Over het algemeen zijn onze wereldwijde klanten erg onder de indruk van onze diensten: snelle respons, concurrerende prijs en kwaliteitsbewustzijn. Waardevollere technische service en een algehele oplossing is de weg die O voorwaarts leidt.

Kijkend naar de toekomst, zal O-leading zich zoals altijd concentreren op de innovatie en ontwikkeling van elektronica-productietechnologie en aanhoudende inspanningen leveren op het gebied van PCB & PCBA one-stop-service om eersteklas services te bieden en meer waarde voor onze klanten te creëren.

KLIK OP DEZE VOOR MEER INFORMATIE: [E.lectronic OEM 4-laags printplaat-assemblage Sensor Pcba-fabriek](#)

Productomschrijving

HOW O-LEADING MAKE A PROJECT FOR YOU

Hardware Dispenser Application Not

Automatic Dispenser Application Not

Voltage Table

Volt Pin Number	Description
VDD	Battery voltage
+3V3	+3.3V
+5V	+5V
USB +5V	USB 5V input
+5V/2	Isolated +5V
+12V	12V DC Drive

STM32F072 PINOUT table

Wire Name	Description	DIO	Mode	Note
SMTN_TOF	Shutdown Time of flight sensor	Output		Logic '0' to shutdown
I2C_SCL_TOF	I2C communication with time of flight sensor	I2C1_SCL		
I2C_SDA_TOF	I2C communication with thermopile sensor	I2C1_SDA		
I2C_SCL_IR	I2C communication with thermopile sensor	I2C2_SCL		
I2C_SDA_IR	I2C communication with thermopile sensor	I2C2_SDA		
RATE_LC	Load cell control pins	Output		
DOUT_LC	Load cell control pins	Output		

O-LEADING
TO BE RELIABLE, TO BE AVAILABLE

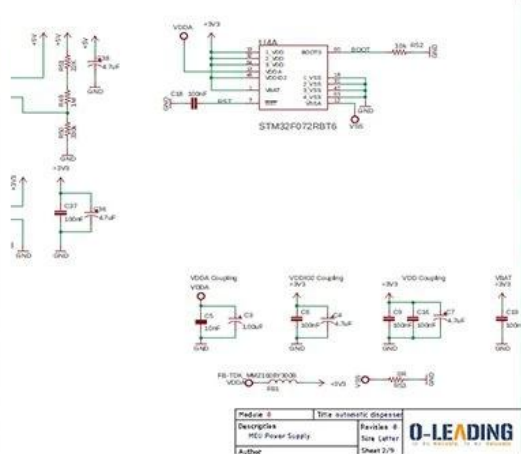

HARDWARE schematics

PCB PRODUCTION COMPONENTS SOURCING

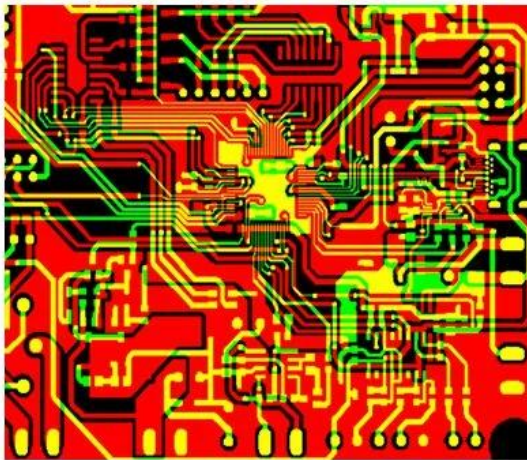

Qty	Value	Device	Parts	Description
4	AK500/2	AK500/2	X1, X2	CONNECTOR
1	AK500/3	AK500/3	X7	CONNECTOR
1	1241148	MA04-2	SV2	
1	PPPC04	MA04-2	SV1	8 POS, 4*2 FEMALE PIN HEAD
1	ML10	ML10	SV4	HARTING
1	8MHZ	XTALL_CSTCE8M	X5	STCE8M00G52-R0 RESONATOR
1	0R	R-0603	R53	Thick Film Resistors - SMD 0603
2	10R	R-0603	R12, R5	Thick Film Resistors - SMD 0603
8	100R	R-0603	R1, R2	Thick Film Resistors - SMD 0603
1	270R	R-0805	R15	Thick Film Resistors - SMD 0605
1	330R	R-0603	R11	Thick Film Resistors - SMD 0603
9	680R	R-0603	R20, R3	Thick Film Resistors - SMD 0603
17	1k	R-0603	R9, R10	Thick Film Resistors - SMD 0603
2	4.7k	R-0603	R17, R6	Thick Film Resistors - SMD 0603
2	5.1k	R-0603	R18, R1	Thick Film Resistors - SMD 0603
9	10k	R-0603	R16, R3	Thick Film Resistors - SMD 0603
9	10k	R-0603	R20, R7	Thick Film Resistors - SMD 0603

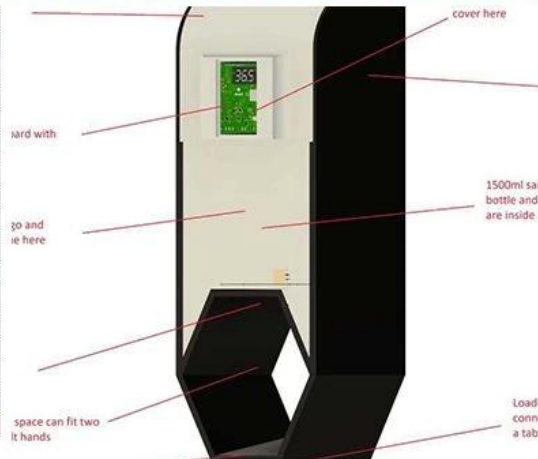
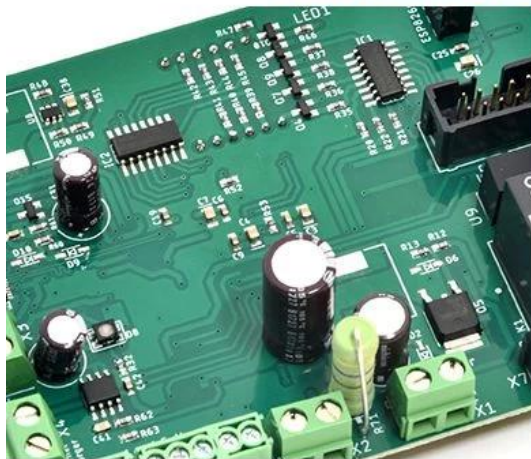

PCB Assembly MECHANICAL DESIGN

TOP QUALITY PCBA

O-LEADING

To Be Reliable, To Be Valuable



MAKE YOUR IDEA COME **TRUE**

TOP QUALITY PCBA

O-LEADING

To Be **Reliable**, To Be **Valuable**

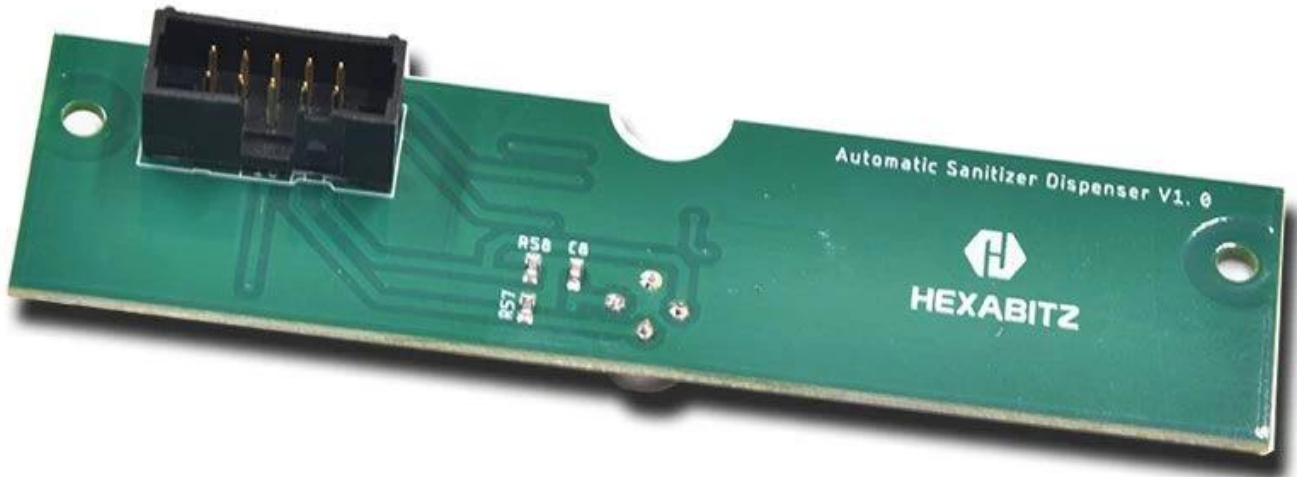

MAKE YOUR IDEA COME **TRUE**

TOP QUALITY PCBA

O-LEADING

To Be Reliable, To Be Valuable

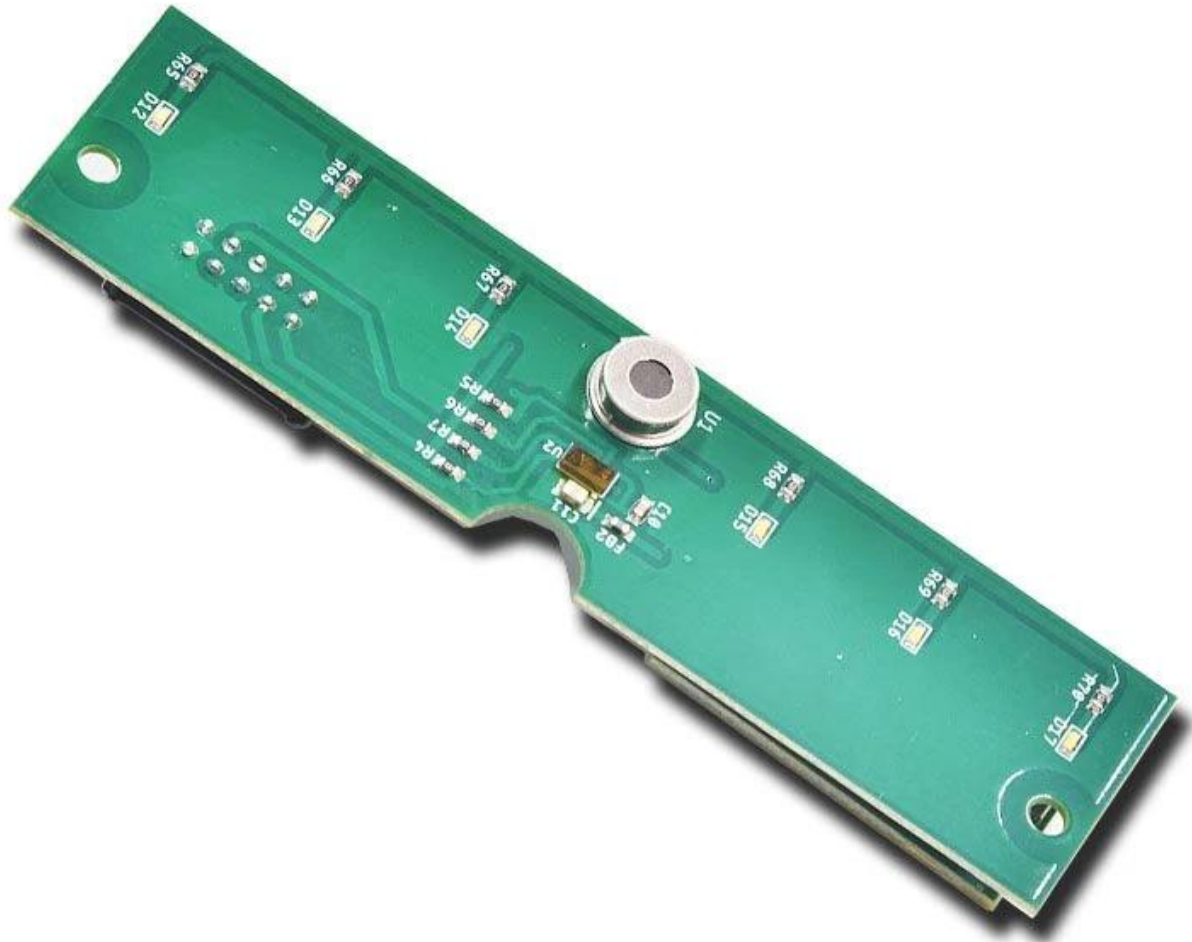

MAKE YOUR IDEA COME TRUE

Process Flow Chart

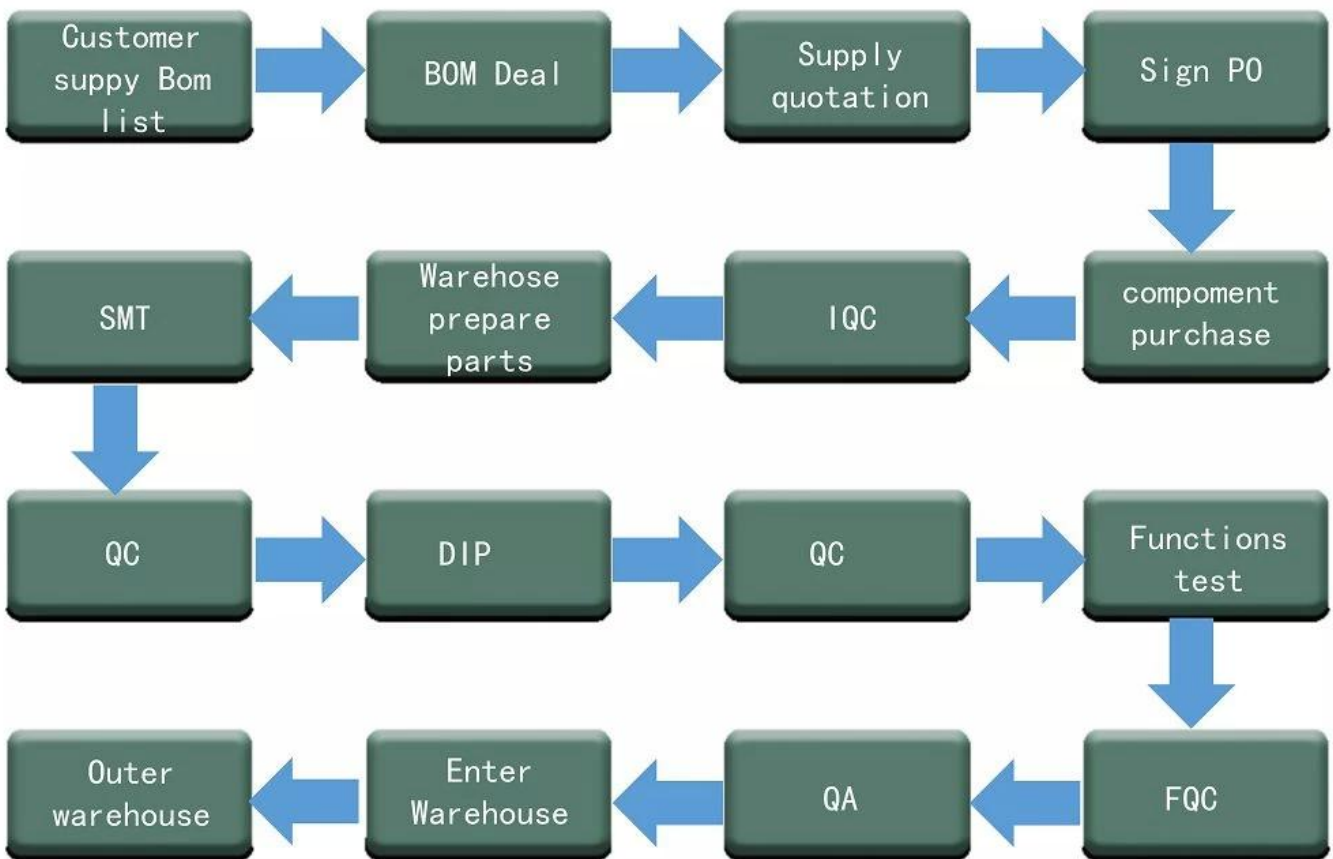

Quality Control Process

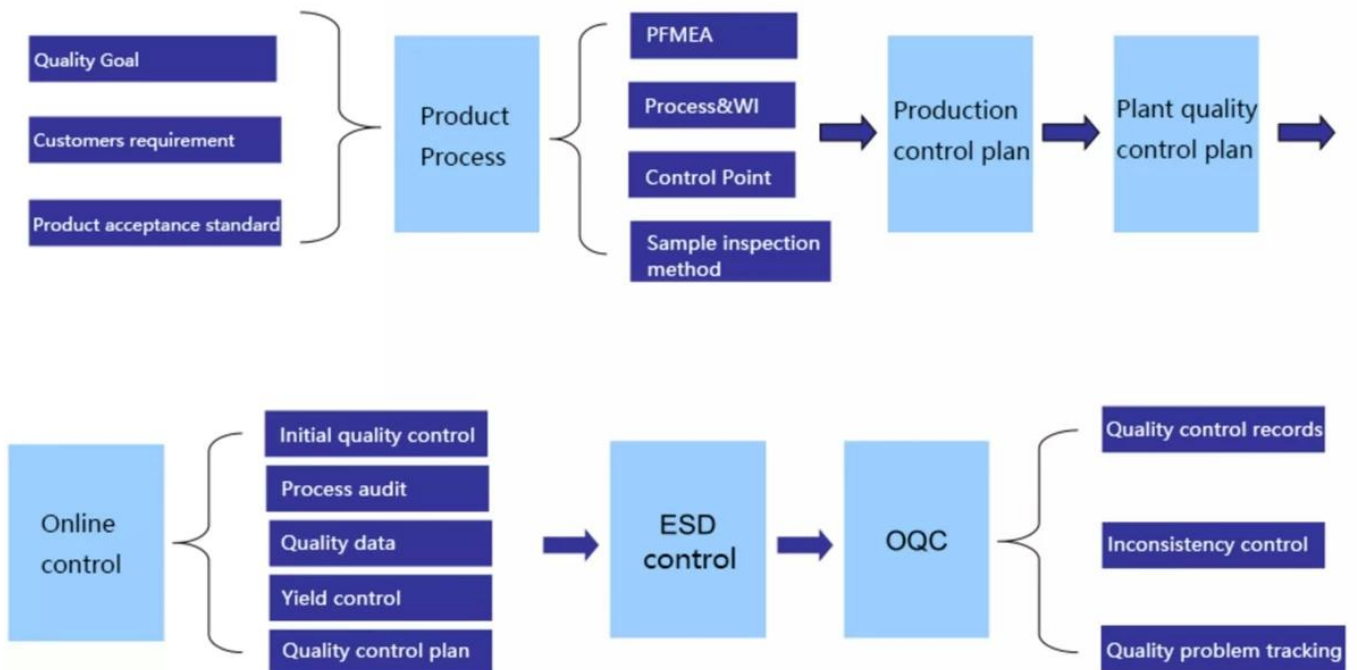



Ons team

O-LEADING *CUSTOMER*

To be *RELIABLE*

- Quality first ,
- Customer supreme ,
- Scientifically management ,
- Striving for famous brand



THE CUSTOMER IS KING



To be *VALUABLE*

- Science and technology keeps head ,
- Put people first ,
- Be precise and practical ,
- contribute sincerely

Factory PCB



Automatic vacuum press machine



Drilling Machine



Pattern Plating Machine



Scrubbing Machine



Developing Machine



Routing Machine



High-speed flying probe machine



E-test Machine

Factory SMT



Skyworth 创维

HET 和而泰
HET INTELLIGENT CONTROL

dongweikeji
东威科技

美的 Midea

STAR-NET
星网锐捷

FORYOU
ADAYO 华阳集团

EDIFIER[®]

Cultraview 金锐显

3nod 三诺

T&W

TCL

AcBel 康舒科技
ACBEL POLYTECH INC.

Honeywell

Schneider
Electric

ZTE 中兴

EMERSON

BYD

PHILIPS

TE
connectivity

VIDEOTON

CUSTOMER VOICE IS **EXTREMELY IMPORTANT** TO US

<p>订单编号: 49335463501024670</p> <p>供应商服务: 非常满意 (5 stars) 按时发货: 非常满意 (5 stars)</p> <p>High quality usb power pcb , pcba manufacturer ★★★★★ Fancy has done an excellent job, whenever we write, she answered us within 1 second, O-leading is very perfect with fast delivery, fast logistics, the most important thing is good quality, good packaging, thank you!</p> <p>回复该评论</p> <p>oem customized rohs pcb drawing schematic s... ★★★★★ We received the boards, the quality is very good, the price is very reasonable, Fancy is very nice & smart & experienced, the logistics is super fast, I will come to see more in the future.</p> <p>回复该评论</p>	<p>订单编号: 49922411001024670</p> <p>供应商服务: 非常满意 (5 stars) 按时发货: 非常满意 (5 stars)</p> <p>High TG180 FR-4 Circuit HDI PCB 94V0 Board... ★★★★★ This is a very difficult PCB design, but we are lucky to find O-leading to support the PCB for us very good to a PCB supplier.</p> <p>universal FR4 Multilayer PCB washing machine... ★★★★★ Fancy gives us very excellent service, very professional and experienced, O-leading is the best one of our suppliers, very happy to work with them.</p>
<p>订单编号: 49298271001024670</p> <p>供应商服务: 非常满意 (5 stars) 按时发货: 非常满意 (5 stars)</p> <p>High TG180 FR-4 Circuit HDI PCB 94V0 Board... ★★★★★ perfect product, perfect PCB supplier!</p> <p>回复该评论</p> <p>oem customized rohs pcb drawing schematic s... ★★★★★ Very good and professional PCB product as usual!</p> <p>回复该评论</p> <p>Strip LED Aluminum FR-4 lighting PCB board 9... ★★★★★ High quality, fast delivery, good service, competitive price, lucky and happy to purchase from O-leading!</p> <p>回复该评论</p>	<p>订单编号: 49024962001024670</p> <p>United States 供应商服务: 非常满意 (5 stars) 按时发货: 非常满意 (5 stars)</p> <p>High quality Keyboard pcb & pcba Factory SMT... ★★★★★ Top quality, it's the right choice to choose O-leading to make the PCB & PCBA</p> <p>回复该评论</p>
	<p>订单编号: 499862201024670</p> <p>供应商服务: 非常满意 (5 stars) 按时发货: 非常满意 (5 stars)</p> <p>Professional Printed Circuit Board Manufactur... ★★★★★ Very high quality PCB products, O-leading is the best PCB supplier that we have ever worked with.</p>
	<p>订单编号: 44068794501034670</p> <p>供应商服务: 非常满意 (5 stars) 按时发货: 非常满意 (5 stars)</p> <p>High TG180 FR-4 Circuit HDI PCB 94V0 Board... ★★★★★ We bought two batches, one by DHL, the other one by air, good quality and fast delivery!</p>

LISTEN TO **CUSTOMER VOICE**

<p>订单编号: 40903347501024670</p> <p>供应商服务: 非常满意 (5 stars) 按时发货: 非常满意 (5 stars)</p> <p>Strip LED Aluminum FR-4 lighting PCB board 9... ★★★★★ Very fast delivery! Fantastic, good job!!!</p> <p>Professional Printed Circuit Board Manufactur... ★★★★★ Very happy to great support from O-leading, they are not only professional on the PCB, but also provide good PCB products, very good supplier!</p>	<p>订单编号: 36919647001024670</p> <p>供应商服务: 非常满意 (5 stars) 按时发货: 非常满意 (5 stars)</p> <p>AML-S802 Quad-core Android embedded boar... ★★★★★ Good products</p> <p>Fast delivery low cost pcb fabrication O-leadin... ★★★★★ Good supplier</p>
<p>hot sale rigid-flexible PCB with 0.2mm BGA an... ★★★★★ very professional supplier</p> <p>High Quality custom FPCB/Flex PCB/FPC/Flexi... ★★★★★ Good product</p> <p>OEM ODM PCBA Bluetooth Wireless Marking G... ★★★★★ high soldering quality</p> <p>Electronic parts haptic pcba Circuit Board asse... ★★★★★ Very Good product</p>	<p>Lidar IR Sensor board pcba(H08R6x) ★★★★★ perfect product</p> <p>Customized PCBA design PCB design ★★★★★ perfect</p> <p>Audio Speaker and Headphone Jack (H07R3x) ★★★★★ High quality, good</p>
<p>订单编号: 37378603001024670</p> <p>供应商服务: 非常满意 (5 stars) 按时发货: 非常满意 (5 stars)</p> <p>Raspberry pi 0 Zero Raspberry Pi Zero PI W ver... ★★★★★ Fantastic products!!!</p> <p>double layer pcb with red S/M and LF-HASL su... ★★★★★ Good!</p>	<p>half hole pcb, half hole pcb module, half hole m... ★★★★★ Top half hole pcb supplier, very perfect goods</p> <p>High Quality custom FPCB/Flex PCB/FPC/Flexi... ★★★★★ this rigid-flexible pcb quality is perfect!</p> <p>Electronic parts haptic pcba Circuit Board asse... ★★★★★ Very satisfied with O-leading products and quality, especially their on-time delivery, fantastic!</p>

Be kind to your client, because he has many choices, but he chooses you instead.

Certificaten

O-LEADING *TRAINING*



Keep *LEARNING*

There's a phrase in Buddhism, 'Beginner's mind.'

It's wonderful to have a beginner's mind

WE HAVE A *DREAM*

Keep *RUNNING*

I would like to live to study, and not study to live.

----Bacon

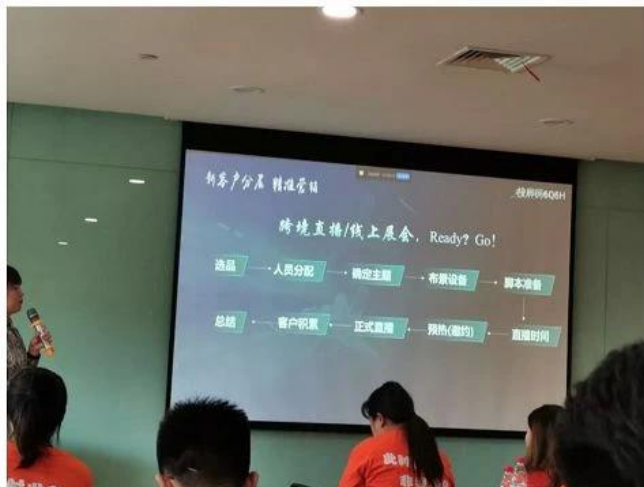



Test Report No. SZXEC1900530401 Date: 30 Mar 2019 Page 1 of 6

O-LEADING SUPPLY CHAIN (HK) CO., LIMITED
1313.FLOOR 13, FORTUNE BUILDING, DANSHUI TOWN, HUIYANG DISTRICT, HUIZHOU, GUANGDONG, CHINA

The following sample(s) was/were submitted and identified on behalf of the clients as : OSP

SGS Job No. : RP19-005089 - SZ
Date of Sample Received : 22 Mar 2019
Testing Period : 22 Mar 2019 - 30 Mar 2019
Test Requested : Selected tests(s) as requested by client.
Test Method : Please refer to next page(s).
Test Results : Please refer to next page(s).

Conclusion : Based on the performed tests on submitted sample(s), the results of Lead, Mercury, Cadmium, Hexavalent chromium, Polybrominated biphenyls (PBBs), Polybrominated diphenyl ethers (PBDEs) and Phthalates such as Bis(2-ethylhexyl) phthalate (DEHP), Butyl benzyl phthalate (BBP), Dibutyl phthalate (DBP), and Diisobutyl phthalate (DIBP) comply with the limits as set by RoHS Directive (EU) 2015/863 amending Annex II to Directive 2011/65/EU.

Signed for and on behalf of
SGS-CSTC Standards Technical Services Co., Ltd. Shenzhen Branch

Tina
Tina Fan
Approved Signatory



Unless otherwise agreed in writing, this document is issued by the Company subject to its General Conditions of Service printed on the reverse side of this document or available at www.sgs.com. The Client's attention is drawn to the limitation of liability, indemnification and jurisdiction issues defined therein. Any holder of this document is advised that information contained herein reflects the Company's findings at the time of its intervention only and within the limits of the Client's instructions. In any event, the Company's sole responsibility is to its Client and the document does not exonerate parties to a transaction from respecting all their rights and obligations under the transaction documents. This document cannot be reproduced or used in any manner whatsoever without the prior written approval of the Company. Any unauthorized alteration, forgery or falsification of the content or appearance of this document is unlawful and offenders may be prosecuted to the fullest extent of the law. Unless otherwise stated the liability shown in this report refers only to the specific tested item.

Attention: To check the authenticity of testing SGS-CSTC Reports & certificates, please contact us at telephone: (86-755) 8307 1443 or website: CN.sgs.com

SGS 检测有限公司 深圳分公司 地址: 深圳市福田区福安路11号 邮编: 518129 电话: (86-755) 25288888 / (86-755) 83071000 传真: (86-755) 25288888 / (86-755) 83071000 电子邮箱: china@sgs.com

Member of the SGS Group (SGS SA)



Test Report No. SZXEC1900530401 Date: 30 Mar 2019 Page 2 of 6

Test Results :

Test Part Description :

Specimen No.	SGS Sample ID	Description
SN1	SZX19-005304.001	Green"PCB"

- Remarks :
- (1) 1 mg/kg = 1 ppm = 0.0001%
 - (2) MDL = Method Detection Limit
 - (3) ND = Not Detected (< MDL)
 - (4) "-" = Not Regulated

RoHS Directive (EU) 2015/863 amending Annex II to Directive 2011/65/EU

Test Method : With reference to IEC 62321-4:2013+A1:2017, IEC62321-5:2013, IEC62321-7-2:2017, IEC 62321-6:2015 and IEC62321-8:2017, analyzed by ICP-OES, UV-Vis and GC-MS.

Test Item(s)	Limit	Unit	MDL	0/1
Cadmium (Cd)	100	mg/kg	2	ND
Lead (Pb)	1,000	mg/kg	2	8
Mercury (Hg)	1,000	mg/kg	2	ND
Hexavalent Chromium (Cr(VI))	1,000	mg/kg	8	ND
Sum of PBBs	1,000	mg/kg	-	ND
Monobromobiphenyl	-	mg/kg	5	ND
Dibromobiphenyl	-	mg/kg	5	ND
Tribromobiphenyl	-	mg/kg	5	ND
Tetrabromobiphenyl	-	mg/kg	5	ND
Pentabromobiphenyl	-	mg/kg	5	ND
Hexabromobiphenyl	-	mg/kg	5	ND
Heptabromobiphenyl	-	mg/kg	5	ND
Octabromobiphenyl	-	mg/kg	5	ND
Nonabromobiphenyl	-	mg/kg	5	ND
Decabromobiphenyl	-	mg/kg	5	ND
Sum of PBDEs	1,000	mg/kg	-	ND
Monobromodiphenyl ether	-	mg/kg	5	ND
Dibromodiphenyl ether	-	mg/kg	5	ND
Tribromodiphenyl ether	-	mg/kg	5	ND
Tetrabromodiphenyl ether	-	mg/kg	5	ND
Pentabromodiphenyl ether	-	mg/kg	5	ND



Unless otherwise agreed in writing, this document is issued by the Company subject to its General Conditions of Service printed on the reverse side of this document or available at www.sgs.com. The Client's attention is drawn to the limitation of liability, indemnification and jurisdiction issues defined therein. Any holder of this document is advised that information contained herein reflects the Company's findings at the time of its intervention only and within the limits of the Client's instructions. In any event, the Company's sole responsibility is to its Client and this document does not exonerate parties to a transaction from respecting all their rights and obligations under the transaction documents. This document cannot be reproduced or used in any manner whatsoever without the prior written approval of the Company. Any unauthorized alteration, forgery or falsification of the content or appearance of this document is unlawful and offenders may be prosecuted to the fullest extent of the law. Unless otherwise stated the liability shown in this report refers only to the specific tested item.

Attention: To check the authenticity of testing SGS-CSTC Reports & certificates, please contact us at telephone: (86-755) 8307 1443 or website: CN.sgs.com

SGS 检测有限公司 深圳分公司 地址: 深圳市福田区福安路11号 邮编: 518129 电话: (86-755) 25288888 / (86-755) 83071000 传真: (86-755) 25288888 / (86-755) 83071000 电子邮箱: china@sgs.com

Member of the SGS Group (SGS SA)



ZPMV2.E490354 - WIRING, PRINTED - COMPONENT

Wiring, Printed - Component

See General Information for Wiring, Printed - Component

O-LEADING SUPPLY CHAIN (HK) CO LTD

E490354

ROOM 1205, 12/F
TAI SANG BANK BLDG
130-132 DES VOEUS ROAD
CENTRAL, HONG KONG

Type	Cond Width			SS/ DS/ DSO	Max	Max			Meets UL796	C T	
	Min	Cond	Area		Solder	Flame	Class				
	Min	Edge			Thk			Oper			
mm(in)	mm(in)	mic(mil)	Diam	Limits	Temp	DSR	I				
Multilayer (mass laminate) printed wiring boards.											
O-LEADING-401	0.1 (0.004)	0.3 (0.012)	34 (1.34)	DS	12.7 (0.5)	260	10	130	V-0	-	-
O-LEADING-407	0.08 (0.003)	0.2 (0.008)	17 (0.67)	DS	9.7 (0.4)	260	10	130	V-0	All	-
Multilayer printed wiring boards.											
O-LEADING-408	0.125 (0.005)	0.125 (0.005)	12 (0.47) Int:136	DS	50.8 (2.0)	280	20	130	V-0	All	*
Single layer printed wiring boards.											
O-LEADING-002	0.38 (0.015)	1.14 (0.045)	34 (1.34)	SS	19.1 (0.8)	260	10	105	V-0	All	-
O-LEADING-003	0.38 (0.015)	1.14 (0.045)	34 (1.34)	SS	19.1 (0.8)	260	10	130	V-0	▲	-
O-LEADING-033	0.15 (0.006)	0.3 (0.012)	34 (1.34)	SS	25.4 (1.0)	260	10	120	V-0	All	-
O-LEADING-205	0.1 (0.004)	0.3 (0.012)	34 (1.34)	DS	69.6 (2.7)	260	10	130	V-0	All	-
O-LEADING-206	0.15 (0.006)	0.33 (0.013)	17 (0.67)	DS	69.6 (2.7)	260	10	130	V-0	All	-
O-LEADING-D01	0.14 (0.006)	0.15 (0.006)	33 (1.30)	DS	25.4 (1.0)	260	10	130	V-0	All	*
O-LEADING-S01	0.25 (0.010)	0.25 (0.010)	17 (0.67)	SS	25.4 (1.0)	260	4	130	V-0	All	*

WIRING, PRINTED - COMPONENT | UL Product iQ

O-LEADING-S02	0.2 (0.008)	0.2 (0.008)	17 (0.67)	SS	25.4 (1.0)	260	4	130	HB	▲	*
O-LEADING-S03	0.25 (0.010)	0.25 (0.010)	34 (1.34)	SS	25.4 (1.0)	260	4	130	V-0	All	*

* - CTI marking is optional and may be marked on the printed wiring board.

Marking: Company name or file number and type designation. May be followed by a suffix to denote factory identification or burning test classification.

并不是所有出现在本数据库中的公司名称和产品都满足了UL跟踪检验服务的要求。只有带有UL标志的产品，才应该被视为经过UL认证，并满足UL跟踪检验服务的要求。注意查看产品上的标志。

UL 允许在线认证目录中所含材料的复制遵循以下条件：1.指南信息、装配、构造、设计、系统和/或认证（文件）必须在不篡改任何数据（或图纸）的情况下完整且无误导性地呈现。2.经UL允许从在线认证目录转载“声明必须出现在所摘录材料的邻近位置。此外，转载材料必须包含以下格式的版权声明：“© 2019 UL LLC”

Procesmogelijkheden

PCB-productiemogelijkheden

Aantal lagen	1Layer-32Layer
Afgewerkt koperdikte	1 / 3oz-12oz
Min Lijnbreedte / interne afstand	3.0mil / 3.0mil
Min Lijnbreedte / externe afstand	4,0 ml / 4,0 ml
Max. Beeldverhouding	10: 1
Board dikte	0,2 mm - 5,0 mm
Max Paneelgrootte (inch)	635 * 1500 mm
Minimale boorgatgrootte	4mil
Gepatenteerde gatentolerantie	+/- 3mil
Blind / Buried Vias (All-typen)	JA
Via vulling (geleidend, niet-geleidend)	JA
Basis materiaal	FR-4, FR-4 hoge Tg, Halogeenvrij materiaal, Rogers, aluminium basis, Polyimide, zwaar koper
Oppervlakteafwerkingen	HASL, OSP, ENIG, HAL-LF, Immersion zilver, Immersion Tin, gouden vingers, Carbon inkt

SMT-productiemogelijkheden

PCB-materiaal	FR-4, CEM-1, CEM-3, plaat op aluminiumbasis
Max PCB-afmeting	510x460mm
Min PCB-afmeting	50x50mm
PCB-dikte	0,5 mm - 4,5 mm
Board dikte	0,5-4 mm
Min componenten grootte	0201
Standaard chipformaat component	0603 en groter
Max. Hoogte onderdeel	15 mm
Min. Voorsprong	0,3 mm
Min BGA-balhoogte	0,4 mm
Plaatsingsprecisie	+/- 0,03 mm

Verpakking en levering

Shipping service



Quick Turn Lead Time		
Layer Count:	Lead Tim	Special Requirement
1L/2L	2-3days	24 Hours,48 Hours
4L	3-4days	48 Hours
6L	4-5days	72 Hours
8L	5-6days	NA
10L	6-7days	NA
12L	7-8days	NA
14L	8-9days	NA

Standard Lead Time		
Layer Count:	Sample Lead Time	Volume order lead time
2L	4 days	10 days
4L	5 days	11 days
6L	6 days	12 days
8L	8 days	14 days
10L	10 days	16 days
12L	12 days	18 days
14L	14 days	20 days
16-32L	18 days	24 days

FAQ

1. Hoe garandeert O-Leading kwaliteit?

Onze hoge kwaliteitsstandaard wordt bereikt met het volgende.

- 1.1 Het proces wordt strikt gecontroleerd volgens de ISO 9001: 2008-normen.
- 1.2 Veel gebruik van software bij het beheer van het productieproces
- 1.3 State-of-art testapparatuur en gereedschappen. Bijv. Flying Probe, X-ray Inspection, AOI (Automated Optical Inspector) en ICT (in-circuit testing).
- 1.4 Specifiek kwaliteitsborgingsteam met analyseproces voor foutgevallen
- 1.5. Permanente opleiding en scholing van personeel

2. Hoe houdt O-Leading uw prijs concurrerend?

In de afgelopen tien jaar zijn de prijzen van veel grondstoffen (bijv. Koper, chemicaliën) verdubbeld, verdrievoudigd of verviervoudigd; De Chinese munteenheid RMB was 31% gestegen ten opzichte van de Amerikaanse dollar; En onze arbeidskosten zijn ook aanzienlijk gestegen.

O-Leading heeft onze prijzen echter stabiel gehouden. Dit is volledig te danken aan onze innovaties in het verlagen van kosten, het vermijden van verspilling en het verbeteren van de efficiëntie. Onze prijzen zijn zeer concurrerend in de branche op hetzelfde kwaliteitsniveau.

Wij geloven in een win-win-samenwerking met onze klanten. Ons partnerschap zal voor beide partijen voordelig zijn als we u een voorsprong kunnen bieden op kosten en kwaliteit.

3. Welke soorten borden kan O-Leading verwerken?

Veel voorkomende FR4-, high-TG- en halogeenvrije borden, Rogers, Arlon, Telfon, aluminium / kopergebaseerde borden, PI, enz.

4. Welke gegevens zijn nodig voor de productie van PCB's en PCBA's?

4.1 BOM (Bill of Materials) met referentie-aanduidingen: componentbeschrijving, naam van de fabrikant en onderdeelnummer.

4.2 PCB Gerber-bestanden.

4.3 PCB-fabricagetekening en PCBA-assemblagetekening.

4.4 Testprocedures.

4.5 Eventuele mechanische beperkingen, zoals vereisten voor montagehoogte.

5. Wat is de typische processtroom voor meerlagige PCB's?

Materiaal snijden → Binnenste droge film → binnenste ets → Binnenste AOI → Multi-binding → Laagstapeling Persen → Boren → PTH → Paneelbepaling → Buitenste droge film → Patroonbepaling → Buitenste etsing → Buitenste AOI → Soldeermasker → Componentmarkering → Oppervlakteafwerking → Routing → E / T → Visuele inspectie.

6. Wat is de belangrijkste uitrusting voor HDI-productie?

De belangrijkste apparatuurlijst is als volgt: laserboormachine, persmachine, VCP-lijn, automatische belichtingsmachine, LDI en etc.

De apparatuur die we hebben is de beste in de branche, laserboormachines zijn van Mitsubishi en Hitachi, LDI-machines zijn van Screen (Japan), automatische belichtingsmachines zijn ook van Hitachi, ze zorgen ervoor dat we kunnen voldoen aan de technische vereisten van de klant.

7. Hoeveel soorten oppervlakteafwerking kan O-lead doen?

O-the leader heeft de volledige reeks oppervlakteafwerkingen, zoals: ENIG, OSP, LF-HASL, gold plating (zacht / hard), immersion silver, tin, silver plating, immersion tin plating, carbon inkt en etc. .. OSP, ENIG, OSP + ENIG dat gewoonlijk wordt gebruikt op de HDI, raden we u meestal aan om een client of OSP OSP + ENIG te gebruiken als de BGA PAD-grootte kleiner is dan 0,3 mm.

8. Wat is uw vermogen voor FPC? Kan O-Leading ook SMT-service verlenen?

O-Leading kan FPC fabriceren van enkele laag tot 8 lagen, het werkpaneel kan zo groot zijn als 2000 mm * 240 mm, de details vindt u op de pagina "Flex-capaciteit"

We bieden ook SMT one-stop-service aan de klant.

9. Wat zijn de belangrijkste factoren die de prijs van PCB's beïnvloeden?

Materiaal;

Oppervlakteafwerking;

Technologie moeilijkheid;

Verschillende kwaliteitscriteria;

PCB-kenmerken;

Betaalvoorwaarden;

Verschillende productielanden.

10. Wat is de definitie van PCB, PWB en FPC en wat is het verschil?

PCB is een afkorting voor Printed Circuit Board;

PWB is een afkorting voor Printed Wire Board, dezelfde betekenis als Printed Circuit Board;

FPC staat voor Flexible Printed Board.

11. Met welke factoren moet rekening worden gehouden bij het kiezen van het materiaal voor een printplaat?

De onderstaande factoren moeten in overweging worden genomen bij het kiezen van het materiaal voor

PCB:

De Tg-waarde van het materiaal moet hoger zijn dan de bedrijfstemperatuur;

Laag CTE-materiaal heeft goede prestaties van thermische stabiliteit;

Goede prestaties op het gebied van thermische weerstand: Normaal gesproken moeten PCB's gedurende ten minste 50 seconden bestand zijn tegen 250 s.

Goede vlakheid; Met het oog op de elektrische eigenschappen wordt materiaal met laag verlies / hoge

permittiviteit gebruikt op hoogfrequente PCB's; Polyimide glasvezelsubstraat gebruikt voor flexibele PCB;

Metalen kern wordt gebruikt wanneer het product strikte eisen stelt aan warmteafvoer.

12. Wat zijn de voordelen van de stevige flexibele printplaat van O-leading?

De rigid-flex PCB van O-leading heeft de karakters van zowel FPC als PCB, dus het kan in sommige speciale producten worden gebruikt. Een deel is flexibel en het andere stijf, het kan helpen om de binnenruimte van het product te besparen, het productvolume te verminderen en de prestaties te verbeteren.

13. Hoe maakt u de impedantieberekening?

Het impedantiecontrolesysteem wordt gedaan met behulp van enkele testcoupons, de SI6000-soft en de CITS 500s-apparatuur van POLAR INSTRUMENTS.

De apparatuur meet de impedantie op een representatieve trackconfiguratiecoupon waarvan de klant ons een bepaalde waarde en tolerantie heeft gegeven.