

Welkom bij O-leading

O-Leading streeft ernaar uw one-stop-oplossingspartner te zijn in de toeleveringsketen van EMS, inclusief PCB-ontwerp, PCB-fabricage en PCB-assemblage (PCBA). We kunnen ondersteuning bieden van snelle prototypes tot middelgrote en massaproductie. ([F.ast Levering Dubbelzijdige printplaatfabrikant](#))

Over het algemeen zijn onze wereldwijde klanten erg onder de indruk van onze diensten: snelle respons, concurrerende prijs en kwaliteitsbewustzijn. Waardevollere technische service en een algehele oplossing is de weg die O voorwaarts leidt.

Kijkend naar de toekomst, zal O-leading zich zoals altijd concentreren op de innovatie en ontwikkeling van elektronica productietechnologie en aanhoudende inspanningen leveren op het gebied van PCB & PCBA one-stop-service om eersteklas services te bieden en meer waarde voor onze klanten te creëren.

KLIC OP DEZE VOOR MEER INFORMATIE: [Dubbelzijdige Pcb Hard Gold Plating Circuit Board Factory](#)

WE ALWAYS PROVIDE YOU
BEST RIGID-FLEXIBLE CIRCUIT

O-LEADING
To Be Reliable, To Be Valuable

WE ALWAYS PROVIDE YOU

BEST HIGH DENSITY INTERCONNECT PCB



Keep *LEARNING*

There's a phrase in Buddhism, 'Beginner's mind.'

It's wonderful to have a beginner's mind

WE HAVE A *DREAM*

Keep *RUNNING*

I would like to live to study and not study to live.

---Bacon

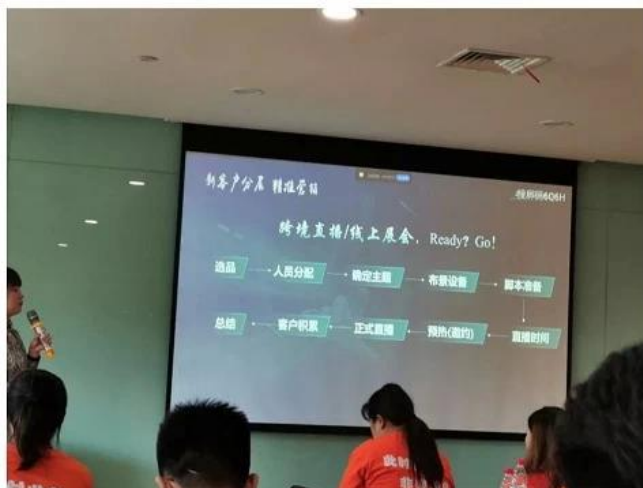

Productomschrijving

Guangdong printplaat leverancier printplaat fabrikant professionele oem pcb printplaat, printplaat fabrikant dubbelzijdige pcb hard goud fabrieksprijs 0,2 6 mm dikte elektronische hardware plating printplaat

TOP QUALITY PCBA

O-LEADING

To Be Reliable, To Be Valuable

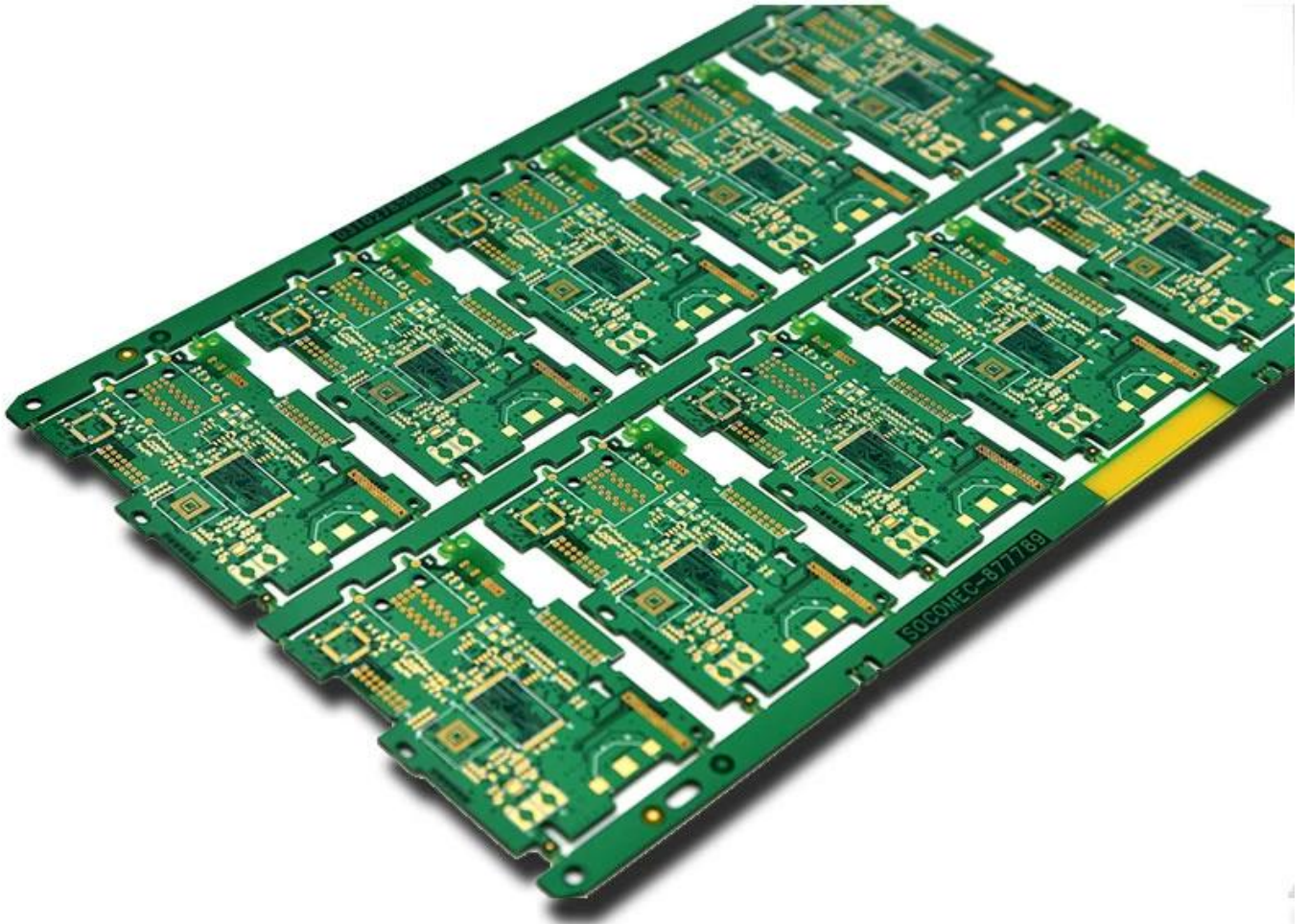

MAKE YOUR IDEA COME **TRUE**

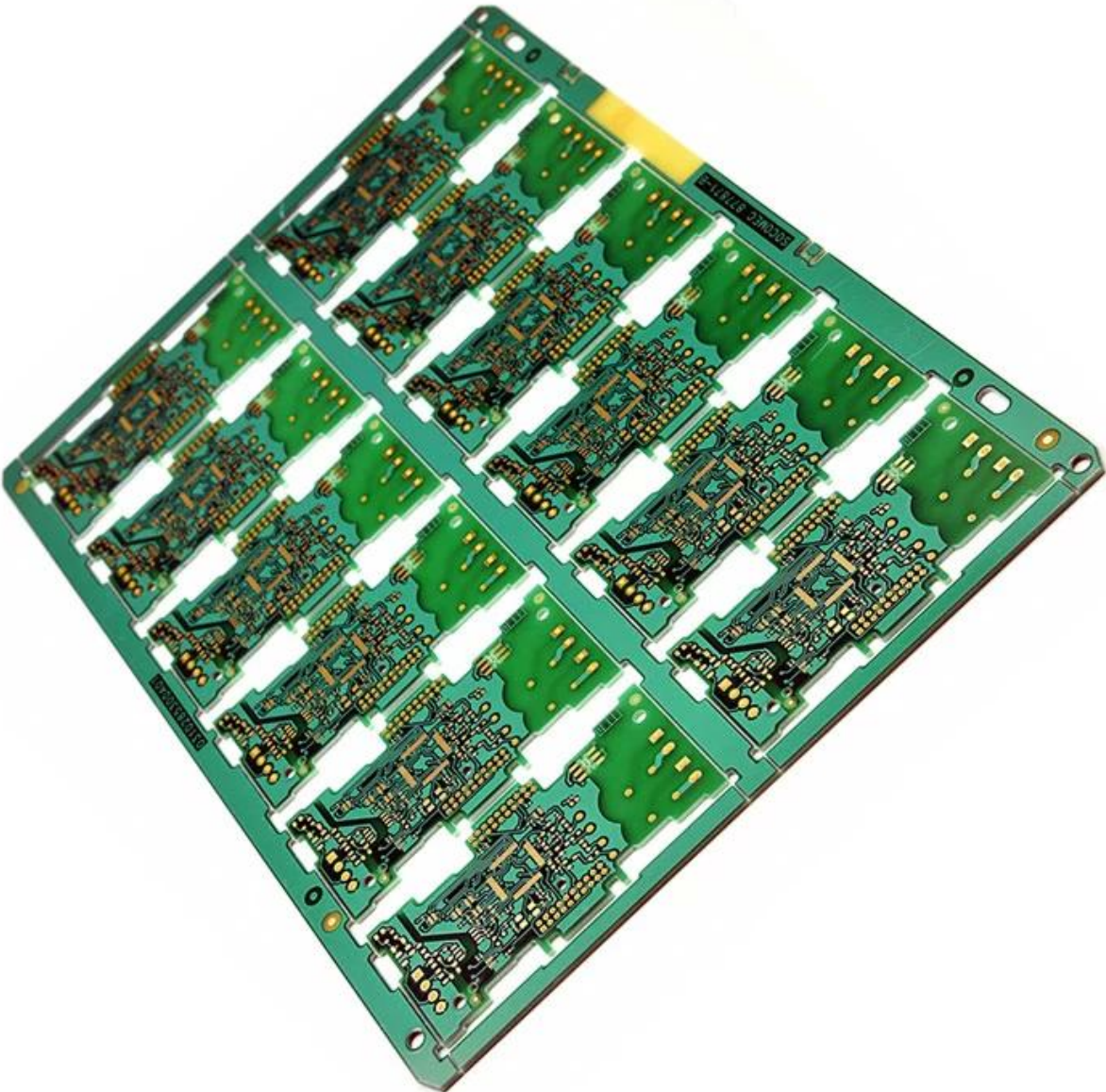

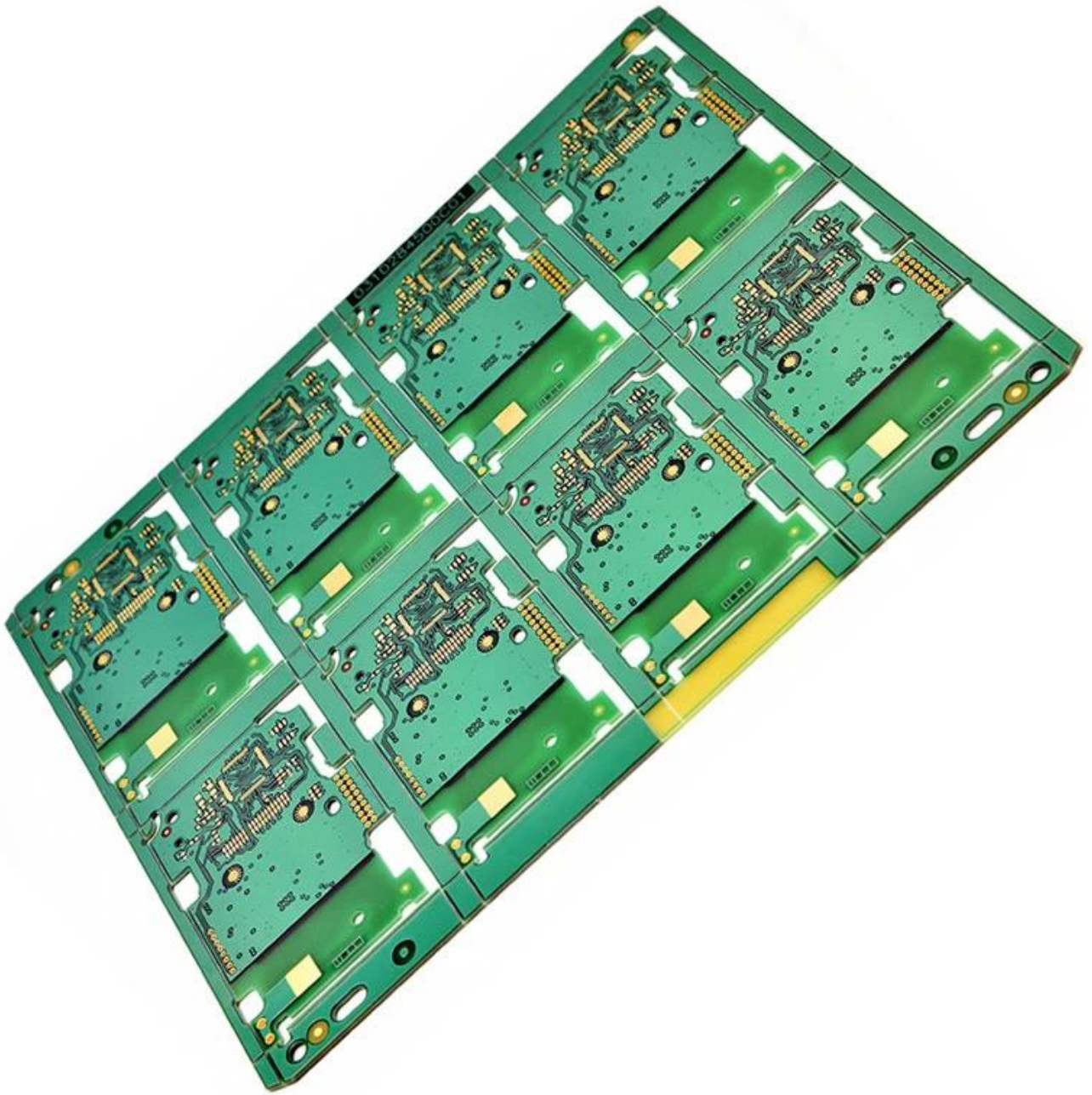

TOP QUALITY PCBA

O-LEADING

To Be Reliable, To Be Valuable



MAKE YOUR IDEA COME TRUE

TOP QUALITY PCBA

O-LEADING

To Be Reliable, To Be Valuable

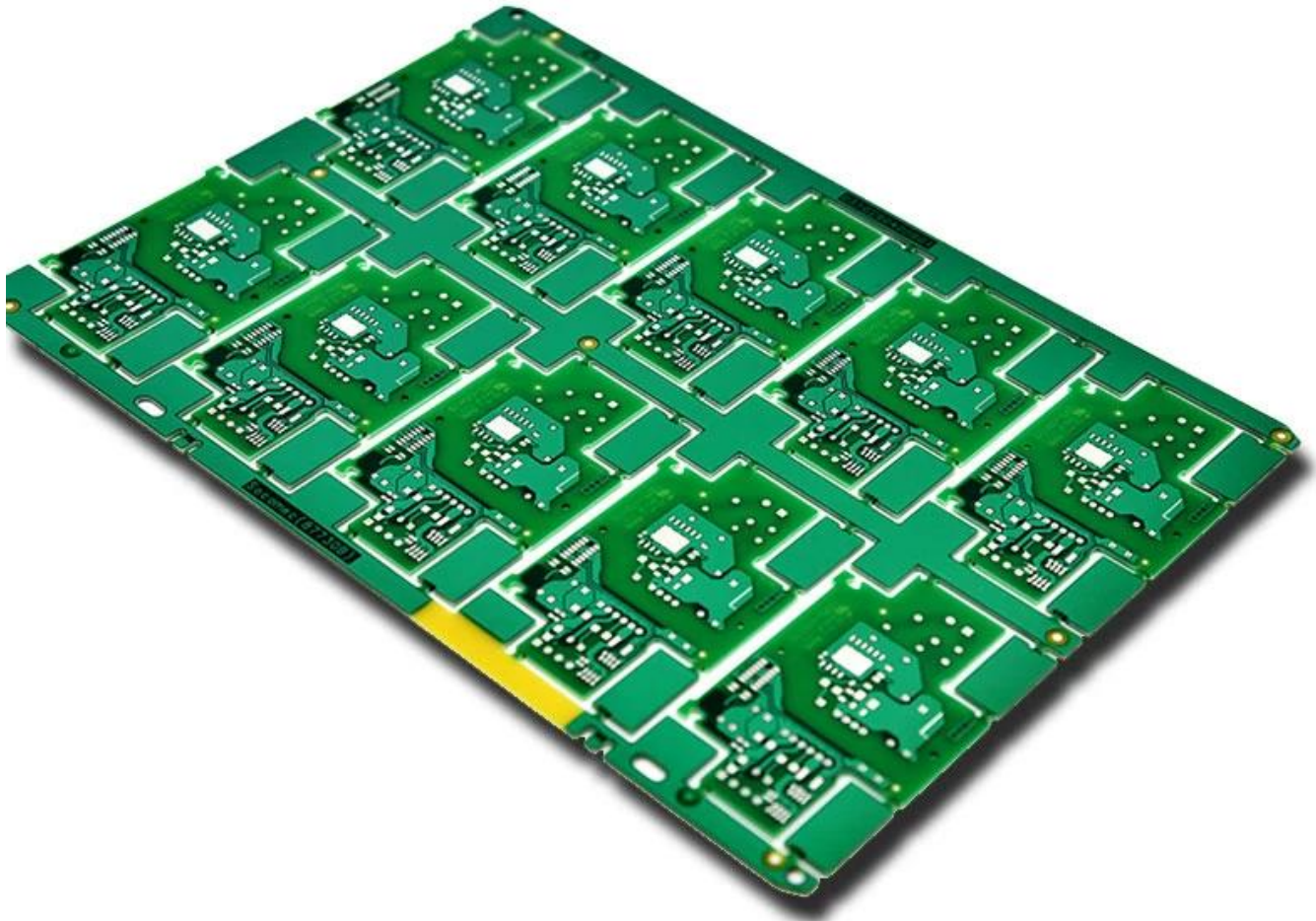

MAKE YOUR IDEA COME TRUE

TOP QUALITY PCBA

O-LEADING

To Be **Reliable**, To Be **Valuable**

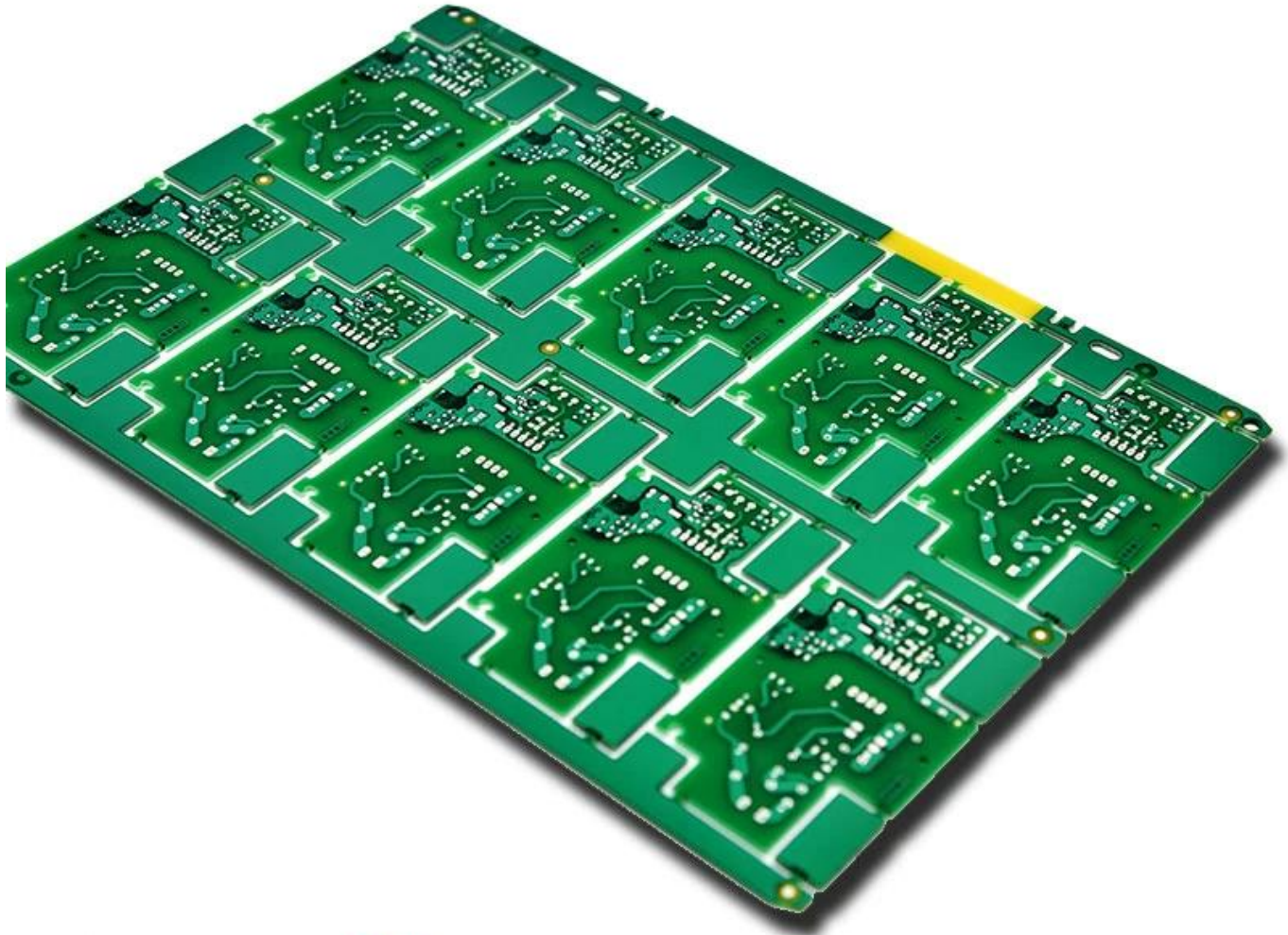

MAKE YOUR IDEA COME **TRUE**

Market Share

 CONSUMER ELECTRONICS

 AUTOMOTIVE ELECTRONICS

 INDUSTRIAL CONTROL

 INTELLECTUALIZED HOUSEHOLD CONTROL

 OTHER



30%
CONSUMER ELECTRONICS

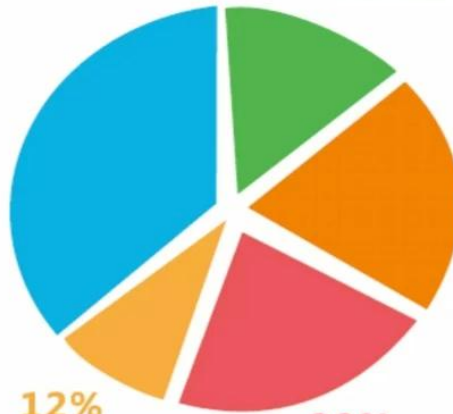

18%
INTELLECTUALIZED HOUSEHOLD CONTROL

20%
AUTOMOTIVE ELECTRONICS



12%
OTHER

20%
INDUSTRIAL CONTROL



Product types

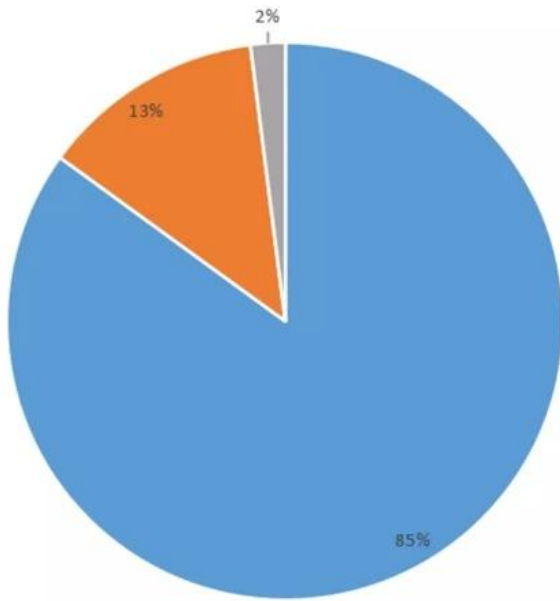

■ FR-4 PCB ■ MC PCB ■ rigid-flexible PCB

Product layers

■ 1L ■ 2L ■ 4L ■ 6L ■ >8L

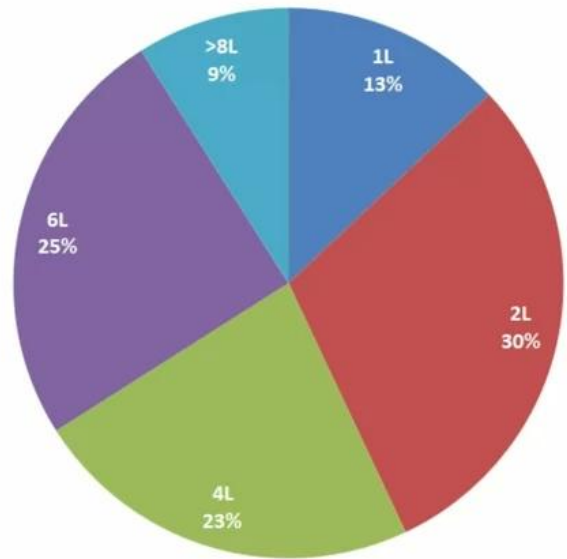

Production Process

18 years experience in one-stop PCB and PCBA, we can make your idea come true,



Ons team



Factory PCB



Automatic vacuum press machine



Drilling Machine



Pattern Plating Machine



Scrubbing Machine



Developing Machine



Routing Machine



High-speed flying probe machine



E-test Machine

Factory SMT



HOW O-LEADING MAKE A PROJECT FOR YOU

Hardware Dispenser Application Not



Automatic Dispenser Application Not

Voltage Table

Volt Pin Number	Description
VDD	Battery Voltage
+3V3	+3.3V
+5V	+5V
USB +5V	USB 5V input
+5V/2	Isolated +5V
+12V	12V DC Drive

STM32F072 PinOUT table

Wire Name	Description	DIO	Mode	Note
SM7N_TOF	Shutdown Time of flight sensor	Output	Logic '1' to shutdown	
I2C_SCL_TOF	I2C communication with time of flight sensor	I2C1_SCL		
I2C_SDA_TOF	I2C communication with thermopile sensor	I2C1_SDA		
I2C_SCL_IR	I2C communication with load cell control pins	I2C2_SCL		
I2C_SDA_IR		I2C2_SDA		
RATE_IC		Output		
DOUT_IC		Output		

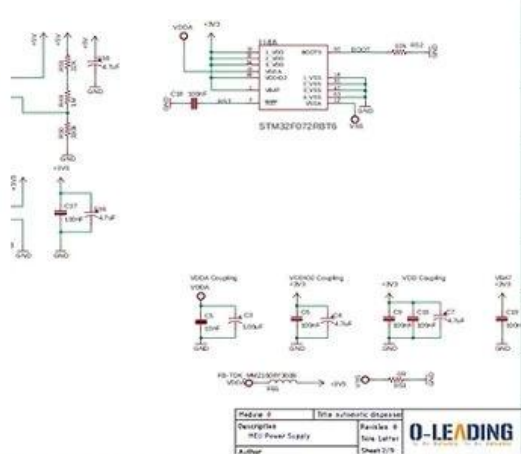

HARDWARE schematics

PCB PRODUCTION COMPONENTS SOURCING

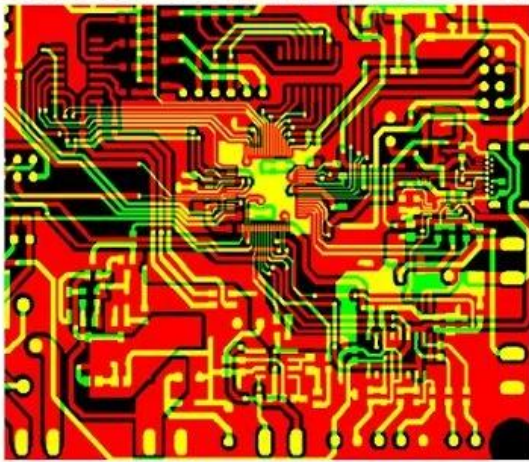

Qty	Value	Device	Parts	Description
4	AK500/1	AK500/2	X1, X2	CONNECTOR
1	AK500/1	AK500/3	X7	CONNECTOR
1	124114	MA04-2	SV2	
1	PPPC04	MA04-2	SV1	8 POS, 4*2 FEMALE PIN HEADE
1	ML10	ML10	SV4	HARTING
1	8MHZ	XTALL_CSTCE8M	X5	STCE8M00G52-R0 RESONATOR
1	0R	R-0603	R53	Thick Film Resistors - SMD 0603
2	10R	R-0603	R12, R5	Thick Film Resistors - SMD 0603
8	100R	R-0603	R1, R2	Thick Film Resistors - SMD 0603
1	270R	R-0805	R15	Thick Film Resistors - SMD 0605
1	330R	R-0603	R11	Thick Film Resistors - SMD 0603
9	680R	R-0603	R20, R3	Thick Film Resistors - SMD 0603
17	1k	R-0603	R9, R10	Thick Film Resistors - SMD 0603
2	4.7k	R-0603	R17, R6	Thick Film Resistors - SMD 0603
2	5.1k	R-0603	R18, R1	Thick Film Resistors - SMD 0603
9	10k	R-0603	R16, R3	Thick Film Resistors - SMD 0603

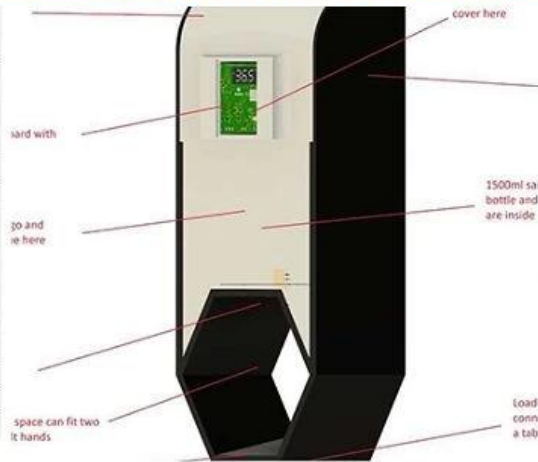
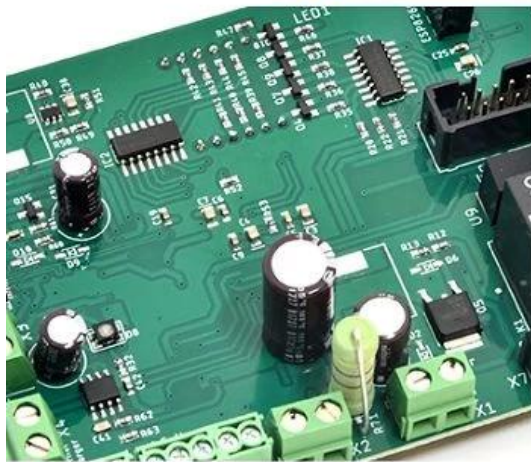

PCB Assembly MECHANICAL DESIGN

O-LEADING CUSTOMER

To be **RELIABLE**

- Q**uality first ,
- C**ustomer supreme ,
- S**cientifically management ,
- S**triving for famous brand



THE CUSTOMER IS KING



To be **VALUABLE**

- S**cience and technology keeps head ,
- P**ut people first ,
- B**e precise and practical ,
- C**ontribute sincerely

Skyworth 创维

HET 和而泰
HET INTELLIGENT CONTROL

dongweikeji
东威科技

美的 Midea

STAR-NET
星网锐捷

FORYOU
ADAYO 华阳集团

EDIFIER[®]

Cultraview 金锐显

3nod 三诺

T&W

TCL

AcBel 康舒科技
ACBEL POLYTECH INC.

Honeywell

Schneider
Electric

ZTE 中兴

EMERSON

BYD

PHILIPS

TE
connectivity

VIDEOTON

O-LEADING **CUSTOMER REVIEW**

CUSTOMER VOICE IS **EXTREMELY IMPORTANT TO US**

订单编号: 49335463501024670

供应商服务: 非常满意 (5 stars) 按时发货: 非常满意 (5 stars)



High quality usb power pcb , pcba manufacturer

★★★★★

Fancy has done an excellent job, whenever we write, she answered us within 1 second, O-leading is very perfect with fast delivery, fast logistics, the most important thing is good quality, good packaging, thank you!

[回复该评论](#)



oem customized rohs pcb drawing schematic s...

★★★★★

We received the boards, the quality is very good, the price is very reasonable, Fancy is very nice & smart & experienced, the logistics is super fast, I will come to see more in the future.

[回复该评论](#)

订单编号: 49298271001024670

供应商服务: 非常满意 (5 stars) 按时发货: 非常满意 (5 stars)



High TG180 FR-4 Circuit HDI PCB 94V0 Board ...

★★★★★

perfect product, perfect PCB supplier!

[回复该评论](#)



oem customized rohs pcb drawing schematic s...

★★★★★

Very good and professional PCB product as usual!

[回复该评论](#)



Strip LED Aluminum FR-4 lighting PCB board 9...

★★★★★

High quality, fast delivery, good service, competitive price, lucky and happy to purchase from O-leading!

[回复该评论](#)

订单编号: 49024962001024670

United States

供应商服务: 非常满意 (5 stars) 按时发货: 非常满意 (5 stars)



High quality Keyboard pcb & pcba Factory SMT...

★★★★★

Top quality, it's the right choice to choose O-leading to make the PCB & PCBA

[回复该评论](#)

订单编号: 4093862201024670

供应商服务: 非常满意 (5 stars) 按时发货: 非常满意 (5 stars)



Professional Printed Circuit Board Manufact...

★★★★★

Very high quality PCB products, O-leading is the best PCB supplier that we have ever worked with.

订单编号: 44068794501024670

供应商服务: 非常满意 (5 stars) 按时发货: 非常满意 (5 stars)



High TG180 FR-4 Circuit HDI PCB 94V0 Board ...

★★★★★

We bought two batches, one by DHL, the other one by air, good quality and fast delivery!

LISTEN TO **CUSTOMER VOICE**

订单编号: 40903347501024670

供应商服务: 非常满意 (5 stars) 按时发货: 非常满意 (5 stars)



Strip LED Aluminum FR-4 lighting PCB board 9...

★★★★★

Very fast delivery! Fantastic, good job!!!



Professional Printed Circuit Board Manufact...

★★★★★

Very happy to great support from O-leading, they are not only professional on the PCB, but also provide good PCB products, very good supplier!



hot sale rigid-flexible PCB with 0.2mm BGA an...

★★★★★

very professional supplier



High Quality custom FPCB/Flex PCB/FPC/Flexi...

★★★★★

Good product



OEM ODM PCBA Bluetooth Wireless Marking G...

★★★★★

high soldering quality



Electronic parts haptic pcba Circuit Board asse...

★★★★★

Very Good product

订单编号: 37378603001024670

供应商服务: 非常满意 (5 stars) 按时发货: 非常满意 (5 stars)



Raspberry pi 0 Zero Raspberry Pi Zero Pi W ver...

★★★★★

Fantastic products!!





double layer pcb with red S/M and LF-HASL su...

★★★★★

Good!

订单编号: 36919647001024670

供应商服务: 非常满意 (5 stars) 按时发货: 非常满意 (5 stars)



AML-S802 Quad-core Android embedded boar...

★★★★★

Good products



Fast delivery low cost pcb fabrication O-leadi...

★★★★★

Good supplier



Lidar IR Sensor board pcba(H08R6x)

★★★★★

perfect product



Customized PCBA design PCB design

★★★★★

perfect



Audio Speaker and Headphone Jack (H07R3x)

★★★★★

High quality, good



half hole pcb, half hole pcb module, half hole m...

★★★★★

Top half hole pcb supplier, very perfect goods



High Quality custom FPCB/Flex PCB/FPC/Flexi...

★★★★★

this rigid-flexible pcb quality is perfect!



Electronic parts haptic pcba Circuit Board asse...

★★★★★

Very satisfied with O-leading products and quality, especially their on-time delivery, fantastic!

Be **kind** to your client,
because he has many choices,
but he chooses you instead.

Certificaten

CICC INSPECTION CERTIFICATION



嘉泰认证

QUALITY MANAGEMENT SYSTEM CERTIFICATE

Certificate No: 18118Q10347R05

We hereby certify that

O-LEADING SUPPLY CHAIN(HK) CO.,LIMITED
 Credit No: 61691591-000-07-18-7
 Registration Add: FLAT/RM 1205 12/F TAI SANG BANK BUILDING 130-132 DES
 VOEUS BOAD CENTRAL HK
 Business Add: 1313, Floor 13, Fortune Building, Danshui Town, Huiyang
 District, Huizhou, Guangdong, China

Has implemented and maintains a **Quality Management System**
 Which fulfils the requirements of the following standards
GB/T19001-2016 idt ISO9001:2015

Scope of certification
 Sales of printed circuit boards

Initial issuance period: February 27, 2018
 Renewal date: April 22, 2019
 This certificate is valid during: April 22, 2019 ~ February 26, 2021
 This certificate is invalid without CICC qualified label in the following period

First supervision and audit	Second supervision and audit	Qualified mark
-----------------------------	------------------------------	----------------

The certification implementation scope does not include those production services which shall be obtained by the relevant effective administrative procedures and qualification procedures regulated by the state.
 The effectiveness of this certificate shall be notified by annual surveillance audits of CICC. The certificate shall be valid also only together with the surveillance audit certificate.
 The initial information of this certificate can be searched at the portal of CICC: www.cicc.com.cn
 Or the site of company: www.o-lead.com





CICC INSPECTION CERTIFICATION



嘉泰认证

质量管理体系认证证书

证书号: 18118Q10347R05

兹证明

诚领供应链(香港)有限公司
 统一社会信用代码: 61691591-000-07-18-7
 注册地址: 香港中環德輔道中 130-132 號大生銀行大廈 1205 室
 经营地址: 广东惠州惠阳淡水南亨西路财富大厦 13 楼 1313

建立的质量管理体系符合
GB/T19001-2016 idt ISO9001:2015 质量标准适用条款的要求

认证范围
 印刷线路板的销售

初次发证日期: 2018年02月27日
 换证日期: 2019年04月22日
 证书有效期: 自2019年04月22日至2021年02月26日
 在下列期限内, 未经 CICC 黏贴合格标贴, 本证书无效

第一次监审	第二次监审	贴标处
-------	-------	-----

本证书认证范围不包括未获得有效的国家规定的行政许可、资质许可的产品/服务范围。
 本证书通过CICC定期监督审核保持, 与年度《保持认证通知书》共同方为有效。
 本证书信息可在国家认监委网站: www.cnca.gov.cn及CICC网站www.cicc.com.cn查询。





Test Report

No. SZXEC1900530401 Date: 30 Mar 2019 Page 1 of 6

O-LEADING SUPPLY CHAIN (HK) CO., LIMITED

1313.FLOOR 13, FORTUNE BUILDING, DANSHUI TOWN, HUIYANG DISTRICT, HUIZHOU, GUANGDONG, CHINA

The following sample(s) was/were submitted and identified on behalf of the clients as : OSP

SGS Job No. : RP19-005089 - SZ
Date of Sample Received : 22 Mar 2019
Testing Period : 22 Mar 2019 - 30 Mar 2019
Test Requested : Selected test(s) as requested by client.
Test Method : Please refer to next page(s).
Test Results : Please refer to next page(s).

Conclusion : Based on the performed tests on submitted sample(s), the results of Lead, Mercury, Cadmium, Hexavalent chromium, Polybrominated biphenyls (PBBs), Polybrominated diphenyl ethers (PBDEs) and Phthalates such as Bis(2-ethylhexyl) phthalate (DEHP) , Butyl benzyl phthalate (BBP), Dibutyl phthalate (DBP) , and Diisobutyl phthalate (DIBP) comply with the limits as set by RoHS Directive (EU) 2015/863 amending Annex II to Directive 2011/65/EU.

Signed for and on behalf of
SGS-CSTC Standards Technical Services Co., Ltd. Shenzhen Branch

Tina
Tina Fan
Approved Signatory



Unless otherwise agreed in writing, this document is issued by the Company subject to its General Conditions of Service printed overleaf, available on request or accessible at http://www.sgs.com/terms-and-conditions.aspx and, for electronic format documents, subject to Terms and Conditions for Electronic Documents at http://www.sgs.com/terms-and-conditions/Electronic-Document.aspx. Attention is drawn to the limitation of liability, indemnification and jurisdiction issues defined therein. Any holder of this document is advised that unless he/she expressly agrees to the Company's liability in the case of its interest only and within the limits of China's jurisdiction, it is the Company's sole responsibility to its Client and this document does not constitute a contract. In the absence of such express agreement, the Company's liability is limited to the extent of the services actually performed. The Company's liability is limited to the extent of the services actually performed. The Company's liability is limited to the extent of the services actually performed. The Company's liability is limited to the extent of the services actually performed.

Member of the SGS Group (SGS SA)



Test Report

No. SZXEC1900530401 Date: 30 Mar 2019 Page 2 of 6

Test Results :

Test Part Description :

Table with 3 columns: Specimen No., SGS Sample ID, Description. Row 1: SN1, SZX19-005304.001, Green"PCB"

Remarks :

- (1) 1 mg/kg = 1 ppm = 0.0001%
(2) MDL = Method Detection Limit
(3) ND = Not Detected (< MDL)
(4) "-" = Not Regulated

RoHS Directive (EU) 2015/863 amending Annex II to Directive 2011/65/EU

Test Method : With reference to IEC 62321-4:2013+A1:2017, IEC 62321-5:2013, IEC 62321-7-2:2017, IEC 62321-6:2015 and IEC 62321-8:2017, analyzed by ICP-OES, UV-Vis and GC-MS.

Table with 5 columns: Test Item(s), Limit, Unit, MDL, 0/1. Lists various substances like Cadmium, Lead, Mercury, Hexavalent Chromium, Sum of PBBs, etc. with their respective limits and detection results.



Unless otherwise agreed in writing, this document is issued by the Company subject to its General Conditions of Service printed overleaf, available on request or accessible at http://www.sgs.com/terms-and-conditions.aspx and, for electronic format documents, subject to Terms and Conditions for Electronic Documents at http://www.sgs.com/terms-and-conditions/Electronic-Document.aspx. Attention is drawn to the limitation of liability, indemnification and jurisdiction issues defined therein. Any holder of this document is advised that unless he/she expressly agrees to the Company's liability in the case of its interest only and within the limits of China's jurisdiction, it is the Company's sole responsibility to its Client and this document does not constitute a contract. In the absence of such express agreement, the Company's liability is limited to the extent of the services actually performed. The Company's liability is limited to the extent of the services actually performed. The Company's liability is limited to the extent of the services actually performed. The Company's liability is limited to the extent of the services actually performed.

Member of the SGS Group (SGS SA)



ZPMV2.E490354 - WIRING, PRINTED - COMPONENT

Wiring, Printed - Component

See General Information for Wiring, Printed - Component

O-LEADING SUPPLY CHAIN (HK) CO LTD
 ROOM 1205, 12/F
 TAI SANG BANK BLDG
 130-132 DES VOEUS ROAD
 CENTRAL, HONG KONG

E490354

Type	Cond Width		Cond Thk	SS/ DS/ DSO	Max	Max		Meets	C			
	Min	Edge			Area	Solder	Oper			Flame		
	mm(in)	mm(in)	mic(mil)		mm(in)	C	sec	C	Class	UL796	DSR	I
Multilayer (mass laminate) printed wiring boards.												
O-LEADING-401	0.1 (0.004)	0.3 (0.012)	34 (1.34)	DS	12.7 (0.5)	260	10	130	V-0	-	-	
O-LEADING-407	0.08 (0.003)	0.2 (0.008)	17 (0.67)	DS	9.7 (0.4)	260	10	130	V-0	All	-	
Multilayer printed wiring boards.												
O-LEADING-408	0.125 (0.005)	0.125 (0.005)	12 (0.47) Int:136	DS	50.8 (2.0)	280	20	130	V-0	All	*	
Single layer printed wiring boards.												
O-LEADING-002	0.38 (0.015)	1.14 (0.045)	34 (1.34)	SS	19.1 (0.8)	260	10	105	V-0	All	-	
O-LEADING-003	0.38 (0.015)	1.14 (0.045)	34 (1.34)	SS	19.1 (0.8)	260	10	130	V-0	▲	-	
O-LEADING-033	0.15 (0.006)	0.3 (0.012)	34 (1.34)	SS	25.4 (1.0)	260	10	120	V-0	All	-	
O-LEADING-205	0.1 (0.004)	0.3 (0.012)	34 (1.34)	DS	69.6 (2.7)	260	10	130	V-0	All	-	
O-LEADING-206	0.15 (0.006)	0.33 (0.013)	17 (0.67)	DS	69.6 (2.7)	260	10	130	V-0	All	-	
O-LEADING-D01	0.14 (0.006)	0.15 (0.006)	33 (1.30)	DS	25.4 (1.0)	260	10	130	V-0	All	*	
O-LEADING-S01	0.25 (0.010)	0.25 (0.010)	17 (0.67)	SS	25.4 (1.0)	260	4	130	V-0	All	*	

WIRING, PRINTED - COMPONENT | UL Product iQ

O-LEADING-S02	0.2 (0.008)	0.2 (0.008)	17 (0.67)	SS	25.4 (1.0)	260	4	130	HB	▲	*	
O-LEADING-S03	0.25 (0.010)	0.25 (0.010)	34 (1.34)	SS	25.4 (1.0)	260	4	130	V-0	All	*	

* - CTI marking is optional and may be marked on the printed wiring board.

Marking: Company name or file number and type designation. May be followed by a suffix to denote factory identification or burning test classification.

并不是所有出现在本数据库中的公司名称和产品都满足了UL跟踪检验服务的要求。只有带有UL标志的产品，才应该被视为经过UL认证，并满足UL跟踪检验服务的要求。注意查看产品上的标志。

UL 允许在线认证目录中所含材料的复制遵循以下条件：1.指南信息、装配、构造、设计、系统和/或认证（文件）必须在不篡改任何数据（或图纸）的情况下完整且无误导性地呈现。2.经UL允许从在线认证目录转载“声明必须出现在所摘录材料的邻近位置。此外，转载材料必须包含以下格式的版权声明：“© 2019 UL LLC”

Procesmogelijkheden

PCB-productiemogelijkheden

Aantal lagen	1Layer-32Layer
Afgewerkt koperdikte	1 / 3oz-12oz
Min Lijnbreedte / interne afstand	3.0mil / 3.0mil
Min Lijnbreedte / externe afstand	4,0 ml / 4,0 ml
Max. Beeldverhouding	10: 1
Board dikte	0,2 mm - 5,0 mm
Max Paneelgrootte (inch)	635 * 1500 mm
Minimale boorgatgrootte	4mil
Gepatenteerde gatentolerantie	+/- 3mil
Blind / Buried Vias (All-typen)	JA
Via vulling (geleidend, niet-geleidend)	JA
Basis materiaal	FR-4, FR-4high Tg, Halogeenvrij materiaal, Rogers, Aluminium basis, Polyimide, zwaar koper
Oppervlakteafwerkingen	HASL, OSP, ENIG, HAL-LF, Immersion zilver, Immersion Tin, gouden vingers, Carbon inkt

SMT-productiemogelijkheden

PCB-materiaal	FR-4, CEM-1, CEM-3, plaat op aluminiumbasis, FPC
Max PCB-afmeting	510x1500mm
Min PCB-afmeting	50x50mm
PCB-dikte	0,5 mm - 4,5 mm
Board dikte	0,5-4 mm
Min componenten grootte	0201
Standaard chipformaat component	0603 en groter
Max. Hoogte onderdeel	15 mm
Min. Voorsprong	0,3 mm
Min BGA-balhoogte	0,4 mm
Plaatsingsprecisie	+/- 0,03 mm

Verpakking en levering

Shipping service



Quick Turn Lead Time		
Layer Count:	Lead Tim	Special Requirement
1L/2L	2-3days	24 Hours,48 Hours
4L	3-4days	48 Hours
6L	4-5days	72 Hours
8L	5-6days	NA
10L	6-7days	NA
12L	7-8days	NA
14L	8-9days	NA

Standard Lead Time		
Layer Count:	Sample Lead Time	Volume order lead time
2L	4 days	10 days
4L	5 days	11 days
6L	6 days	12 days
8L	8 days	14 days
10L	10 days	16 days
12L	12 days	18 days
14L	14 days	20 days
16-32L	18 days	24 days

FAQ

1. Hoe garandeert O-Leading kwaliteit Onze hoge kwaliteitsstandaard wordt bereikt met het volgende.

- 1.1 Het proces wordt strikt gecontroleerd volgens de ISO 9001: 2008-normen.
- 1.2 Veel gebruik van software bij het beheer van het productieproces
- 1.3 State-of-art testapparatuur en gereedschappen. Bijv. Flying Probe, X-ray Inspection, AOI (Automated Optical Inspector) en ICT (in-circuit testing).
- 1.4 Specifiek kwaliteitsborgingsteam met analyseproces voor foutgevallen
- 1.5. Permanente opleiding en scholing van personeel

2. Hoe houdt O-Leading uw prijs concurrerend?

In de afgelopen tien jaar zijn de prijzen van veel grondstoffen (bijv. Koper, chemicaliën) verdubbeld, verdrievoudigd of verviervoudigd; De Chinese munteenheid RMB was 31% gestegen ten opzichte van de Amerikaanse dollar; En onze arbeidskosten zijn ook aanzienlijk gestegen. O-Leading heeft onze prijzen echter stabiel gehouden. Dit is volledig te danken aan onze innovaties in het verlagen van kosten, het vermijden van verspilling en het verbeteren van de efficiëntie. Onze prijzen zijn zeer concurrerend in de branche op hetzelfde kwaliteitsniveau. Wij geloven in een win-win-samenwerking met onze klanten. Ons partnerschap zal voor beide partijen

voordelig zijn als we u kosten en kwaliteit kunnen bieden.

3. Welke soorten borden kan O-Leading verwerken?

Veel voorkomende FR4-, high-TG- en halogeenvrije borden, Rogers, Arlon, Telfon, aluminium / koper-gebaseerde borden, PI, enz.

4. Welke gegevens zijn nodig voor de productie van PCB's en PCBA's?

4.1 BOM (Bill of Materials) met referentie-aanduidingen: componentbeschrijving, naam van de fabrikant en onderdeelnummer.

4.2 PCB Gerber-bestanden.

4.3 PCB-fabricagetekening en PCBA-assemblagetekening.

4.4 Testprocedures.

4.5 Eventuele mechanische beperkingen, zoals vereisten voor montagehoogte.

5. Wat is de typische processtroom voor meerlagige PCB's?

Materiaal snijden → Binnenste droge film → binnenste ets → Binnenste AOI → Multi-binding → Laagstapeling
Persen → Boren → PTH → Paneelbeplating → Buitenste droge film → Patroonbeplating → Buitenste etsing →
Buitenste AOI → Soldeermasker → Componentmarkering → Oppervlakteafwerking → Routing → E / T →
Visuele inspectie.

6. Wat is de belangrijkste uitrusting voor HDI-productie?

De belangrijkste apparatuurlijst is als volgt: laserboormachine, persmachine, VCP-lijn, automatische belichtingsmachine, LDI en etc. De apparatuur die we hebben is de beste in de branche, laserboormachines zijn van Mitsubishi en Hitachi, LDI-machines zijn van Screen (Japan), zijn automatische belichtingsmachines ook van Hitachi, waardoor we allemaal kunnen voldoen aan de technische eisen van de klant.

7. Hoeveel soorten oppervlakteafwerking kan O-lead doen?

O-the leader heeft de volledige reeks oppervlakteafwerkingen, zoals: ENIG, OSP, LF-HASL, gold plating (zacht / hard), immersion silver, tin, silver plating, immersion tin plating, carbon inkt en etc. .. OSP, ENIG, OSP + ENIG dat gewoonlijk wordt gebruikt op de HDI, raden we u meestal aan om een client of OSP OSP + ENIG te gebruiken als de BGA PAD-grootte kleiner is dan 0,3 mm.

8. Wat is uw vermogen voor FPC? Kan O-Leading ook SMT-service verlenen?

O-Leading kan FPC fabriceren van enkele laag tot 8 lagen, het werkpaneel kan zo groot zijn als 2000 mm * 240 mm, de details vindt u op de pagina "Flex-capaciteit". We bieden ook SMT one-stop-service aan de klant.

9. Wat zijn de belangrijkste factoren die de prijs van PCB's beïnvloeden?

Materiaal;

Oppervlakteafwerking;

Technologie moeilijkheid;

Verschillende kwaliteitscriteria;

PCB-kenmerken;

Betaalvoorwaarden;

Verschillende productielanden.

10. Wat is de definitie van PCB, PWB en FPC en wat is het verschil?

PCB is een afkorting voor Printed Circuit Board;

PWB is een afkorting voor Printed Wire Board, dezelfde betekenis als Printed Circuit Board;

FPC staat voor Flexible Printed Board.

11. Met welke factoren moet rekening worden gehouden bij het kiezen van het materiaal voor

een printplaat?

De onderstaande factoren moeten in overweging worden genomen bij het kiezen van het materiaal voor PCB:

De Tg-waarde van het materiaal moet hoger zijn dan de bedrijfstemperatuur;

Laag CTE-materiaal heeft goede prestaties van thermische stabiliteit;

Goede prestaties op het gebied van thermische weerstand: Normaal gesproken moeten PCB's gedurende ten minste 50 seconden bestand zijn tegen 250 s.

Goede vlakheid; Met het oog op de elektrische eigenschappen wordt materiaal met laag verlies / hoge permittiviteit gebruikt op hoogfrequente PCB's;

Polyimide glasvezelsubstraat gebruikt voor flexibele PCB; Metalen kern wordt gebruikt wanneer het product strikte warmtebehoefte heeft
dissipatie.

12. Wat zijn de voordelen van de stevige flexibele printplaat van O-leading?

De rigid-flex PCB van O-leading heeft de karakters van zowel FPC als PCB, dus het kan in sommige speciale producten worden gebruikt. Een deel is flexibel en het andere stijf, het kan helpen om de binnenruimte van het product te besparen, het productvolume te verminderen en de prestaties te verbeteren.

13. Hoe maakt u de impedantieberekening?

Het impedantiecontrolesysteem wordt gedaan met behulp van enkele testcoupons, de SI6000-soft en de CITS 500s-apparatuur van POLAR INSTRUMENTS. De apparatuur meet de impedantie op een representatieve spoorconfiguratiecoupon waarvan de klant ons een bepaalde waarde en tolerantie heeft gegeven.