





Keep *LEARNING*

There's a phrase in Buddhism, 'Beginner's mind.'

It's wonderful to have a beginner's mind

WE HAVE A *DREAM*

Keep *RUNNING*

I would like to live to study and not study to live.

---Bacon

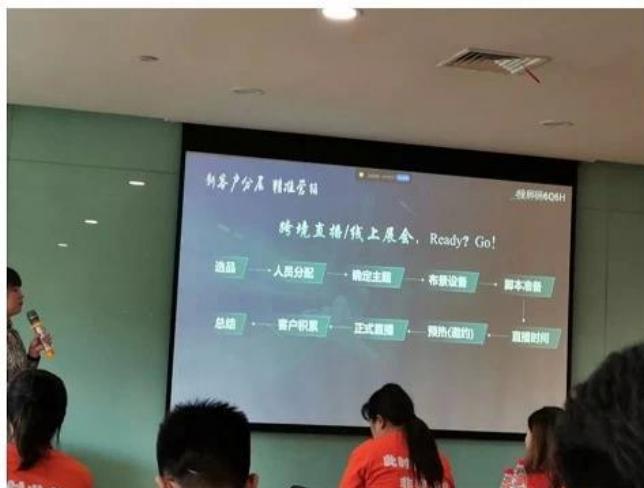

PCB PCB



TOP QUALITY PCBA

**O-LEADING**

To Be Reliable, To Be Valuable

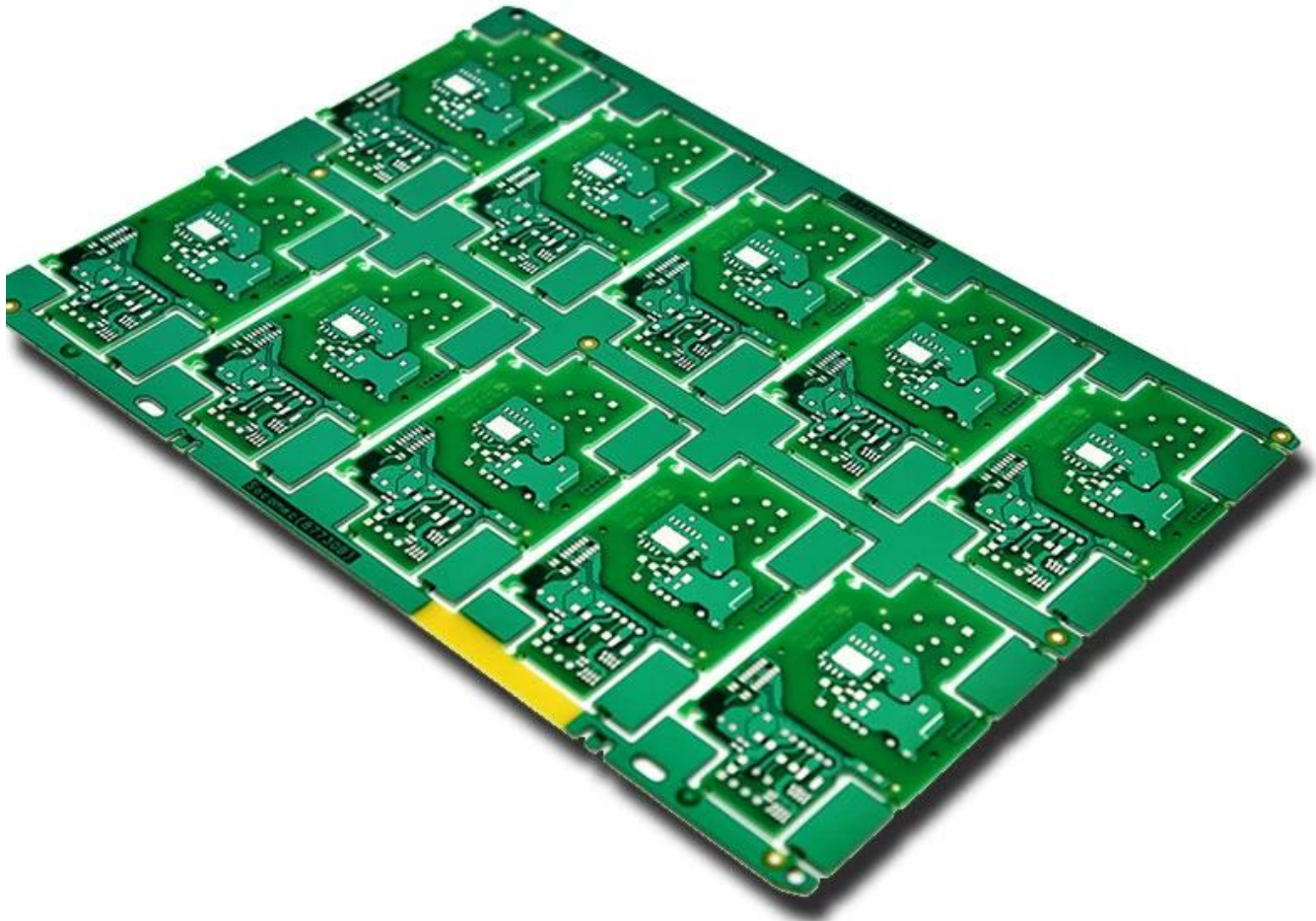

MAKE YOUR IDEA COME **TRUE**

TOP QUALITY PCBA

**O-LEADING**

To Be **Reliable**, To Be **Valuable**



MAKE YOUR IDEA COME **TRUE**



TOP QUALITY PCBA

**O-LEADING**

To Be Reliable, To Be Valuable

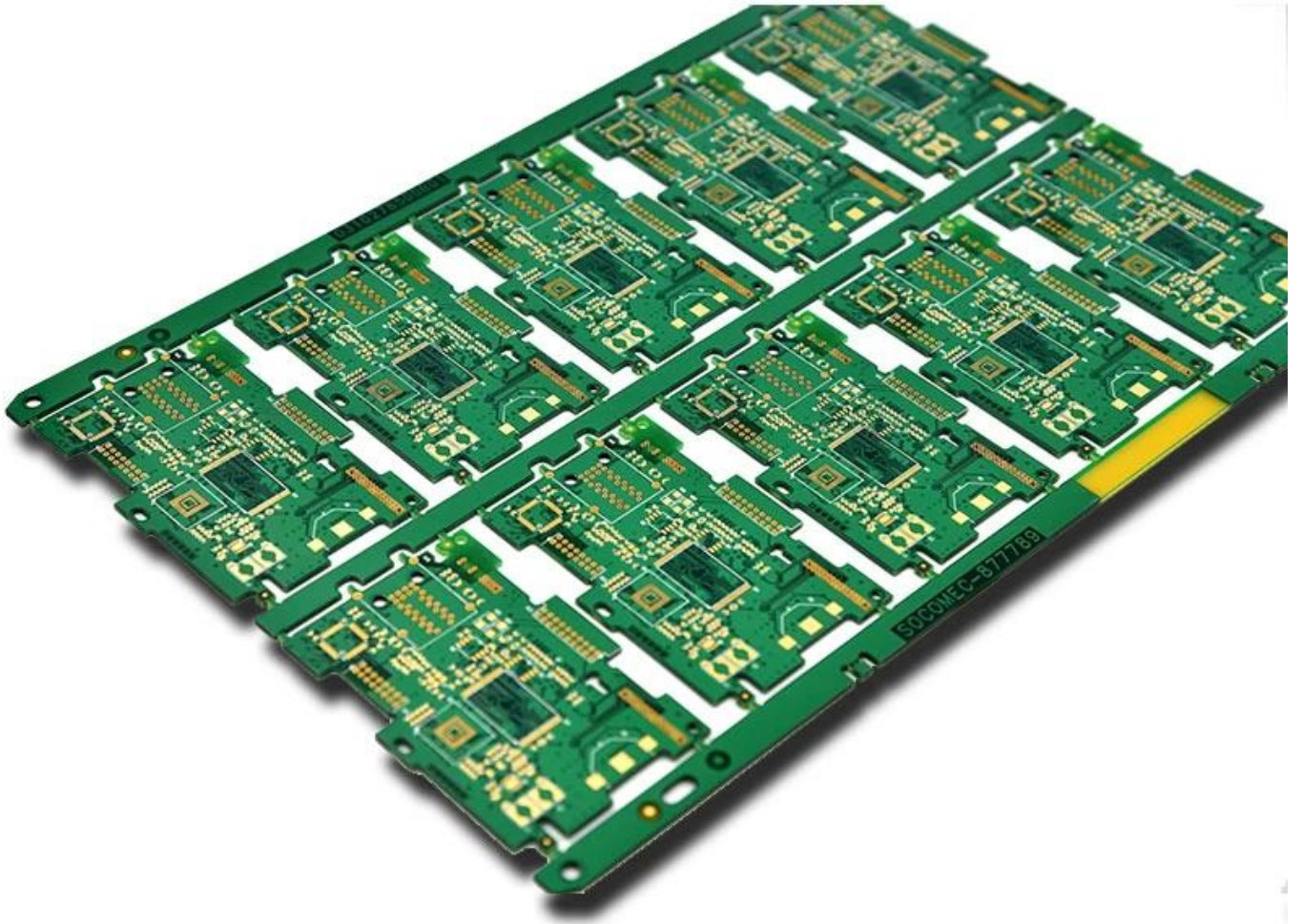

MAKE YOUR IDEA COME **TRUE**

TOP QUALITY PCBA

**O-LEADING**  
To Be Reliable, To Be Valuable

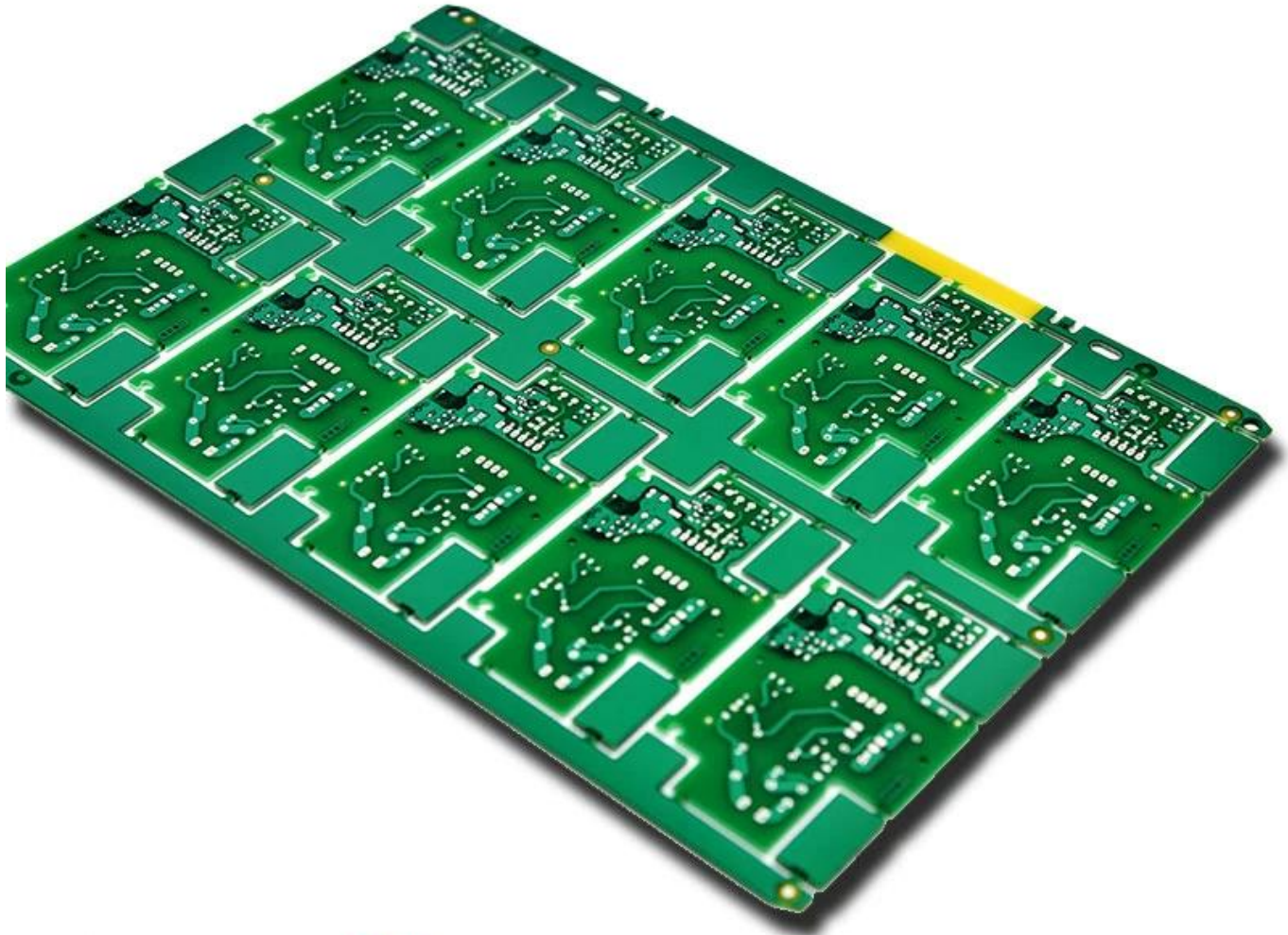

MAKE YOUR IDEA COME **TRUE**



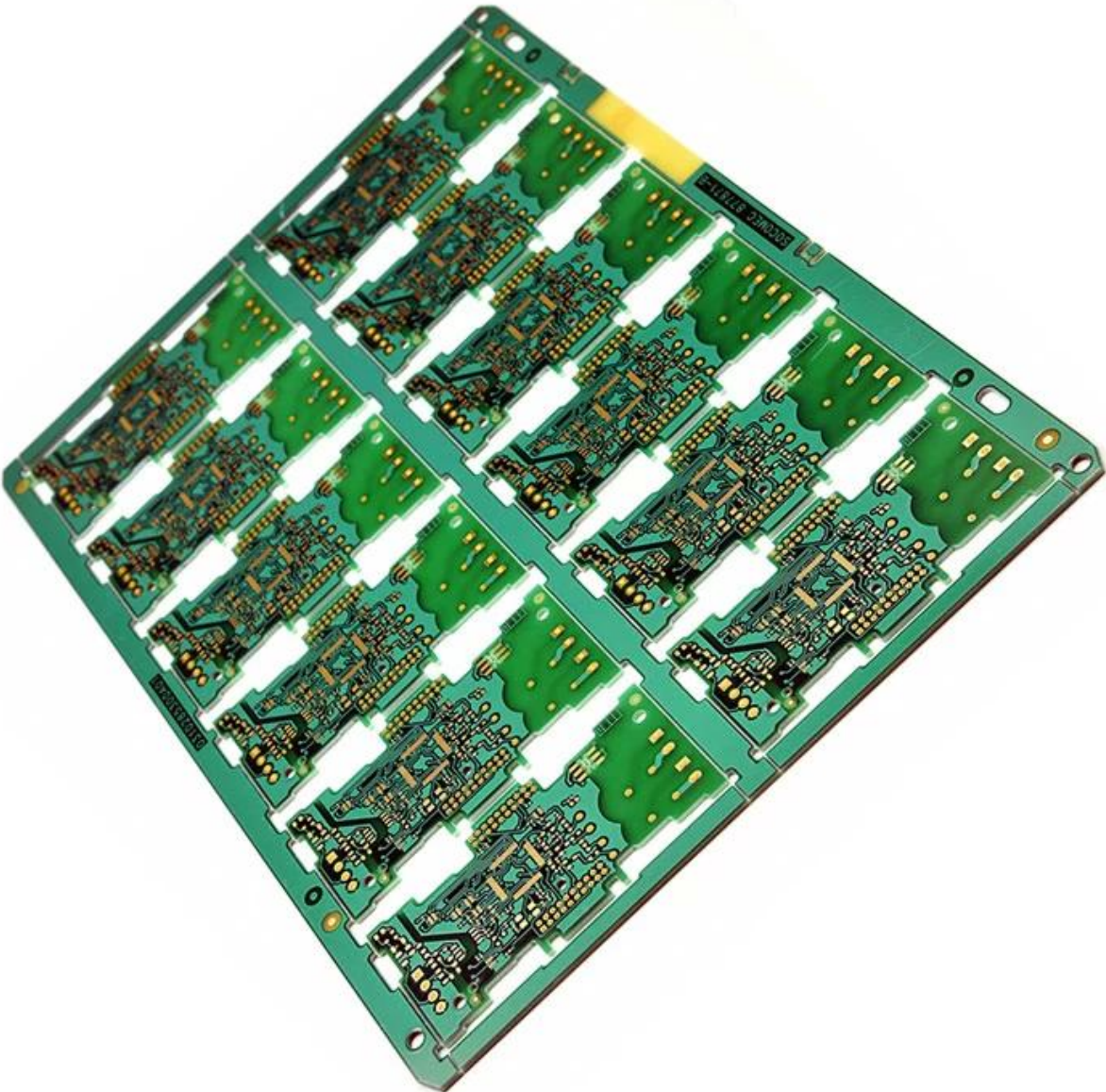

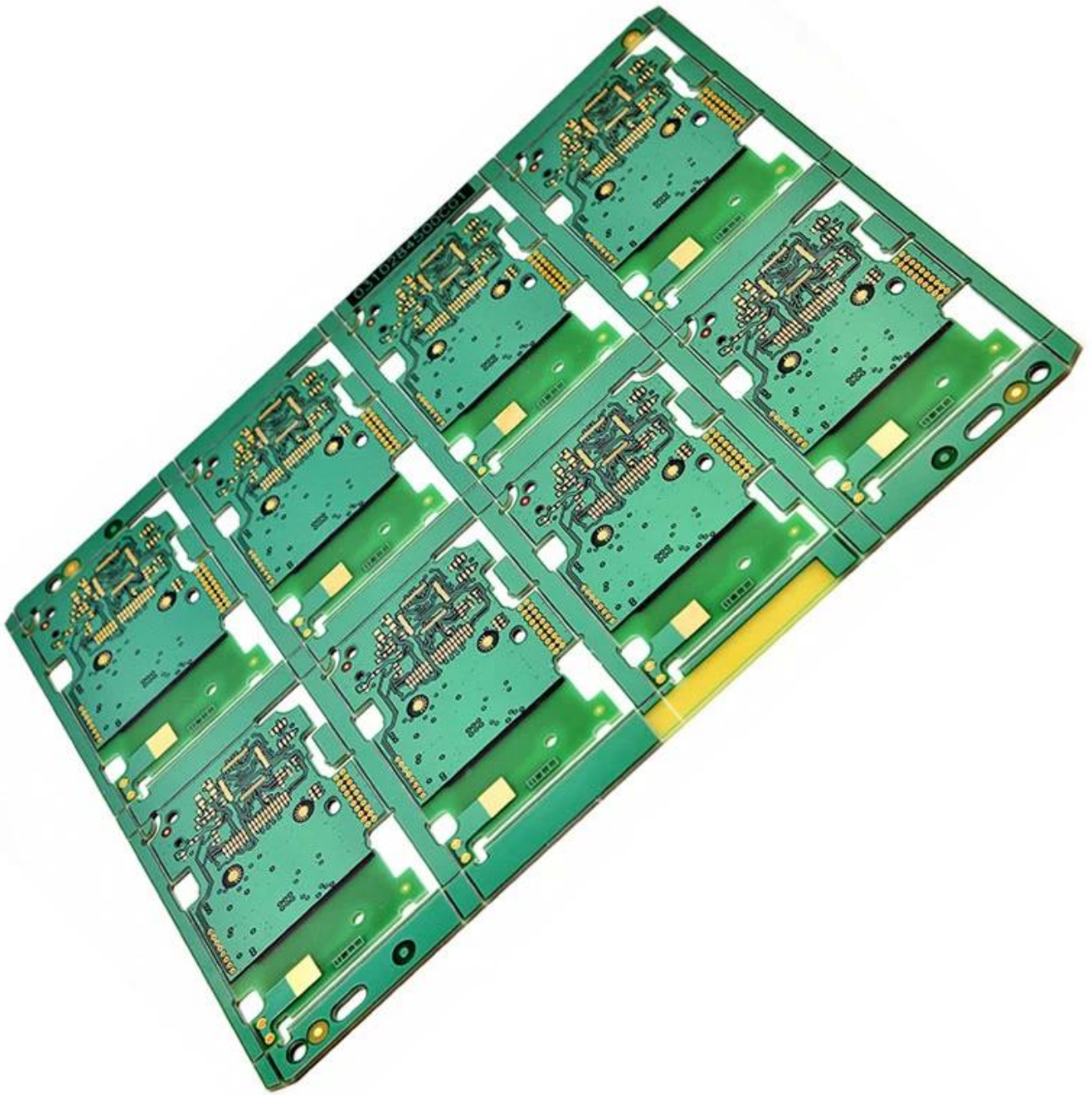



# Market Share

 CONSUMER ELECTRONICS

 AUTOMOTIVE ELECTRONICS

 INDUSTRIAL CONTROL

 INTELLECTUALIZED HOUSEHOLD CONTROL

 OTHER



**30%**  
CONSUMER ELECTRONICS

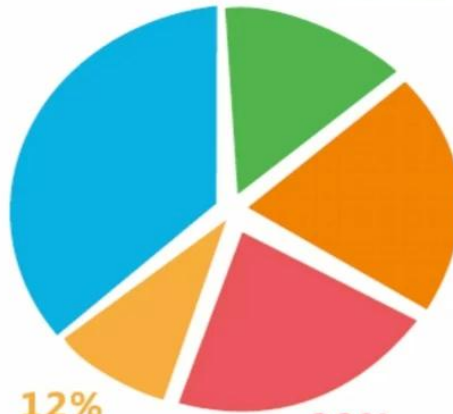

**18%**  
INTELLECTUALIZED HOUSEHOLD CONTROL

**20%**  
AUTOMOTIVE ELECTRONICS



**12%**  
OTHER

**20%**  
INDUSTRIAL CONTROL



## Product types

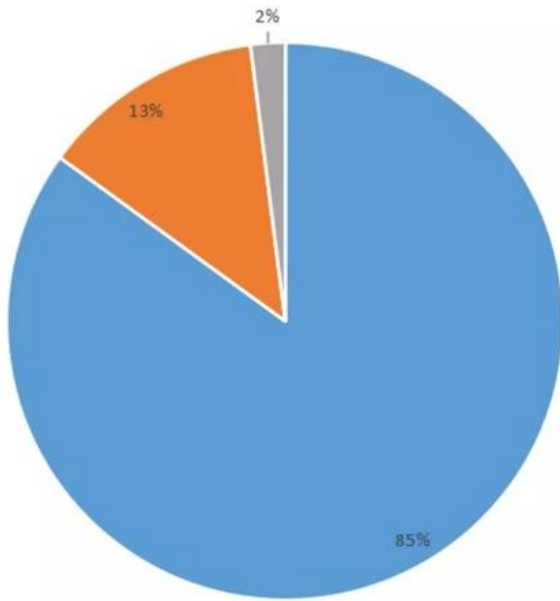

■ FR-4 PCB ■ MC PCB ■ rigid-flexible PCB

## Product layers

■ 1L ■ 2L ■ 4L ■ 6L ■ >8L

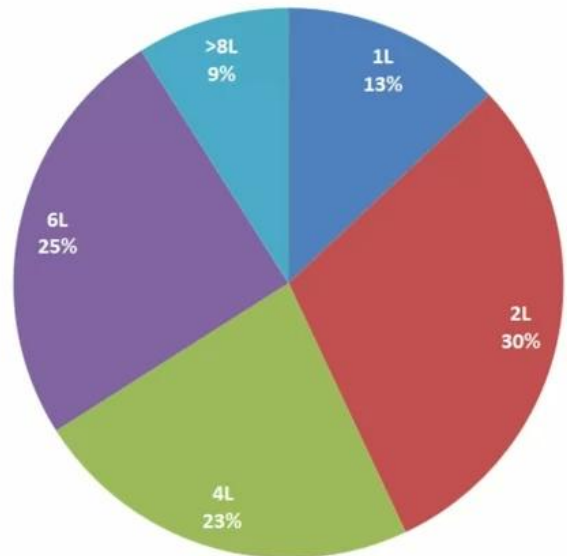



# Production Process

18 years experience in one-stop PCB and PCBA, we can make your idea come true,







---

Factory PCB

---



Automatic vacuum press machine



Drilling Machine



Pattern Plating Machine



Scrubbing Machine



Developing Machine



Routing Machine



High-speed flying probe machine



E-test Machine

---

Factory SMT

---



# HOW O-LEADING MAKE A PROJECT FOR YOU

Hardware Dispenser Application Not



## Automatic Dispenser Application Not

Voltage Table

Volt Pin Number	Description
VDD	Battery Voltage
+3V3	+3.3V
+5V	+5V
USB +5V	USB 5V input
+5V/2	Isolated +5V
+12V	12V DC Drive

STM32F072 PinOUT table

Wire Name	Description	DIO	Mode	Note
SM7N_TOF	Shutdown Time of flight sensor	Output	Logic '1' to shutdown	
I2C_SCL_TOF	I2C communication with time of flight sensor	I2C1_SCL		
I2C_SDA_TOF	I2C communication with thermopile sensor	I2C1_SDA		
I2C_SCL_IR	I2C communication with load cell control pins	I2C2_SCL		
I2C_SDA_IR		I2C2_SDA		
RATE_IC		Output		
DOUT_IC		Output		

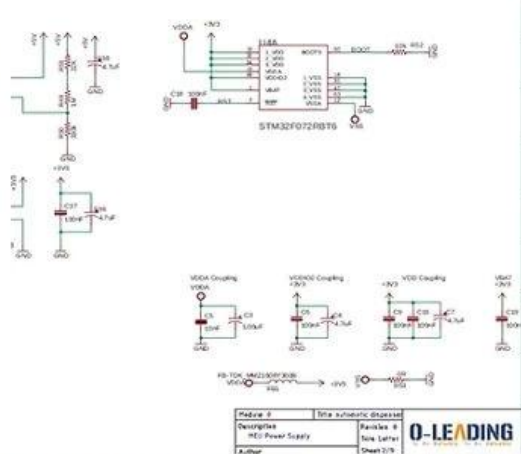

## HARDWARE schematics

## PCB PRODUCTION COMPONENTS SOURCING

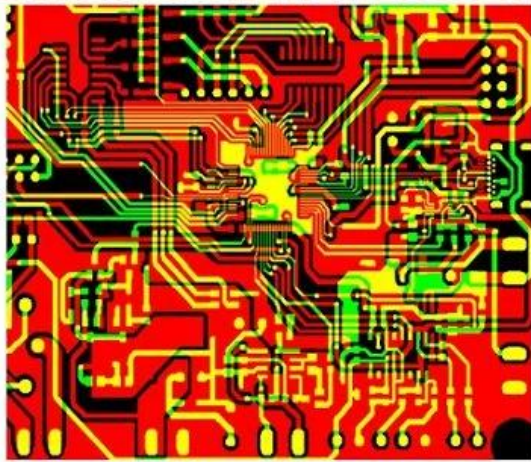

Qty	Value	Device	Parts	Description
4	AK500/1	AK500/2	X1, X2	CONNECTOR
1	AK500/3	AK500/3	X7	CONNECTOR
1	124114	MA04-2	SV2	
1	PPPC04	MA04-2	SV1	8 POS, 4*2 FEMALE PIN HEADE
1	ML10	ML10	SV4	HARTING
1	8MHZ	XTALL_CSTCE8M	X5	STCE8M00G52-R0 RESONATOR
1	0R	R-0603	R53	Thick Film Resistors - SMD 0603
2	10R	R-0603	R12, R5	Thick Film Resistors - SMD 0603
8	100R	R-0603	R1, R2	Thick Film Resistors - SMD 0603
1	270R	R-0805	R15	Thick Film Resistors - SMD 0605
1	330R	R-0603	R11	Thick Film Resistors - SMD 0603
9	680R	R-0603	R20, R3	Thick Film Resistors - SMD 0603
17	1k	R-0603	R9, R10	Thick Film Resistors - SMD 0603
2	4.7k	R-0603	R17, R6	Thick Film Resistors - SMD 0603
2	5.1k	R-0603	R18, R7	Thick Film Resistors - SMD 0603
9	10k	R-0603	R16, R3	Thick Film Resistors - SMD 0603

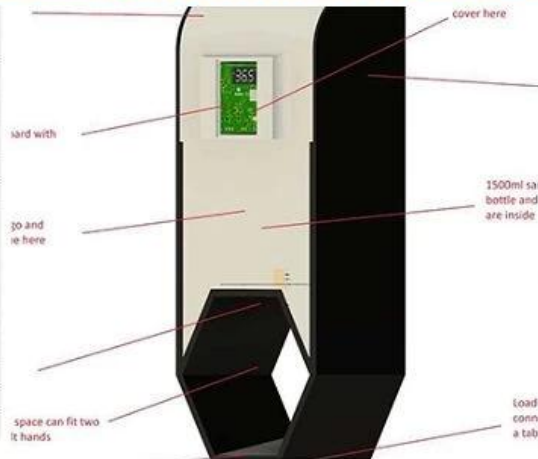

## PCB Assembly MECHANICAL DESIGN



**O-LEADING CUSTOMER**

To be **RELIABLE**

- Q**uality first ,
- C**ustomer supreme ,
- S**cientifically management ,
- S**triving for famous brand



**THE CUSTOMER IS KING**



To be **VALUABLE**

- S**cience and technology keeps head ,
- P**ut people first ,
- B**e precise and practical ,
- C**ontribute sincerely

Skyworth 创维

**HET** 和而泰  
HET INTELLIGENT CONTROL

dongweikeji  
东威科技

美的 Midea

STAR-NET  
星网锐捷

FORYOU  
ADAYO 华阳集团

**EDIFIER**<sup>®</sup>

Cultraview 金锐显

3nod 三诺

**T&W**

**TCL**

AcBel 康舒科技  
ACBEL POLYTECH INC.

**Honeywell**

Schneider  
Electric

**ZTE** 中兴

**EMERSON**

**BYD**

**PHILIPS**

**TE**  
connectivity

**VIDEOTON**

O-LEADING CUSTOMER REVIEW

CUSTOMER VOICE IS EXTREMELY IMPORTANT TO US

订单编号: 49335463501024670

供应商服务: 非常满意 (5 stars) 按时发货: 非常满意 (5 stars)



**High quality usb power pcb , pcba manufacturer**

★★★★★

Fancy has done an excellent job, whenever we write, she answered us within 1 second, O-leading is very perfect with fast delivery, fast logistics, the most important thing is good quality, good packaging, thank you!

[回复该评论](#)



**oem customized rohs pcb drawing schematic s...**

★★★★★

We received the boards, the quality is very good, the price is very reasonable, Fancy is very nice & smart & experienced, the logistics is super fast, I will come to see more in the future.

[回复该评论](#)

订单编号: 490224962001024670

供应商服务: 非常满意 (5 stars) 按时发货: 非常满意 (5 stars)



**High TG180 FR-4 Circuit HDI PCB 94V0 Board...**

★★★★★

This is a very efficient PCB design, but we are lucky to find O-leading to support the PCB for us, very good to a PCB supplier.



**universal FR4 Multilayer PCB washing machine...**

★★★★★

Fancy gives us very excellent service, very professional and experienced, O-leading is the best one of our suppliers, very happy to work with them.

订单编号: 49298271001024670

供应商服务: 非常满意 (5 stars) 按时发货: 非常满意 (5 stars)



**High TG180 FR-4 Circuit HDI PCB 94V0 Board ...**

★★★★★

perfect product, perfect PCB supplier!

[回复该评论](#)



**oem customized rohs pcb drawing schematic s...**

★★★★★

Very good and professional PCB product as usual!

[回复该评论](#)



**Strip LED Aluminum FR-4 lighting PCB board 9...**

★★★★★

High quality, fast delivery, good service, competitive price, lucky and happy to purchase from O-leading!

[回复该评论](#)

订单编号: 4093862201024670

供应商服务: 非常满意 (5 stars) 按时发货: 非常满意 (5 stars)



**High quality Keyboard pcb & pcba Factory SMT...**

★★★★★

Top quality, it's the right choice to choose O-leading to make the PCB & PCBA

[回复该评论](#)



**Professional Printed Circuit Board Manufactur...**

★★★★★

Very high quality PCB products, O-leading is the best PCB supplier that we have ever worked with.

订单编号: 44068794501024670

供应商服务: 非常满意 (5 stars) 按时发货: 非常满意 (5 stars)



**High TG180 FR-4 Circuit HDI PCB 94V0 Board ...**

★★★★★

We bought two batches, one by DHL, the other one by air, good quality and fast delivery!

LISTEN TO CUSTOMER VOICE

订单编号: 40903347501024670

供应商服务: 非常满意 (5 stars) 按时发货: 非常满意 (5 stars)



**Strip LED Aluminum FR-4 lighting PCB board 9...**

★★★★★

Very fast delivery! Fantastic, good job!!!



**Professional Printed Circuit Board Manufactur...**

★★★★★

Very happy to great support from O-leading, they are not only professional on the PCB, but also provide good PCB products, very good supplier!

订单编号: 36919647001024670

供应商服务: 非常满意 (5 stars) 按时发货: 非常满意 (5 stars)



**AML-S802 Quad-core Android embedded boar...**

★★★★★

Good products



**Fast delivery low cost pcb fabrication O-leadin...**

★★★★★

Good supplier

订单编号: 37378603001024670

供应商服务: 非常满意 (5 stars) 按时发货: 非常满意 (5 stars)



**hot sale rigid-flexible PCB with 0.2mm BGA an...**

★★★★★

very professional supplier



**High Quality custom FPCB/Flex PCB/FPC/Flexi...**

★★★★★

Good product



**OEM ODM PCBA Bluetooth Wireless Marking G...**

★★★★★

high soldering quality



**Electronic parts haptic pcba Circuit Board asse...**

★★★★★

Very Good product

订单编号: 37378603001024670

供应商服务: 非常满意 (5 stars) 按时发货: 非常满意 (5 stars)



**Lidar IR Sensor board pcba(H08R6x)**

★★★★★

perfect product



**Customized PCBA design PCB design**

★★★★★

perfect



**Audio Speaker and Headphone Jack (H07R3x)**

★★★★★

High quality, good

订单编号: 37378603001024670

供应商服务: 非常满意 (5 stars) 按时发货: 非常满意 (5 stars)



**Raspberry pi 0 Zero Raspberry Pi Zero PI W ver...**

★★★★★

Fantastic products!!



**double layer pcb with red S/M and LF-HASL su...**

★★★★★

Good!

订单编号: 37378603001024670

供应商服务: 非常满意 (5 stars) 按时发货: 非常满意 (5 stars)



**half hole pcb, half hole pcb module, half hole m...**

★★★★★

Top half hole pcb supplier, very perfect goods



**High Quality custom FPCB/Flex PCB/FPC/Flexi...**

★★★★★

this rigid-flexible pcb quality is perfect!



**Electronic parts haptic pcba Circuit Board asse...**

★★★★★

Very satisfied with O-leading products and quality, especially their on-time delivery, fantastic!

Be kind to your client, because he has many choices, but he chooses you instead.





C I C C INSPECTION CERTIFICATION



**嘉泰认证**

**QUALITY MANAGEMENT SYSTEM CERTIFICATE**

Certificate No: 18118Q10347R05

**We hereby certify that**

**O-LEADING SUPPLY CHAIN(HK) CO.,LIMITED**

Credit No: 61691591-000-07-18-7

Registration Add: FLAT/RM 1205 12/F TAI SANG BANK BUILDING 130-132 DES  
VOEUS BOAD CENTRAL HK

Business Add: 1313, Floor 13, Fortune Building, Danshui Town, Huiyang  
District, Huizhou, Guangdong, China

Has implemented and maintains a **Quality Management System**  
Which fulfils the requirements of the following standards  
GB/T19001-2016 idt ISO9001:2015

**Scope of certification**  
Sales of printed circuit boards

Initial issuance period: February 27, 2018  
Renewal date: April 22, 2019

This certificate is valid during: April 22, 2019 ~ February 26, 2021

This certificate is invalid without CICC qualified label in the following period

First supervision and audit	Second supervision and audit	Qualified mark
-----------------------------	------------------------------	----------------

The certification implementation scope does not include those production services which shall be obtained by the relevant effective administrative procedures and qualification procedures regulated by the state.  
The effectiveness of this certificate shall be notified by annual supervision audit of CICC the certificate shall be valid also need together with the surveillance audit certificate.  
The initial information of this certificate can be searched at the portal of CICC [www.cicc.com.cn](http://www.cicc.com.cn) or by the code of inquiry see below table.





C I C C INSPECTION CERTIFICATION



**嘉泰认证**

**质量管理体系认证证书**

证书号: 18118Q10347R05

**兹证明**

**诚领供应链(香港)有限公司**

统一社会信用代码: 61691591-000-07-18-7

注册地址: 香港中環德輔道中 130-132 號大生銀行大廈 1205 室

经营地址: 广东惠州惠阳淡水南亨西路财富大厦 13 楼 1313

**建立的质量管理体系符合**

**GB/T19001-2016 idt ISO9001:2015 质量标准适用条款的要求**

**认证范围**  
印刷线路板的销售

初次发证日期: 2018年02月27日

换证日期: 2019年04月22日

证书有效期: 自2019年04月22日至2021年02月26日

在下列期限内, 未经 CICC 黏贴合格标贴, 本证书无效

第一次监审	第二次监审	粘标处
-------	-------	-----

本证书认证范围不包括未获得有效的国家规定的行政许可、资质许可的产品/服务范围。  
本证书通过CICC定期监督审核保持, 与年度《保持认证通知书》共同方为有效。  
本证书信息可在国家认监委网站: [www.cnca.gov.cn](http://www.cnca.gov.cn)及CICC网站[www.cicc.com.cn](http://www.cicc.com.cn)查询。







Test Report

No. SZXEC1900530401 Date: 30 Mar 2019 Page 1 of 6

O-LEADING SUPPLY CHAIN (HK) CO., LIMITED

1313.FLOOR 13, FORTUNE BUILDING, DANSHUI TOWN, HUIYANG DISTRICT, HUIZHOU, GUANGDONG, CHINA

The following sample(s) was/were submitted and identified on behalf of the clients as : OSP

SGS Job No. : RP19-005089 - SZ
Date of Sample Received : 22 Mar 2019
Testing Period : 22 Mar 2019 - 30 Mar 2019
Test Requested : Selected test(s) as requested by client.
Test Method : Please refer to next page(s).
Test Results : Please refer to next page(s).

Conclusion : Based on the performed tests on submitted sample(s), the results of Lead, Mercury, Cadmium, Hexavalent chromium, Polybrominated biphenyls (PBBs), Polybrominated diphenyl ethers (PBDEs) and Phthalates such as Bis(2-ethylhexyl) phthalate (DEHP), Butyl benzyl phthalate (BBP), Dibutyl phthalate (DBP), and Diisobutyl phthalate (DIBP) comply with the limits as set by RoHS Directive (EU) 2015/863 amending Annex II to Directive 2011/65/EU.

Signed for and on behalf of
SGS-CSTC Standards Technical Services Co., Ltd. Shenzhen Branch

Tina
Tina Fan
Approved Signatory



Unless otherwise agreed in writing, this document is issued by the Company subject to its General Conditions of Service printed overleaf, available on request or accessible at http://www.sgs.com/terms-and-conditions.aspx and, for electronic format documents, subject to Terms and Conditions for Electronic Documents at http://www.sgs.com/terms-and-conditions/Electronic-Documents.aspx. Attention is drawn to the limitation of liability, indemnification and jurisdiction issues defined therein. Any holder of this document is advised that unless he/she expressly agrees to the Company's liability at the time of its intended use, the limits of the Company's liability are restricted to the extent of the Company's liability under the applicable law. This document does not constitute an offer of any financial product or service of the Company. Any disclaimer, limitation, survey or indemnification to the contrary appearing in this document is unlawful and offenders may be prosecuted to the fullest extent of the law. Unless otherwise stated the results shown in this report refer only to the samples tested.

Member of the SGS Group (SGS SA)



Test Report

No. SZXEC1900530401 Date: 30 Mar 2019 Page 2 of 6

Test Results :

Test Part Description :

Table with 3 columns: Specimen No., SGS Sample ID, Description. Row 1: SN1, SZX19-005304.001, Green"PCB"

Remarks :

- (1) 1 mg/kg = 1 ppm = 0.0001%
(2) MDL = Method Detection Limit
(3) ND = Not Detected (< MDL)
(4) "-" = Not Regulated

RoHS Directive (EU) 2015/863 amending Annex II to Directive 2011/65/EU

Test Method : With reference to IEC 62321-4:2013+A1:2017, IEC 62321-5:2013, IEC 62321-7-2:2017, IEC 62321-6:2015 and IEC 62321-8:2017, analyzed by ICP-OES, UV-Vis and GC-MS.

Table with 5 columns: Test Item(s), Limit, Unit, MDL, 0/1. Lists various substances like Cadmium, Lead, Mercury, Hexavalent Chromium, PBBs, PBDEs, and Phthalates with their respective limits and detection results.



Unless otherwise agreed in writing, this document is issued by the Company subject to its General Conditions of Service printed overleaf, available on request or accessible at http://www.sgs.com/terms-and-conditions.aspx and, for electronic format documents, subject to Terms and Conditions for Electronic Documents at http://www.sgs.com/terms-and-conditions/Electronic-Documents.aspx. Attention is drawn to the limitation of liability, indemnification and jurisdiction issues defined therein. Any holder of this document is advised that unless he/she expressly agrees to the Company's liability at the time of its intended use, the limits of the Company's liability are restricted to the extent of the Company's liability under the applicable law. This document does not constitute an offer of any financial product or service of the Company. Any disclaimer, limitation, survey or indemnification to the contrary appearing in this document is unlawful and offenders may be prosecuted to the fullest extent of the law. Unless otherwise stated the results shown in this report refer only to the samples tested.

Member of the SGS Group (SGS SA)



# ZPMV2.E490354 - WIRING, PRINTED - COMPONENT

## Wiring, Printed - Component

See General Information for Wiring, Printed - Component

**O-LEADING SUPPLY CHAIN (HK) CO LTD**  
 ROOM 1205, 12/F  
 TAI SANG BANK BLDG  
 130-132 DES VOEUS ROAD  
 CENTRAL, HONG KONG

E490354

Type	Cond Width		Cond Thk	SS/ DS/ DSO	Max Area Diam	Max Solder Limits		Max Oper Temp		Meets UL796	C
	Min	Edge				C	sec	C	Class		
	mm(in)	mm(in)	mic(mil)		mm(in)	C	sec	C	Class	DSR	I
<b>Multilayer (mass laminate) printed wiring boards.</b>											
O-LEADING-401	0.1 (0.004)	0.3 (0.012)	34 (1.34)	DS	12.7 (0.5)	260	10	130	V-0	-	-
O-LEADING-407	0.08 (0.003)	0.2 (0.008)	17 (0.67)	DS	9.7 (0.4)	260	10	130	V-0	All	-
<b>Multilayer printed wiring boards.</b>											
O-LEADING-408	0.125 (0.005)	0.125 (0.005)	12 (0.47) Int:136	DS	50.8 (2.0)	280	20	130	V-0	All	*
<b>Single layer printed wiring boards.</b>											
O-LEADING-002	0.38 (0.015)	1.14 (0.045)	34 (1.34)	SS	19.1 (0.8)	260	10	105	V-0	All	-
O-LEADING-003	0.38 (0.015)	1.14 (0.045)	34 (1.34)	SS	19.1 (0.8)	260	10	130	V-0	▲	-
O-LEADING-033	0.15 (0.006)	0.3 (0.012)	34 (1.34)	SS	25.4 (1.0)	260	10	120	V-0	All	-
O-LEADING-205	0.1 (0.004)	0.3 (0.012)	34 (1.34)	DS	69.6 (2.7)	260	10	130	V-0	All	-
O-LEADING-206	0.15 (0.006)	0.33 (0.013)	17 (0.67)	DS	69.6 (2.7)	260	10	130	V-0	All	-
O-LEADING-D01	0.14 (0.006)	0.15 (0.006)	33 (1.30)	DS	25.4 (1.0)	260	10	130	V-0	All	*
O-LEADING-S01	0.25 (0.010)	0.25 (0.010)	17 (0.67)	SS	25.4 (1.0)	260	4	130	V-0	All	*

WIRING, PRINTED - COMPONENT | UL Product iQ

O-LEADING-S02	0.2 (0.008)	0.2 (0.008)	17 (0.67)	SS	25.4 (1.0)	260	4	130	HB	▲	*
O-LEADING-S03	0.25 (0.010)	0.25 (0.010)	34 (1.34)	SS	25.4 (1.0)	260	4	130	V-0	All	*

\* - CTI marking is optional and may be marked on the printed wiring board.

Marking: Company name or file number and type designation. May be followed by a suffix to denote factory identification or burning test classification.

并不是所有出现在本数据库中的公司名称和产品都满足了UL跟踪检验服务的要求。只有带有UL标志的产品，才应该被视为经过UL认证，并满足UL跟踪检验服务的要求。注意查看产品上的标志。

UL 允许在线认证目录中所含材料的复制遵循以下条件：1.指南信息、装配、构造、设计、系统和/或认证（文件）必须在不篡改任何数据（或图纸）的情况下完整且无误导性地呈现。2.经UL允许从在线认证目录转载“声明必须出现在所提取材料的邻近位置。此外，转载材料必须包含以下格式的版权声明：“© 2019 UL LLC”





<b>PCB</b>	
Layer Count	1 - 32
Weight	1 / 3oz-12oz
Min. Thickness	3.0mil / 3.0mil
Max. Thickness	4.0mil / 4.0mil
Max Aspect Ratio	10 : 1
Min. Drill	0.2mm ~ 5.0mm
Min. Drill (Micro)	635 * 1500mm
Min. Drill (Micro)	400
Plated	+/- 3mil
Blind / Buried Via (All)	
Via Fill (Micro, Micro)	
Material	FR-4, FR-4high Tg, Epoxy, Polyimide, etc.
Surface Finish	HASL, OSP, ENIG, HAL-LF, Immersion silver, Immersion, etc.

### SMT

PCB	FR-4, CEM-1, CEM-3, etc.
PCB Size	510x1500mm
PCB Size	50x50mm
PCB Thickness	0.5mm ~ 4.5mm
Min. Drill	0.5-4mm
Min. Drill (Micro)	0201
Min. Drill (Micro)	0603
Min. Drill (Micro)	15mm
Min. Drill (Micro)	0.3mm
Min. BGA	0.4mm
Min. Drill	+/- 0.03mm



# Shipping service



Quick Turn Lead Time		
Layer Count:	Lead Tim	Special Requirement
1L/2L	2-3days	24 Hours,48 Hours
4L	3-4days	48 Hours
6L	4-5days	72 Hours
8L	5-6days	NA
10L	6-7days	NA
12L	7-8days	NA
14L	8-9days	NA

Standard Lead Time		
Layer Count:	Sample Lead Time	Volume order lead time
2L	4 days	10 days
4L	5 days	11 days
6L	6 days	12 days
8L	8 days	14 days
10L	10 days	16 days
12L	12 days	18 days
14L	14 days	20 days
16-32L	18 days	24 days



**1. O-Leading** 0000 0000 0000000?

- 1.1 000000 ISO 9001 : 2008 0000 00 000000 0000000.
- 1.2 00 000000 0000 00000000 000000 00
- 1.3 0000 0000 00 0 00. 0 : 0000 0000, X-ray 00, AOI (Automated Optical Inspector) 0 ICT (in-circuit testing).
- 1.4 00 00 00 000000 00 00 00 00 0
- 1.5. 000000 00 00 0 00

**2. O-Leading** 0000 00 000000 000000?

00 10 0 00 00 0000 (0 : 00, 00 00) 0000 0 0, 0 0 00 0 00000000. 00 00 RMB 00 00 00 31 % 00000000. 0000 000000 0 00000000.

0000 O-Leading 0000 000000 00000000. 0000 00 00, 00 00 0 0000 0000 00 0000 0000 000000 000000. 0000 0000 0000 00 0 0000 000000 00 000000 000000.

0000 000000 00 00000000 000000. 0000 000000 0000 0000 00 0 0000 0000 00000000 00 0000 0 000000.

**3. O-Leading** 00 0000 0000 00 0 0 00000?

00000 FR4, 0 TG 0 0000 00 00, Rogers, Arlon, Telfon, 00000 / 00 00 00, PI 0



**4. PCB 及 PCBA 的 主要 製造 過程 是 什麼?**

- 4.1 物料清單 BOM (Bill of Materials) : 物料清單, 物料清單 及 物料清單.
- 4.2 PCB Gerber 文件.
- 4.3 PCB 物料清單 及 PCBA 物料清單.
- 4.4 物料清單.
- 4.5 物料清單 物料清單 物料清單 物料清單.

**5. PCB 的 主要 製造 過程 是 什麼?**

物料清單 → 物料清單 物料清單 → 物料清單 → 物料清單 AOI → 物料清單 → 物料清單 物料清單 → 物料清單 → PTH → 物料清單 → 物料清單 物料清單 → 物料清單 → 物料清單 AOI → 物料清單 → 物料清單 → 物料清單 → 物料清單 → E / T → 物料清單.

**6. HDI 的 主要 製造 過程 是 什麼?**

物料清單 物料清單 物料清單 : 物料清單 物料清單, 物料清單, VCP 物料清單, 物料清單, LDI 物料清單 物料清單 物料清單 物料清單 物料清單 物料清單 Mitsubishi 物料清單 Hitachi物料清單, LDI 物料清單 Screen物料清單 物料清單. (物料清單), 物料清單 物料清單 物料清單 物料清單 物料清單 物料清單 物料清單 物料清單.

**7. 物料清單 物料清單 物料清單 O- 物料清單 物料清單?**

O-the 物料清單 ENIG, OSP, LF-HASL, 物料清單 (物料清單 / 物料清單), 物料清單, 物料清單, 物料清單 物料清單, 物料清單 物料清單 物料清單 物料清單 物料清單 物料清單. HDI物料清單 物料清單 物料清單 OSP, ENIG, OSP + ENIG, BGA PAD 物料清單 0.3mm 物料清單 物料清單 物料清單 物料清單 物料清單 OSP OSP + ENIG 物料清單 物料清單.

**8. FPC 的 主要 製造 過程 是 什麼? O-Leading SMT 物料清單 物料清單?**

O-Leading物料清單 物料清單 8 物料清單 FPC物料清單 物料清單 物料清單. 物料清單 物料清單 物料清單 2000mm \* 240mm物料清單 物料清單. 物料清單 物料清單“Flex Capability”物料清單 物料清單. 物料清單 物料清單 SMT 物料清單 物料清單 物料清單.

**9. PCB 物料清單 物料清單 物料清單 物料清單 物料清單?**

- 物料清單;
- 物料清單;
- 物料清單;
- 物料清單 物料清單;
- PCB 物料清單;
- 物料清單;
- 物料清單 物料清單.

**10. PCB, PWB 及 FPC 物料清單 物料清單 物料清單 物料清單?**

PCB物料清單 物料清單 物料清單 物料清單.  
PWB物料清單 Printed Wire Board物料清單 物料清單 物料清單 物料清單 物料清單.  
FPC物料清單 Flexible Printed Board物料清單 物料清單.

**11. PCB 物料清單 物料清單 物料清單 物料清單 物料清單?**

PCB 物料清單 物料清單 物料清單 物料清單 物料清單.  
物料清單 Tg 物料清單 物料清單 物料清單.  
物料清單 CTE 物料清單 物料清單 物料清單.  
物料清單 物料清單 物料清單 : 物料清單 PCB物料清單 物料清單 50 物料清單 250 °C物料清單 物料清單 物料清單.  
物料清單 物料清單; 物料清單 物料清單 物料清單 PCB物料清單 物料清單 / 物料清單 物料清單 物料清單.  
物料清單 PCB物料清單 物料清單 物料清單 物料清單 物料清單; 物料清單 物料清單 物料清單 物料清單 物料清單 物料清單 物料清單.  
物料清單.

**12. O-leading rigid-flex PCB 物料清單 物料清單?**

O-leading物料清單 rigid-flex PCB物料清單 FPC物料清單 PCB物料清單 物料清單 物料清單 物料清單 物料清單 物料清單 物料清單. 物料清單 物料清單 物料清單 物料清單 物料清單 物料清單 物料清單 物料清單.

**13. 物料清單 物料清單 物料清單?**

物料清單 物料清單 POLAR INSTRUMENTS物料清單 物料清單 物料清單, SI6000 物料清單 物料清單 CITS 500s 物料清單 物料清單 物料清單. 物料清單 物料清單 物料清單 物料清單.

□ □□□ □□ □□ □□□ □ □ □□□□ □□ □□ □□□□ □□□□□.