

O-leading

O-Leading PCB PCB PCB EMS HDIPCB PCB PCB PCB

O

O-leading PCB PCBA

O-LEADING
To Be Reliable, To Be Valuable

WE ALWAYS PROVIDE YOU

BEST HIGH DENSITY INTERCONNECT PCB

WE ALWAYS PROVIDE YOU

BEST RIGID-FLEXIBLE CIRCUIT

Raspberry Pi3 A + Raspberry Pi 3B + Raspberry Pi PCB

□□□□

RAM 512MB USB Raspberry Pi 3 Model A +

Raspberry Pi 3 Model A + Raspberry Pi 3B +

* 1.4GHz 64-bit ARM Cortex-A53 CPU

* 512MB LPDDR2 SDRAM

* 802.11ac LAN Bluetooth 4.2 / BLE

* USB

*

FCC



TOP QUALITY PCBA
O-LEADING
To Be Reliable, To Be Valuable



MAKE YOUR IDEA COME TRUE

□□

- * Broadcom BCM2837B0 Cortex-A53 ARMv8 64-bit SoC @ 1.4GHz
- * 512MB LPDDR2 SDRAM
- * 2.4GHz / 5GHz IEEE 802.11.b / g / n / ac LAN Bluetooth 4.2 / BLE
- * 40 GPIO
- * HDMI
- * USB2.0
- * Raspberry Pi CSI
- * Raspberry Pi DSI
- * 4
- * SD
- * 5V / 2.5ADC



TOP QUALITY PCBA
O-LEADING
 To Be Reliable, To Be Valuable



MAKE YOUR IDEA COME TRUE



TOP QUALITY PCBA

O-LEADING
To Be **Reliable**, To Be **Valuable**



MAKE YOUR IDEA COME **TRUE**

TOP QUALITY PCBA

O-LEADING
To Be **Reliable**, To Be **Valuable**

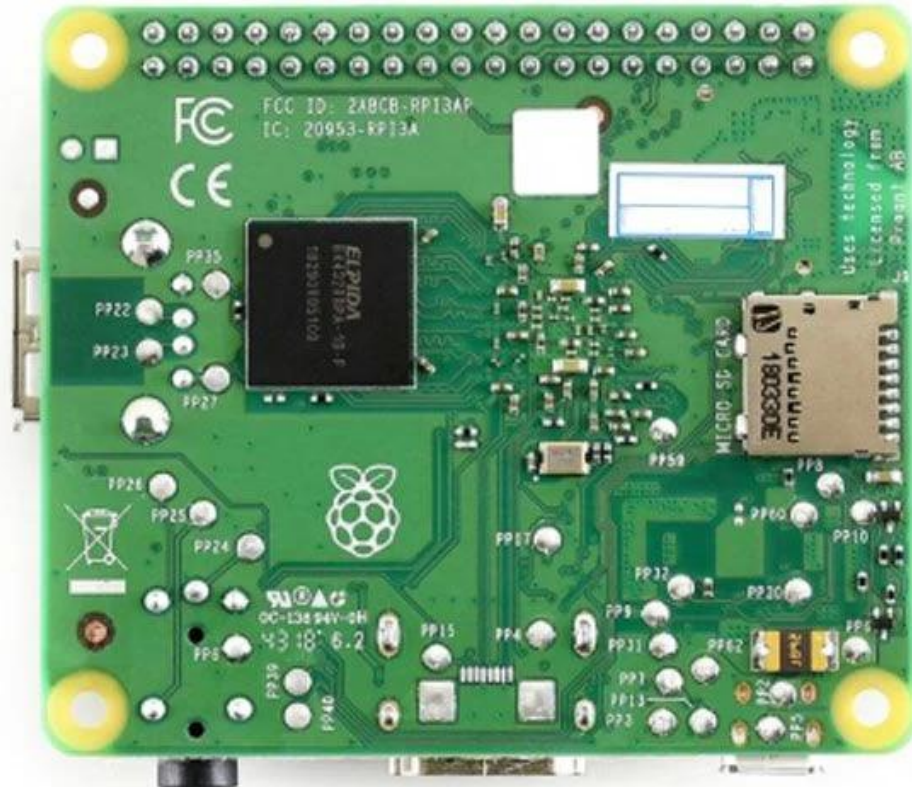

MAKE YOUR IDEA COME **TRUE**

TOP QUALITY PCBA

O-LEADING
To Be Reliable, To Be Valuable

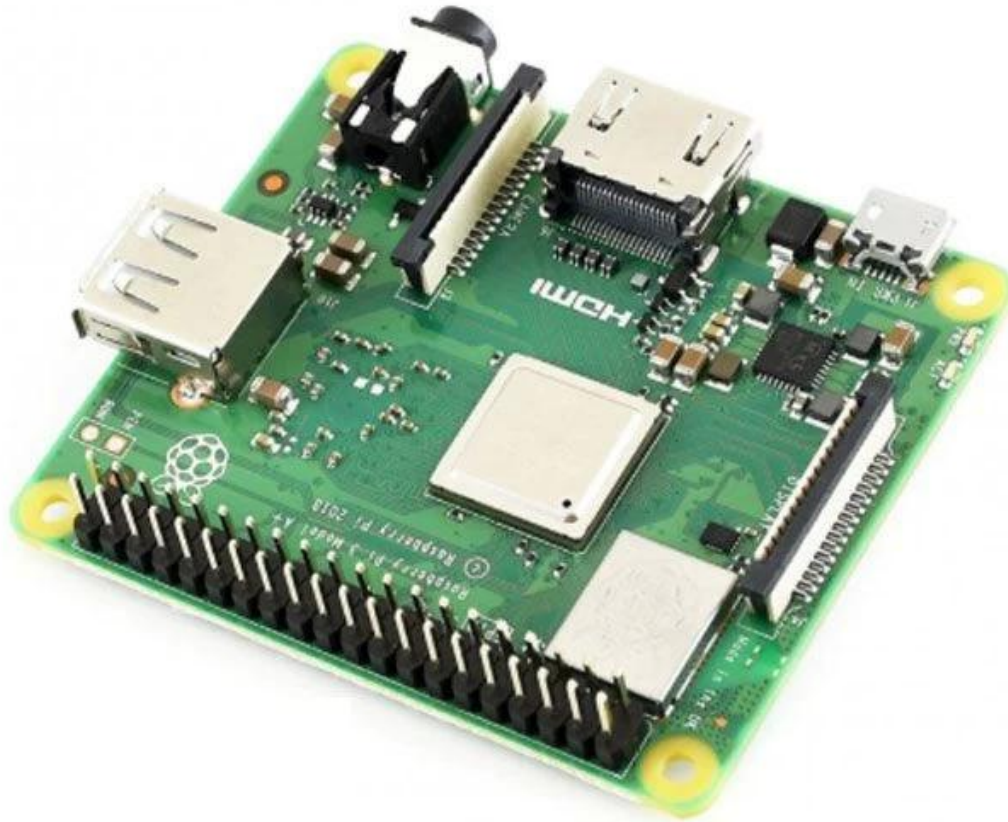

MAKE YOUR IDEA COME **TRUE**



O-LEADING CUSTOMER

To be **RELIABLE**

- Q**uality first ,
- C**ustomer supreme ,
- S**cientifically management ,
- S**triving for famous brand



THE CUSTOMER IS KING



To be **VALUABLE**

- S**cience and technology keeps head ,
- P**ut people first ,
- B**e precise and practical ,
- C**ontribute sincerely

Factory PCB



Automatic vacuum press machine



Drilling Machine



Pattern Plating Machine



Scrubbing Machine



Developing Machine



Routing Machine



High-speed flying probe machine



E-test Machine

Factory SMT



HOW O-LEADING MAKE A PROJECT FOR YOU

Hardware Dispenser Application Not

Automatic Dispenser Application Not

Voltage Table

Volt Pin Number	Description
VDD	Battery voltage
+3V3	+3.3V
+5V	+5V
USB +5V	USB 5V input
+5V/2	Isolated +5V
+12V	12V DC Drive

STM32F072 PINOUT table

Wire Name	Description	DIO	Mode	Note
SMTN_TOF	Shutdown Time of flight sensor	Output	Logic '0' to shutdown	
I2C_SCL_TOF	I2C communication with time of flight sensor	I2C1_SCL		
I2C_SDA_TOF	I2C communication with thermopile sensor	I2C1_SDA		
I2C_SCL_IR	I2C communication with thermopile sensor	I2C2_SCL		
I2C_SDA_IR	I2C communication with thermopile sensor	I2C2_SDA		
RATE_LC	Load cell control pins	Output		
DOUT_LC	Load cell control pins	Output		

O-LEADING
TO BE RELIABLE, TO BE AVAILABLE

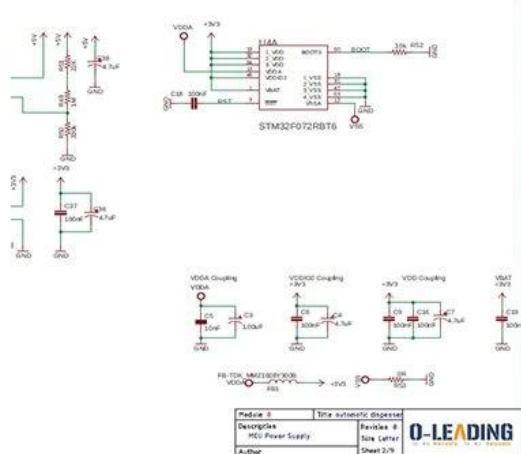

HARDWARE schematics

PCB PRODUCTION COMPONENTS SOURCING

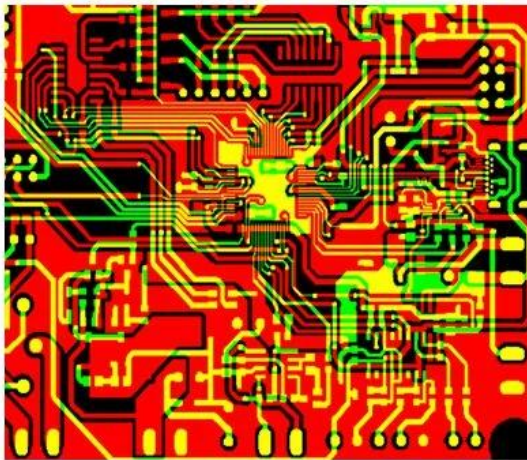

Qty	Value	Device	Parts	Description
4	AK500/2	AK500/2	X1, X2	CONNECTOR
1	AK500/3	AK500/3	X7	CONNECTOR
1	1241148	MA04-2	SV2	
1	PPPC04	MA04-2	SV1	8 POS, 4*2 FEMALE PIN HEAD
1	ML10	ML10	SV4	HARTING
1	8MHZ	XTALL_CSTCE8M	X5	STCE8M00G52-R0 RESONATOR
1	0R	R-0603	R53	Thick Film Resistors - SMD 0603
2	10R	R-0603	R12, R5	Thick Film Resistors - SMD 0603
8	100R	R-0603	R1, R2	Thick Film Resistors - SMD 0603
1	270R	R-0805	R15	Thick Film Resistors - SMD 0605
1	330R	R-0603	R11	Thick Film Resistors - SMD 0603
9	680R	R-0603	R20, R3	Thick Film Resistors - SMD 0603
17	1k	R-0603	R9, R10	Thick Film Resistors - SMD 0603
2	4.7k	R-0603	R17, R6	Thick Film Resistors - SMD 0603
2	5.1k	R-0603	R18, R1	Thick Film Resistors - SMD 0603
9	10k	R-0603	R16, R3	Thick Film Resistors - SMD 0603

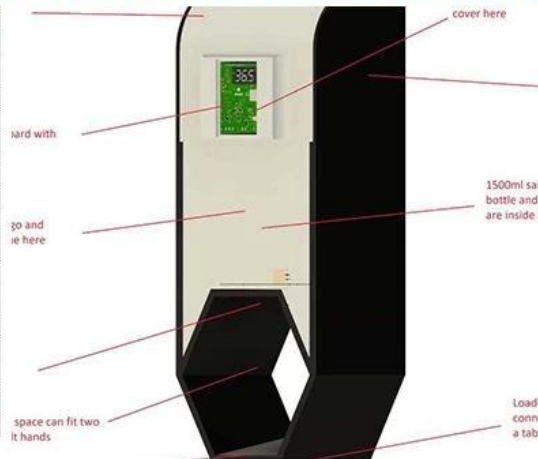
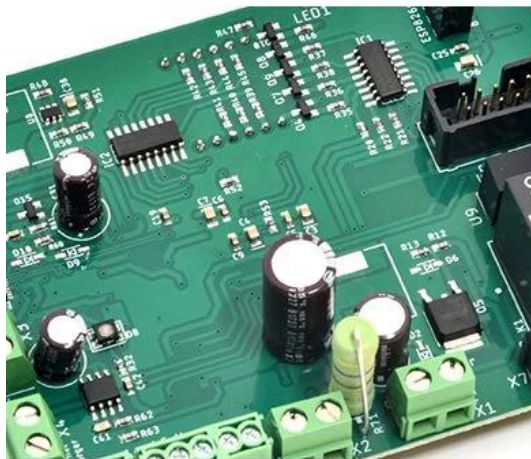

PCB Assembly MECHANICAL DESIGN

Skyworth 创维

HET 和而泰
HET INTELLIGENT CONTROL

dongweikeji
东威科技

美的 Midea

STAR-NET
星网锐捷

FORYOU
ADAYO 华阳集团

EDIFIER[®]

Cultraview 金锐显

3nod 三诺

T&W

TCL

AcBel 康舒科技
ACBEL POLYTECH INC.

Honeywell

Schneider
Electric

ZTE 中兴

EMERSON

BYD

PHILIPS

TE
connectivity

VIDEOTON

CUSTOMER VOICE IS **EXTREMELY IMPORTANT** TO US

订单编号: 49335463501024670

供应商服务: 非常满意 (5 stars) 按时发货: 非常满意 (5 stars)



High quality usb power pcb , pcba manufacturer

★★★★★

Fancy has done an excellent job, whenever we write, she answered us within 1 second, O-leading is very perfect with fast delivery, fast logistics, the most important thing is good quality, good packaging, thank you!

[回复该评论](#)



oem customized rohs pcb drawing schematic s...

★★★★★

We received the boards, the quality is very good, the price is very reasonable, Fancy is very nice & smart & experienced, the logistics is super fast, I will come to see more in the future.

[回复该评论](#)

订单编号: 4932411001024670

供应商服务: 非常满意 (5 stars) 按时发货: 非常满意 (5 stars)



High TG180 FR-4 Circuit HDI PCB 94V0 Board...

★★★★★

This is a very difficult PCB design, but we are lucky to find O-leading to support the PCB for us very good to a PCB supplier.



universal FR4 Multilayer PCB washing machine...

★★★★★

Fancy gives us very excellent service, very professional and experienced, O-leading is the best one of our suppliers, very happy to work with them.

订单编号: 49298271001024670

供应商服务: 非常满意 (5 stars) 按时发货: 非常满意 (5 stars)



High TG180 FR-4 Circuit HDI PCB 94V0 Board ...

★★★★★

perfect product, perfect PCB supplier!

[回复该评论](#)



oem customized rohs pcb drawing schematic s...

★★★★★

Very good and professional PCB product as usual!

[回复该评论](#)

订单编号: 49024962001024670

United States
供应商服务: 非常满意 (5 stars) 按时发货: 非常满意 (5 stars)



High quality Keyboard pcb & pcba Factory SMT...

★★★★★

Top quality, it's the right choice to choose O-leading to make the PCB & PCBA

[回复该评论](#)

订单编号: 493862201024670

供应商服务: 非常满意 (5 stars) 按时发货: 非常满意 (5 stars)



Professional Printed Circuit Board Manufactur...

★★★★★

Very high quality PCB products, O-leading is the best PCB supplier that we have ever worked with.

订单编号: 44068794501034670

供应商服务: 非常满意 (5 stars) 按时发货: 非常满意 (5 stars)



High TG180 FR-4 Circuit HDI PCB 94V0 Board ...

★★★★★

We bought two batches, one by DHL, the other one by air, good quality and fast delivery!

LISTEN TO **CUSTOMER VOICE**

订单编号: 40903347501024670

供应商服务: 非常满意 (5 stars) 按时发货: 非常满意 (5 stars)



Strip LED Aluminum FR-4 lighting PCB board 9...

★★★★★

Very fast delivery! Fantastic, good job!!



Professional Printed Circuit Board Manufactur...

★★★★★

Very happy to great support from O-leading, they are not only professional on the PCB, but also provide good PCB products, very good supplier!

订单编号: 36919647001024670

供应商服务: 非常满意 (5 stars) 按时发货: 非常满意 (5 stars)



AML-S802 Quad-core Android embedded boar...

★★★★★

Good products



Fast delivery low cost pcb fabrication O-leadin...

★★★★★

Good supplier

订单编号: 37378603001024670

供应商服务: 非常满意 (5 stars) 按时发货: 非常满意 (5 stars)



hot sale rigid-flexible PCB with 0.2mm BGA an...

★★★★★

very professional supplier



High Quality custom FPCB/Flex PCB/FPC/Flexi...

★★★★★

Good product



OEM ODM PCBA Bluetooth Wireless Marking G...

★★★★★

high soldering quality



Electronic parts haptic pcba Circuit Board asse...

★★★★★

Very Good product

订单编号: 36919647001024670

供应商服务: 非常满意 (5 stars) 按时发货: 非常满意 (5 stars)



Lidar IR Sensor board pcba(H08R6x)

★★★★★

perfect product



Customized PCBA design PCB design

★★★★★

perfect



Audio Speaker and Headphone Jack (H07R3x)

★★★★★

High quality, good

订单编号: 37378603001024670

供应商服务: 非常满意 (5 stars) 按时发货: 非常满意 (5 stars)



Raspberry pi 0 Zero Raspberry Pi Zero PI W ver...

★★★★★

Fantastic products!!





double layer pcb with red S/M and LF-HASL su...

★★★★★

Good!

订单编号: 36919647001024670

供应商服务: 非常满意 (5 stars) 按时发货: 非常满意 (5 stars)



half hole pcb, half hole pcb module, half hole m...

★★★★★

Top half hole pcb supplier, very perfect goods



High Quality custom FPCB/Flex PCB/FPC/Flexi...

★★★★★

this rigid-flexible pcb quality is perfect!



Electronic parts haptic pcba Circuit Board asse...

★★★★★

Very satisfied with O-leading products and quality, especially their on-time delivery, fantastic!

Be **kind** to your client, because he has many choices, but he chooses you instead.



O-LEADING TRAINING



Keep *LEARNING*

There's a phrase in Buddhism, 'Beginner's mind.'

It's wonderful to have a beginner's mind

WE HAVE A *DREAM*

Keep *RUNNING*

I would like to live to study, and not study to live.

----Bacon

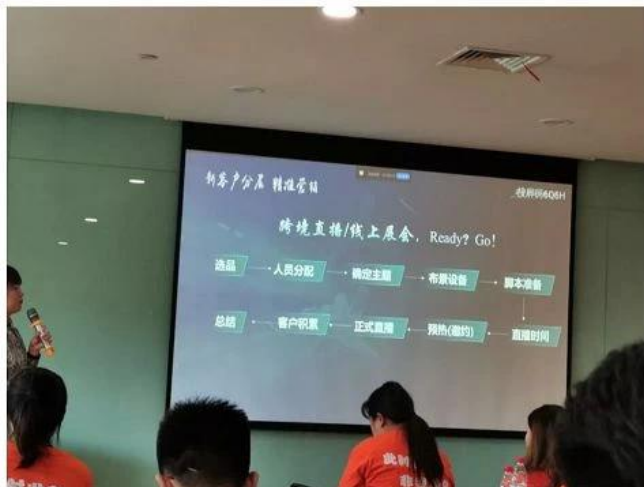



Test Report No. SZXEC1900530401 Date: 30 Mar 2019 Page 1 of 6

O-LEADING SUPPLY CHAIN (HK) CO., LIMITED
1313.FLOOR 13, FORTUNE BUILDING, DANSHUI TOWN, HUIYANG DISTRICT, HUIZHOU, GUANGDONG, CHINA

The following sample(s) was/were submitted and identified on behalf of the clients as : OSP

SGS Job No. : RP19-005089 - SZ
Date of Sample Received : 22 Mar 2019
Testing Period : 22 Mar 2019 - 30 Mar 2019
Test Requested : Selected tests(s) as requested by client.
Test Method : Please refer to next page(s).
Test Results : Please refer to next page(s).

Conclusion : Based on the performed tests on submitted sample(s), the results of Lead, Mercury, Cadmium, Hexavalent chromium, Polybrominated biphenyls (PBBs), Polybrominated diphenyl ethers (PBDEs) and Phthalates such as Bis(2-ethylhexyl) phthalate (DEHP), Butyl benzyl phthalate (BBP), Dibutyl phthalate (DBP), and Diisobutyl phthalate (DIBP) comply with the limits as set by RoHS Directive (EU) 2015/863 amending Annex II to Directive 2011/65/EU.

Signed for and on behalf of
SGS-CSTC Standards Technical Services Co., Ltd. Shenzhen Branch

Tina
Tina Fan
Approved Signatory



Unless otherwise agreed in writing, this document is issued by the Company subject to its General Conditions of Service printed on the reverse side of this document or available at <http://www.sgs.com>. The Client's attention is drawn to the limitation of liability, indemnification and jurisdiction issues defined therein. Any holder of this document is advised that information contained herein reflects the Company's findings at the time of its intervention only and within the limits of the Client's instructions. In any event, the Company's sole responsibility is to its Client and the document does not exonerate parties to a transaction from respecting all their rights and obligations under the transaction documents. This document cannot be reproduced or used in any manner whatsoever without the prior written approval of the Company. Any unauthorized alteration, forgery or falsification of the content or appearance of this document is unlawful and offenders may be prosecuted to the fullest extent of the law. Unless otherwise stated the validity shown in this report refers only to the samples tested.

Attention: To check the authenticity of testing SGS-CSTC Reports & certificates, please contact us at telephone: (86-755) 8307 1443 or e-mail: CN.Certification@sgs.com

SGS 集团, 深圳标准技术服务有限公司 地址: 中国深圳 邮编: 518129 电话: (86-755) 25328888 / (86-755) 8307 1443
www.sgs.com.cn
地址: 中国深圳 邮编: 518129 电话: (86-755) 25328888 / (86-755) 8307 1443

Member of the SGS Group (SGS SA)



Test Report No. SZXEC1900530401 Date: 30 Mar 2019 Page 2 of 6

Test Results :

Test Part Description :

Specimen No.	SGS Sample ID	Description
SN1	SZX19-005304.001	Green"PCB"

- Remarks :
- (1) 1 mg/kg = 1 ppm = 0.0001%
 - (2) MDL = Method Detection Limit
 - (3) ND = Not Detected (< MDL)
 - (4) "-" = Not Regulated

RoHS Directive (EU) 2015/863 amending Annex II to Directive 2011/65/EU

Test Method : With reference to IEC 62321-4:2013+A1:2017, IEC62321-5:2013, IEC62321-7-2:2017, IEC 62321-6:2015 and IEC62321-8:2017, analyzed by ICP-OES, UV-Vis and GC-MS.

Test Item(s)	Limit	Unit	MDL	0/1
Cadmium (Cd)	100	mg/kg	2	ND
Lead (Pb)	1,000	mg/kg	2	8
Mercury (Hg)	1,000	mg/kg	2	ND
Hexavalent Chromium (Cr(VI))	1,000	mg/kg	8	ND
Sum of PBBs	1,000	mg/kg	-	ND
Monobromobiphenyl	-	mg/kg	5	ND
Dibromobiphenyl	-	mg/kg	5	ND
Tribromobiphenyl	-	mg/kg	5	ND
Tetrabromobiphenyl	-	mg/kg	5	ND
Pentabromobiphenyl	-	mg/kg	5	ND
Hexabromobiphenyl	-	mg/kg	5	ND
Heptabromobiphenyl	-	mg/kg	5	ND
Octabromobiphenyl	-	mg/kg	5	ND
Nonabromobiphenyl	-	mg/kg	5	ND
Decabromobiphenyl	-	mg/kg	5	ND
Sum of PBDEs	1,000	mg/kg	-	ND
Monobromodiphenyl ether	-	mg/kg	5	ND
Dibromodiphenyl ether	-	mg/kg	5	ND
Tribromodiphenyl ether	-	mg/kg	5	ND
Tetrabromodiphenyl ether	-	mg/kg	5	ND
Pentabromodiphenyl ether	-	mg/kg	5	ND



Unless otherwise agreed in writing, this document is issued by the Company subject to its General Conditions of Service printed on the reverse side of this document or available at <http://www.sgs.com>. The Client's attention is drawn to the limitation of liability, indemnification and jurisdiction issues defined therein. Any holder of this document is advised that information contained herein reflects the Company's findings at the time of its intervention only and within the limits of the Client's instructions. In any event, the Company's sole responsibility is to its Client and this document does not exonerate parties to a transaction from respecting all their rights and obligations under the transaction documents. This document cannot be reproduced or used in any manner whatsoever without the prior written approval of the Company. Any unauthorized alteration, forgery or falsification of the content or appearance of this document is unlawful and offenders may be prosecuted to the fullest extent of the law. Unless otherwise stated the validity shown in this report refers only to the samples tested.

Attention: To check the authenticity of testing SGS-CSTC Reports & certificates, please contact us at telephone: (86-755) 8307 1443 or e-mail: CN.Certification@sgs.com

SGS 集团, 深圳标准技术服务有限公司 地址: 中国深圳 邮编: 518129 电话: (86-755) 25328888 / (86-755) 8307 1443
www.sgs.com.cn
地址: 中国深圳 邮编: 518129 电话: (86-755) 25328888 / (86-755) 8307 1443

Member of the SGS Group (SGS SA)



ZPMV2.E490354 - WIRING, PRINTED - COMPONENT

Wiring, Printed - Component

See General Information for Wiring, Printed - Component

O-LEADING SUPPLY CHAIN (HK) CO LTD
 ROOM 1205, 12/F
 TAI SANG BANK BLDG
 130-132 DES VOEUS ROAD
 CENTRAL, HONG KONG

E490354

Type	Cond Width			SS/ DS/ DSO	Max	Max			Meets UL796	C T	
	Min	Cond	Area		Solder	Flame	Class				
	Min	Edge			Limits			Oper			
mm(in)	mm(in)	Thk	Diam	C	sec	C	DSR	I			
Multilayer (mass laminate) printed wiring boards.											
O-LEADING-401	0.1 (0.004)	0.3 (0.012)	34 (1.34)	DS	12.7 (0.5)	260	10	130	V-0	-	-
O-LEADING-407	0.08 (0.003)	0.2 (0.008)	17 (0.67)	DS	9.7 (0.4)	260	10	130	V-0	All	-
Multilayer printed wiring boards.											
O-LEADING-408	0.125 (0.005)	0.125 (0.005)	12 (0.47) Int:136	DS	50.8 (2.0)	280	20	130	V-0	All	*
Single layer printed wiring boards.											
O-LEADING-002	0.38 (0.015)	1.14 (0.045)	34 (1.34)	SS	19.1 (0.8)	260	10	105	V-0	All	-
O-LEADING-003	0.38 (0.015)	1.14 (0.045)	34 (1.34)	SS	19.1 (0.8)	260	10	130	V-0	▲	-
O-LEADING-033	0.15 (0.006)	0.3 (0.012)	34 (1.34)	SS	25.4 (1.0)	260	10	120	V-0	All	-
O-LEADING-205	0.1 (0.004)	0.3 (0.012)	34 (1.34)	DS	69.6 (2.7)	260	10	130	V-0	All	-
O-LEADING-206	0.15 (0.006)	0.33 (0.013)	17 (0.67)	DS	69.6 (2.7)	260	10	130	V-0	All	-
O-LEADING-D01	0.14 (0.006)	0.15 (0.006)	33 (1.30)	DS	25.4 (1.0)	260	10	130	V-0	All	*
O-LEADING-S01	0.25 (0.010)	0.25 (0.010)	17 (0.67)	SS	25.4 (1.0)	260	4	130	V-0	All	*

WIRING, PRINTED - COMPONENT | UL Product iQ

O-LEADING-S02	0.2 (0.008)	0.2 (0.008)	17 (0.67)	SS	25.4 (1.0)	260	4	130	HB	▲	*
O-LEADING-S03	0.25 (0.010)	0.25 (0.010)	34 (1.34)	SS	25.4 (1.0)	260	4	130	V-0	All	*

* - CTI marking is optional and may be marked on the printed wiring board.

Marking: Company name or file number and type designation. May be followed by a suffix to denote factory identification or burning test classification.

并不是所有出现在本数据库中的公司名称和产品都满足了UL跟踪检验服务的要求。只有带有UL标志的产品，才应该被视为经过UL认证，并满足UL跟踪检验服务的要求。注意查看产品上的标志。

UL 允许在线认证目录中所含材料的复制遵循以下条件：1.指南信息、装配、构造、设计、系统和/或认证（文件）必须在不篡改任何数据（或图纸）的情况下完整且无误导性地呈现。2.经UL允许从在线认证目录转载“声明必须出现在所提取材料的邻近位置。此外，转载材料必须包含以下格式的版权声明：“© 2019 UL LLC”



PCB	
Layer Count	1-32
Weight	1 / 3oz-12oz
Thickness	3.0mil / 3.0mil
Thickness	4.0mil / 4.0mil
Thickness	10mil
Thickness	0.2mm-5.0mm
Size	635 * 1500mm
Thickness	4mil
Plated	+/- 3mil
Blind / Through Hole	Yes
Material	Yes
Material	FR-4 FR-4high Tg
Surface Finish	HASL OSP ENIG HAL-LF Immersion

SMT

PCB	FR-4 CEM-1 CEM-3 FPC
PCB Size	510x1500mm
PCB Size	50x50mm
PCB Thickness	0.5mm-4.5mm
Drill Size	0.5-4mm
Drill Size	0201
Drill Size	0603
Drill Size	15mm
Drill Size	0.3mm
BGA	0.4mm
Drill Size	+/- 0.03mm



Shipping service



Quick Turn Lead Time		
Layer Count:	Lead Tim	Special Requirement
1L/2L	2-3days	24 Hours,48 Hours
4L	3-4days	48 Hours
6L	4-5days	72 Hours
8L	5-6days	NA
10L	6-7days	NA
12L	7-8days	NA
14L	8-9days	NA

Standard Lead Time		
Layer Count:	Sample Lead Time	Volume order lead time
2L	4 days	10 days
4L	5 days	11 days
6L	6 days	12 days
8L	8 days	14 days
10L	10 days	16 days
12L	12 days	18 days
14L	14 days	20 days
16-32L	18 days	24 days



1. O-Leading

- 1.1 ISO 9001:2008
- 1.2
- 1.3 X-ray AOI ICT
- 1.4
- 1.5

2. O-Leading

10 2 3 4 31 O-Leading

3. O-Leading

FR4 TG Rogers Arlon Telfon PI

4. PCB PCBA

- 4.1 BOM
- 4.2 PCB
- 4.3 PCB PCBA
- 4.4
- 4.5

5. PCB
→ → → AOI → → → PTH → → → → → AOI → → → → E / T →

6. HDI
VCP LDI
LDI

7. O-lead
O- ENIG OSP LF-HASL / HDI
OSP ENIG OSP + ENIG BGAPAD 0.3mm OSP OSP + ENIG

8. FPC O-Leading SMT
O-Leading 8 FPC 2000mm * 240mm
SMT

- 9. PCB
- ;
- ;
- ;
- ;
- PCB;
- ;
- ;

10. PCB PWB FPC
PCB
PWB
FPC Flexible Printed Board

11. PCB
PCB
Tg
CTE
PCB 50 250°C
PCB / PCB

12. O-leading rigid-flex PCB
O-leading PCB FPC PCB

13.
SI6000 POLAR INSTRUMENTS CITS500s