

O-leading

O-Leading PCB PCB PCB PCB EMS PCBA SMD PCB HDI PCB PCB PCB PCB

O

O-leading PCB PCBA

FR4 PCB



O-LEADING **TRAINING**



Keep **LEARNING**

There's a phrase in Buddhism, 'Beginner's mind.'

It's wonderful to have a beginner's mind

WE HAVE A **DREAM**

Keep **RUNNING**

I would like to live to study and not study to live.

---Bacon

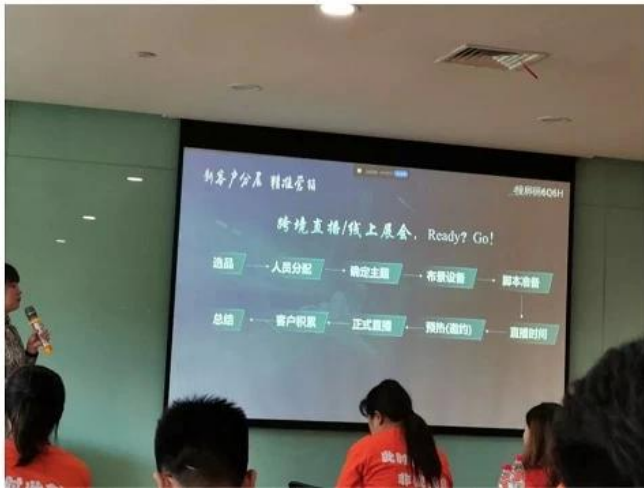

PCB Pcb SMT PCBA

PCB	PCB
PCB	PCB+PCBA
PCB	OEM
PCB	ROSH ISO9001
PCB	PCB
PCB	FR4 / PCB/PCBA CEM1
PCB	PCB
PCB	PCB

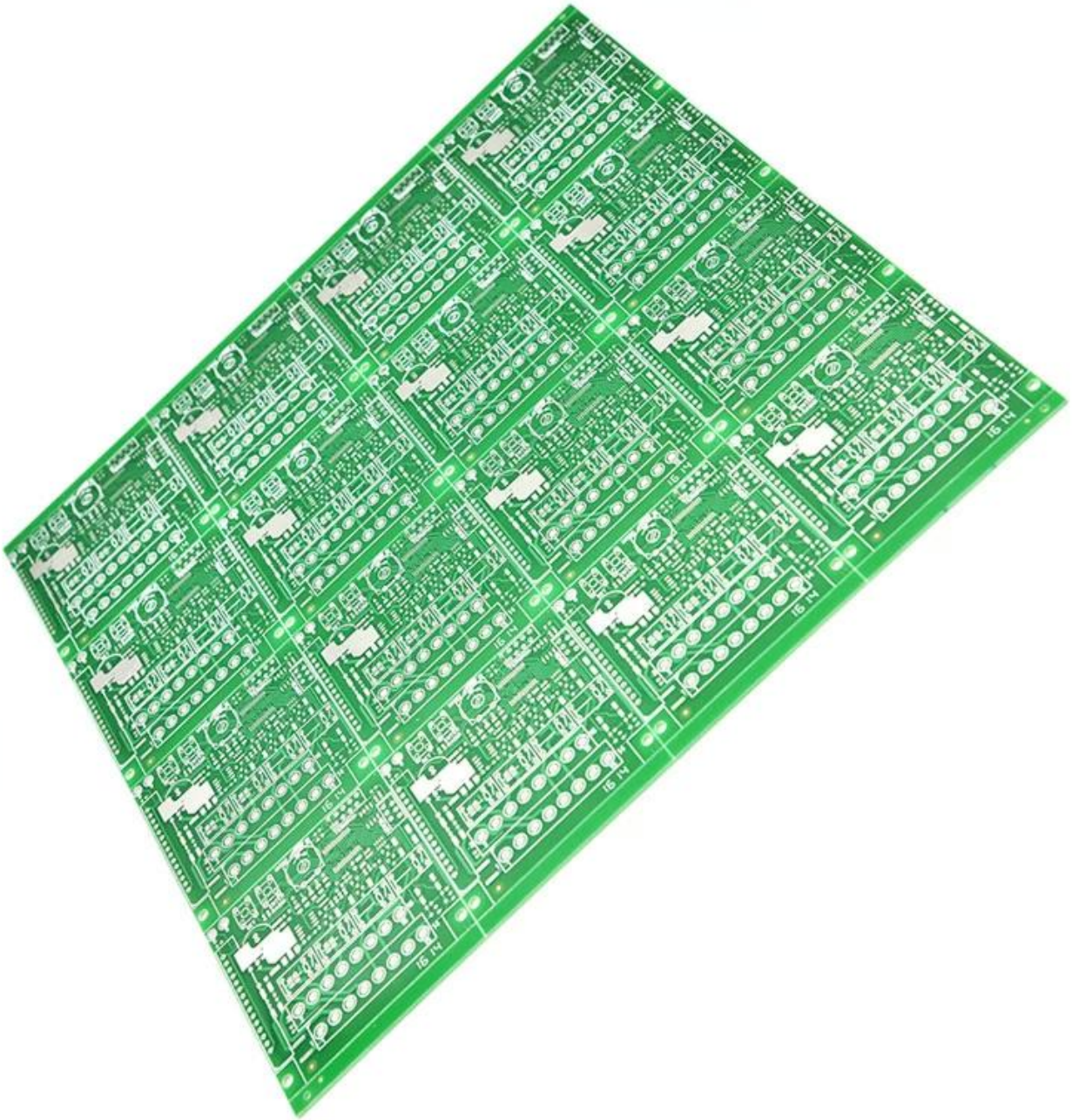

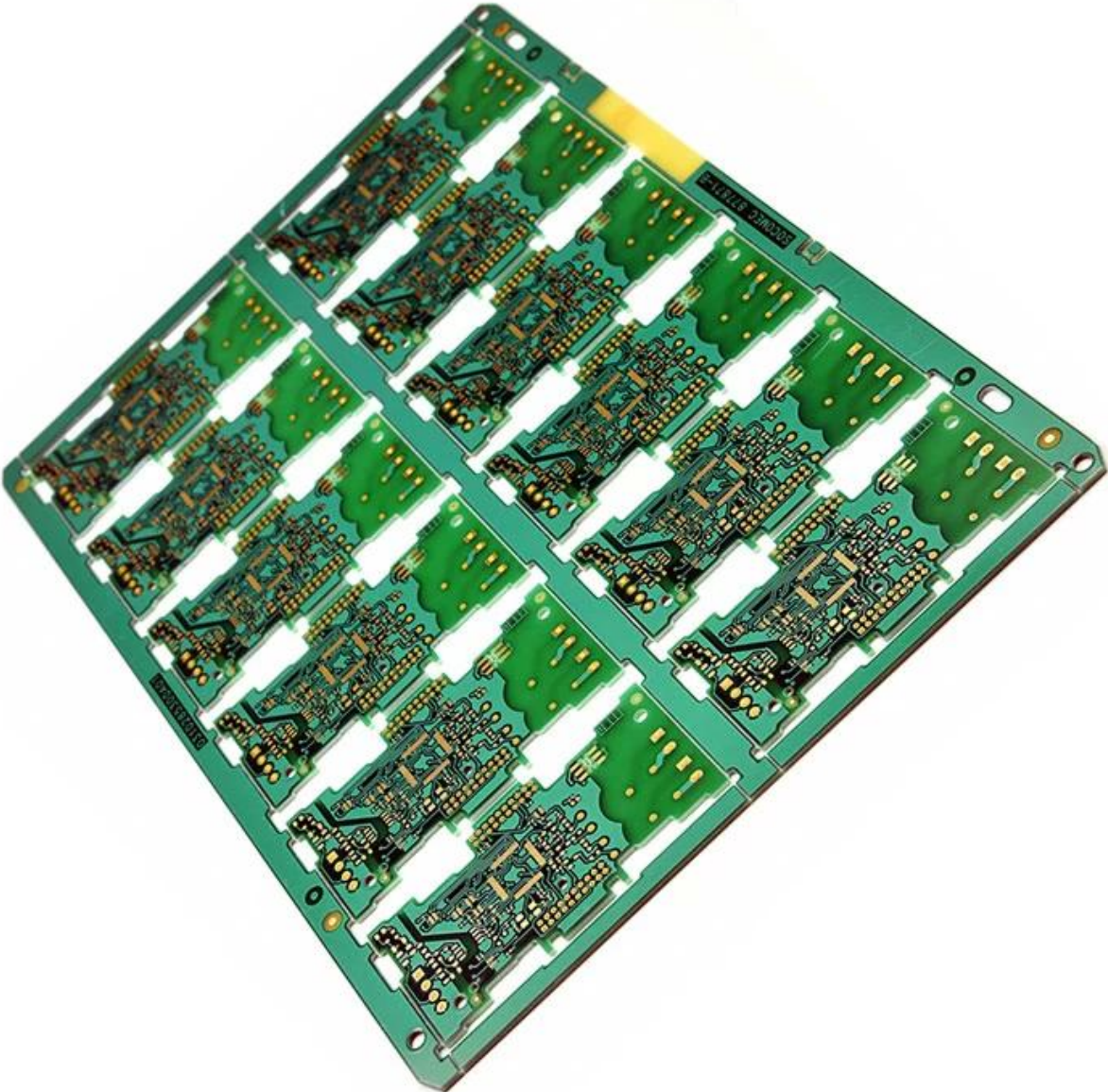

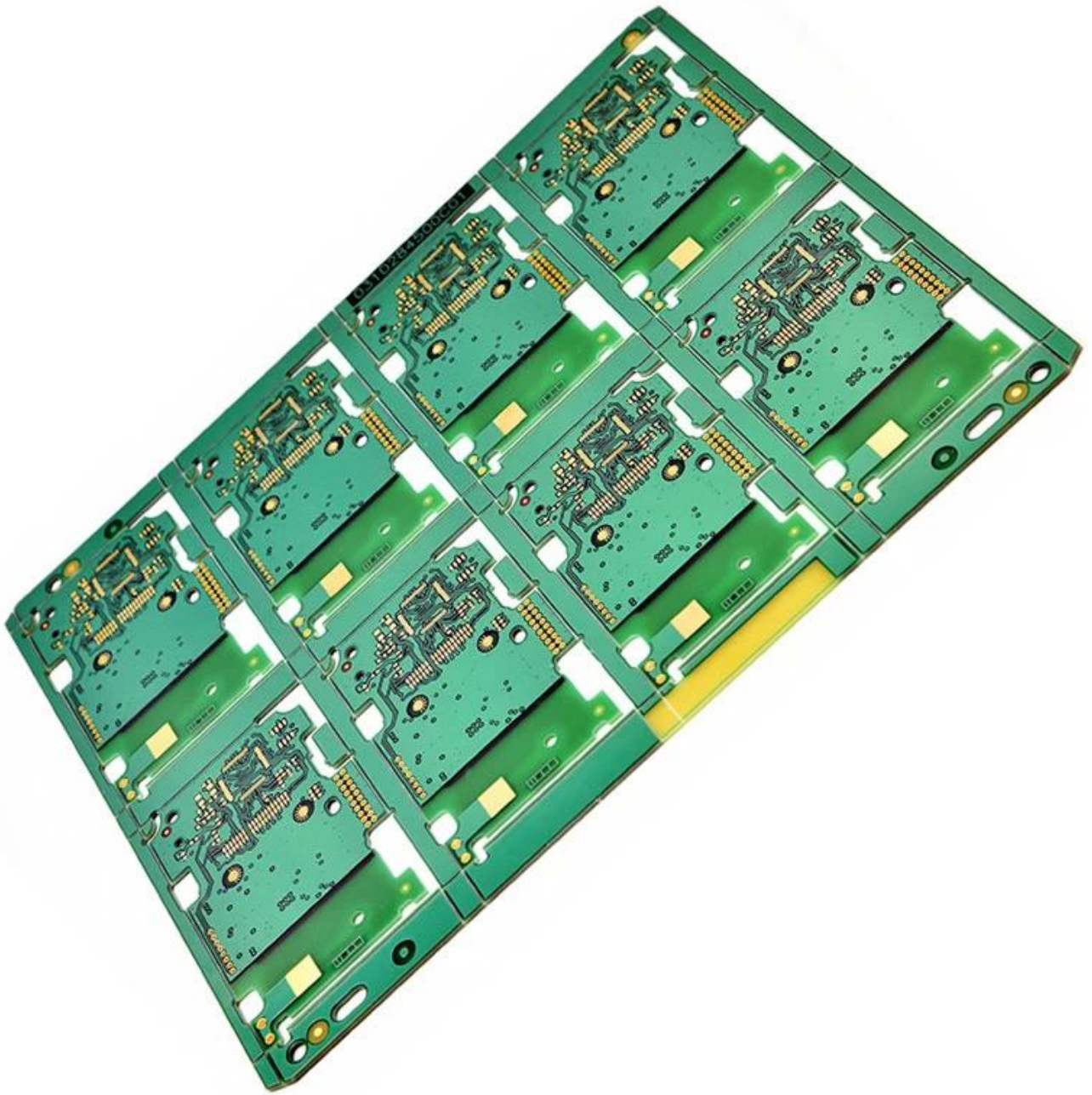

TOP QUALITY PCBA

O-LEADING

To Be Reliable, To Be Valuable

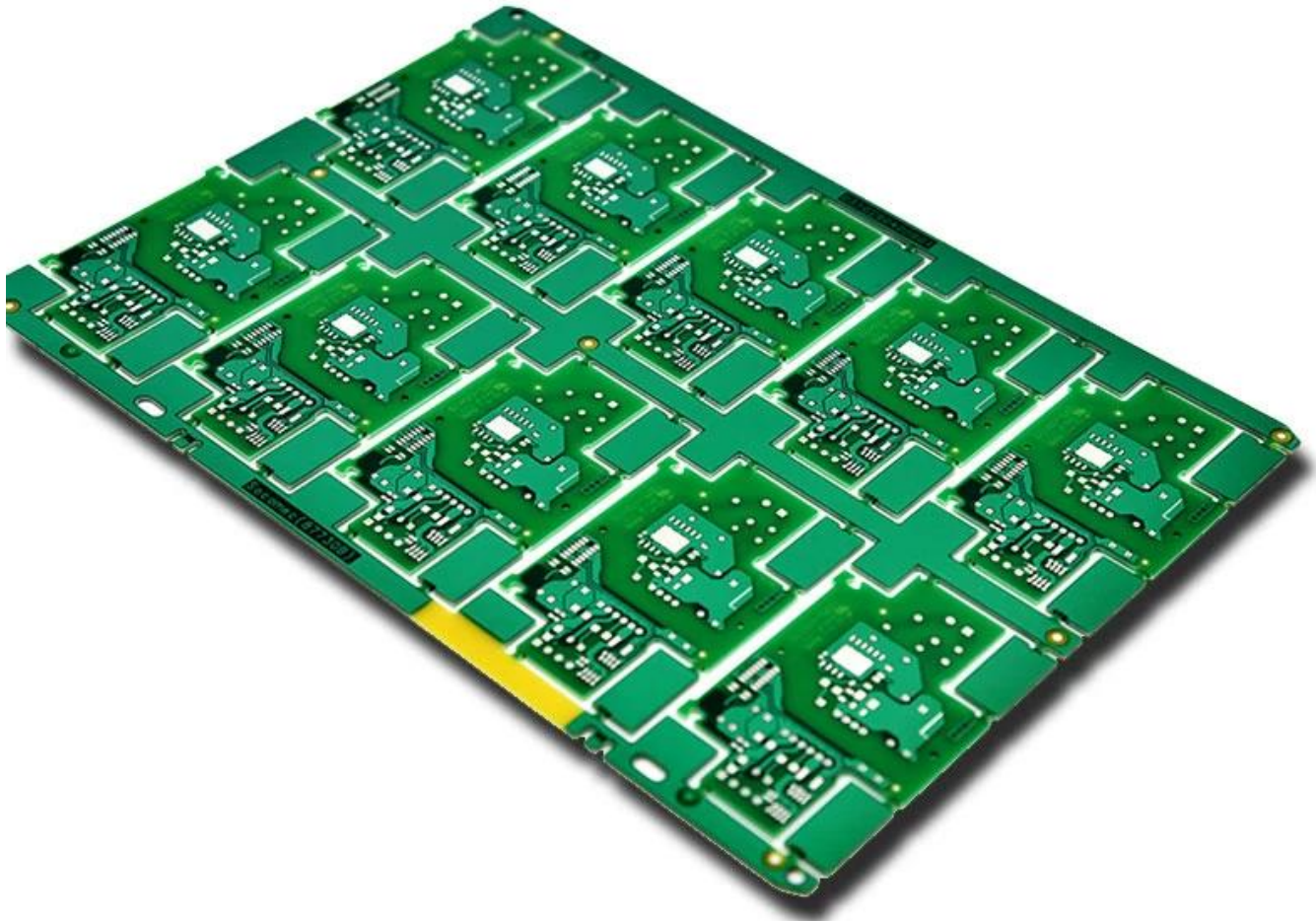

MAKE YOUR IDEA COME **TRUE**

TOP QUALITY PCBA

O-LEADING

To Be **Reliable**, To Be **Valuable**

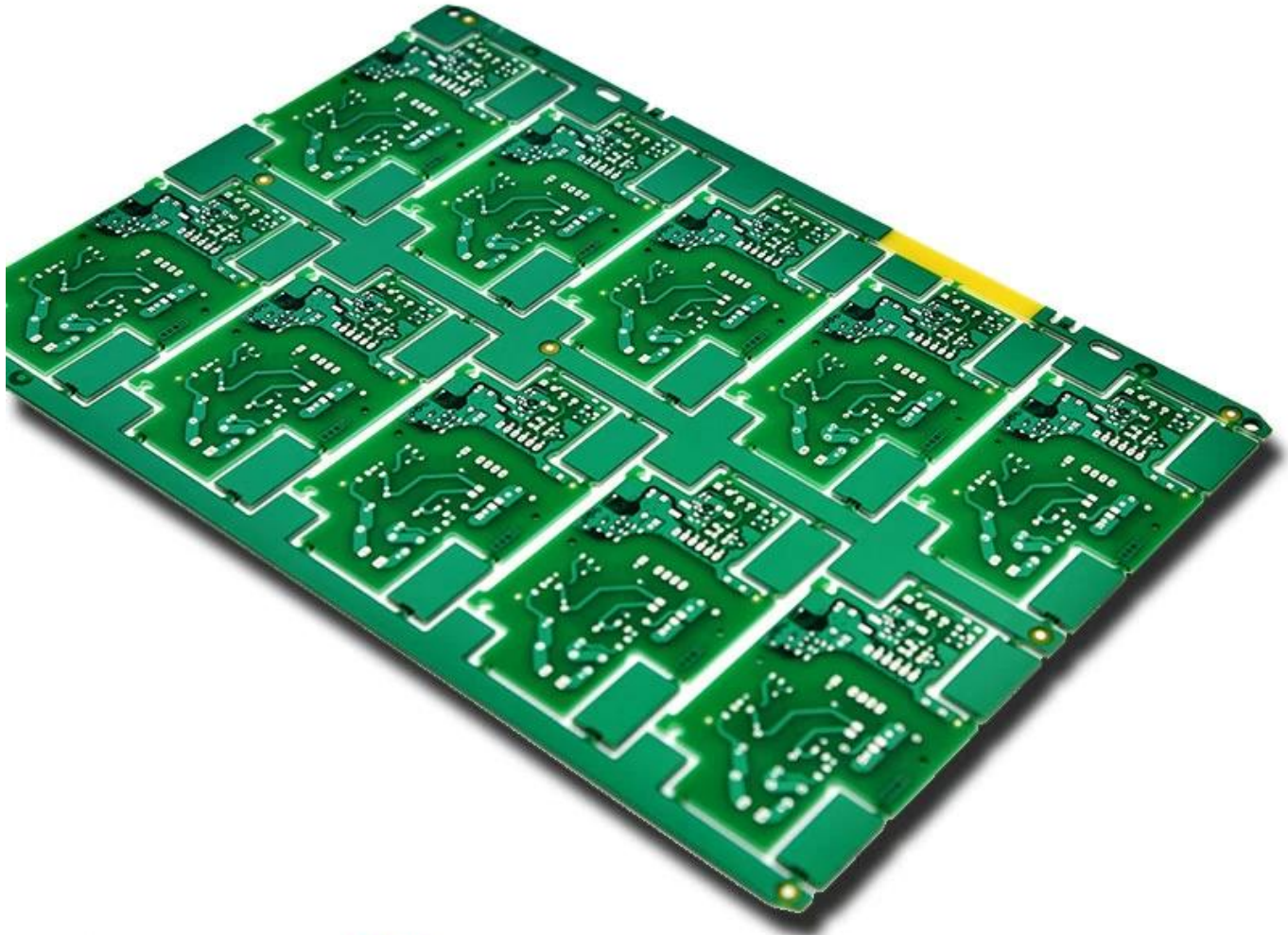

MAKE YOUR IDEA COME **TRUE**

TOP QUALITY PCBA

O-LEADING

To Be Reliable, To Be Valuable

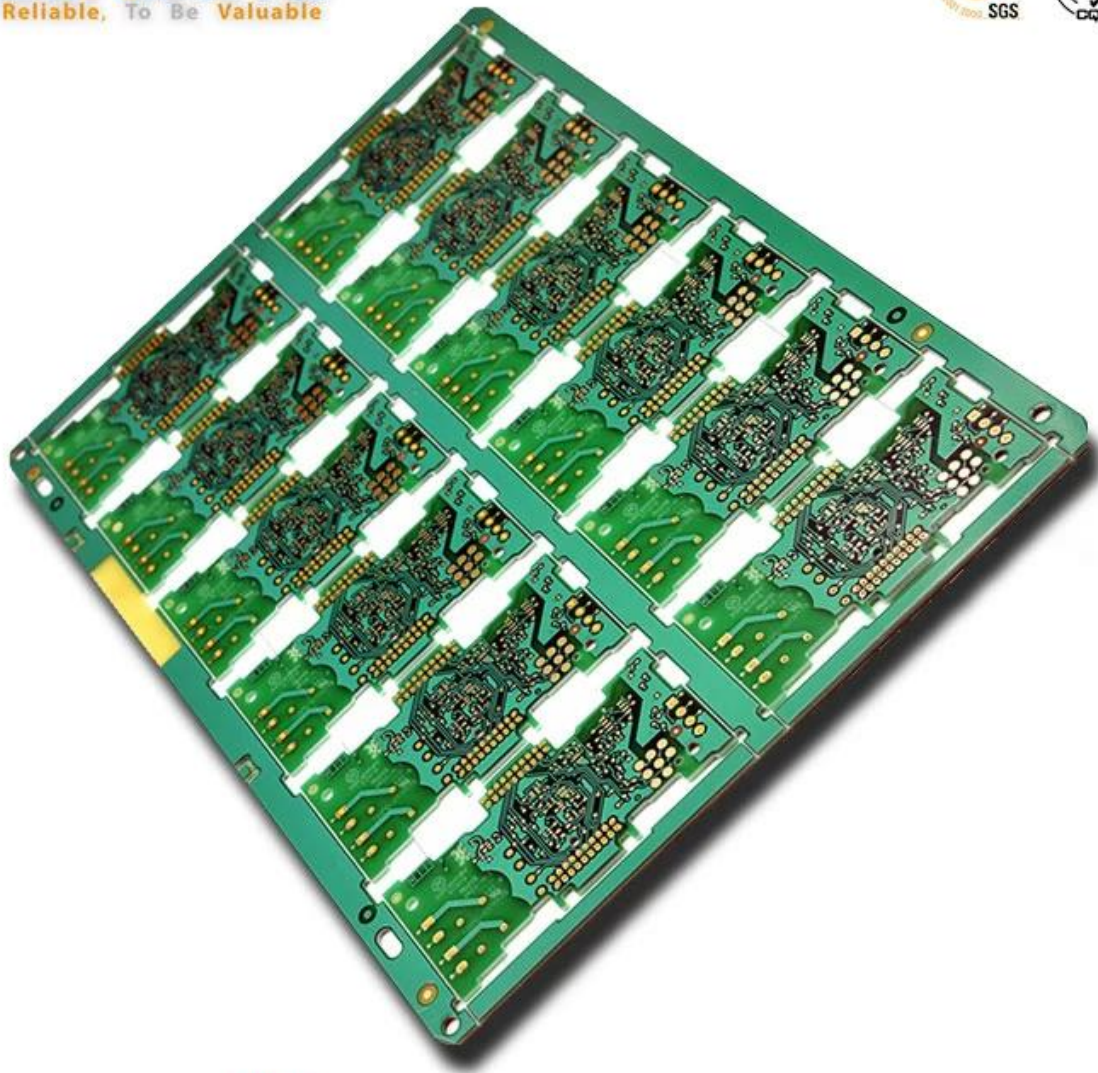

MAKE YOUR IDEA COME **TRUE**

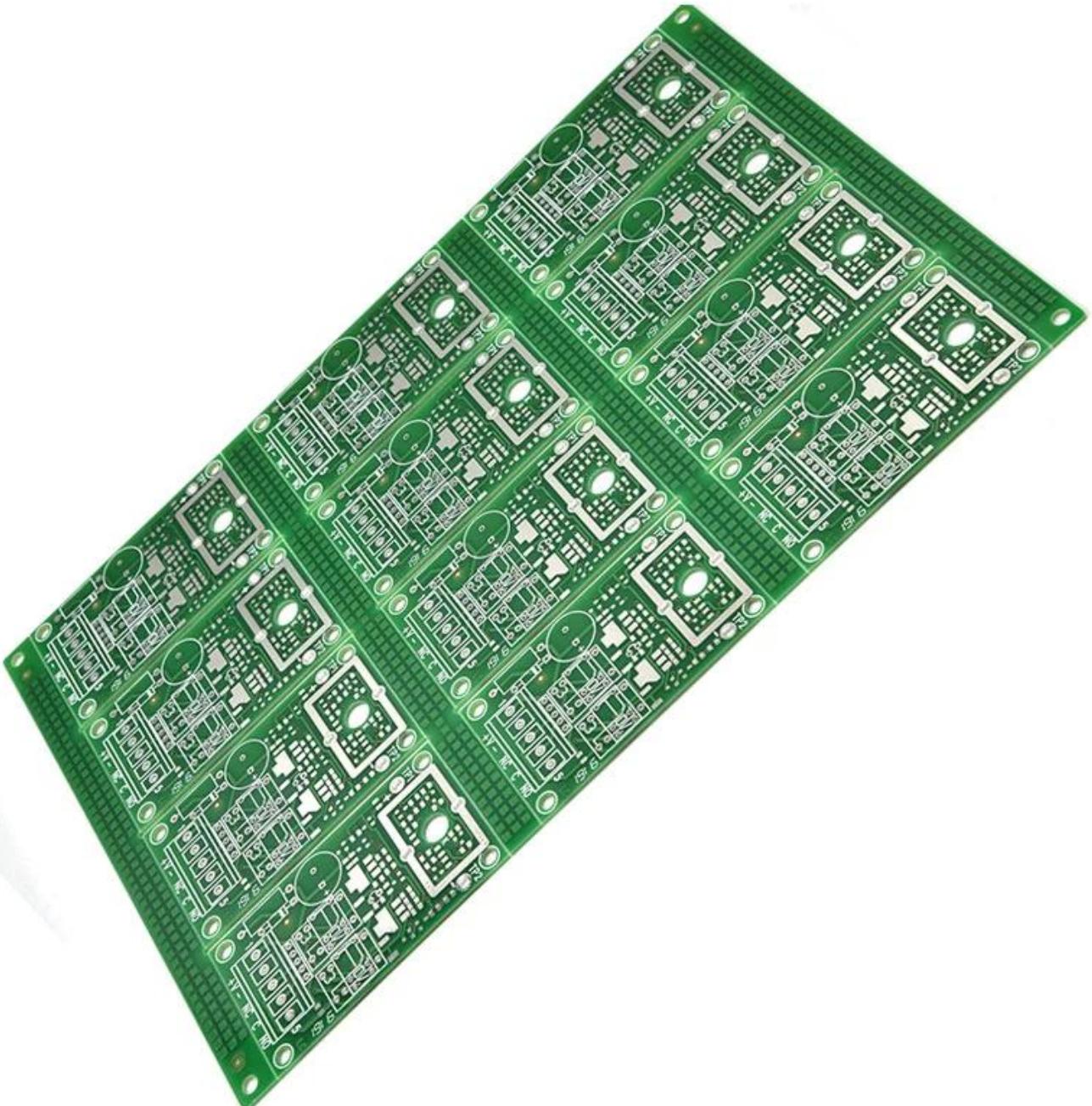

Market Share

 CONSUMER ELECTRONICS

 AUTOMOTIVE ELECTRONICS

 INDUSTRIAL CONTROL

 INTELLECTUALIZED HOUSEHOLD CONTROL

 OTHER



30%
CONSUMER ELECTRONICS



18%
INTELLECTUALIZED HOUSEHOLD CONTROL

20%
AUTOMOTIVE ELECTRONICS



12%
OTHER

20%
INDUSTRIAL CONTROL



Product types

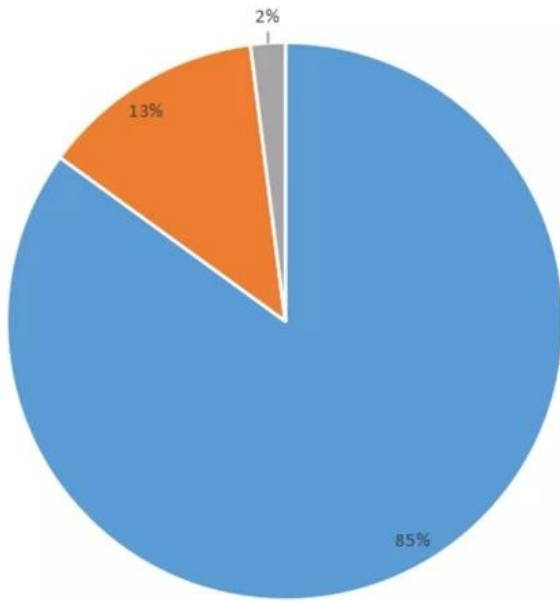

■ FR-4 PCB ■ MC PCB ■ rigid-flexible PCB

Product layers

■ 1L ■ 2L ■ 4L ■ 6L ■ >8L

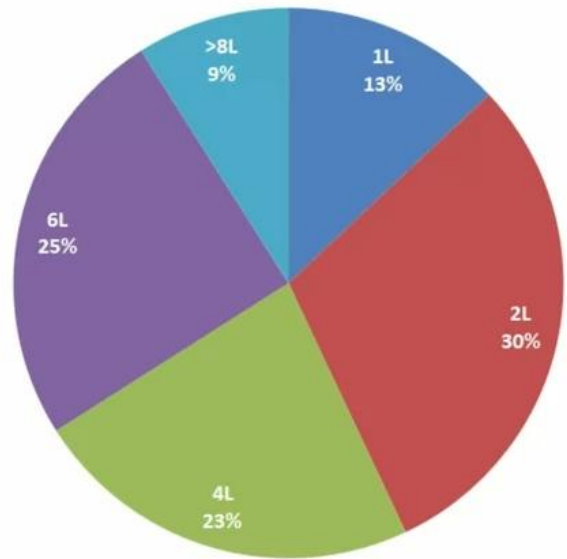

Production Process

18 years experience in one-stop PCB and PCBA, we can make your idea come true,





Factory PCB



Automatic vacuum press machine



Drilling Machine



Pattern Plating Machine



Scrubbing Machine



Developing Machine



Routing Machine



High-speed flying probe machine



E-test Machine

Factory SMT



HOW O-LEADING MAKE A PROJECT FOR YOU

Hardware Dispenser Application Not



Automatic Dispenser Application Not

Voltage Table

Volt Pin Number	Description
VDD	Battery Voltage
+3V3	+3.3V
+5V	+5V
USB +5V	USB 5V input
+5V/2	Isolated +5V
+12V	12V DC Drive

STM32F072 PinOUT table

Wire Name	Description	DIO	Mode	Note
SMTN_TOF	Shutdown Time of flight sensor	Output	Logic '1' to shutdown	
I2C_SCL_TOF	I2C communication with time of flight sensor	I2C1_SCL		
I2C_SDA_TOF	I2C communication with thermopile sensor	I2C1_SDA		
I2C_SCL_IR	I2C communication with load cell control pins	I2C2_SCL		
I2C_SDA_IR		I2C2_SDA		
RATE_IC		Output		
DOUT_IC		Output		

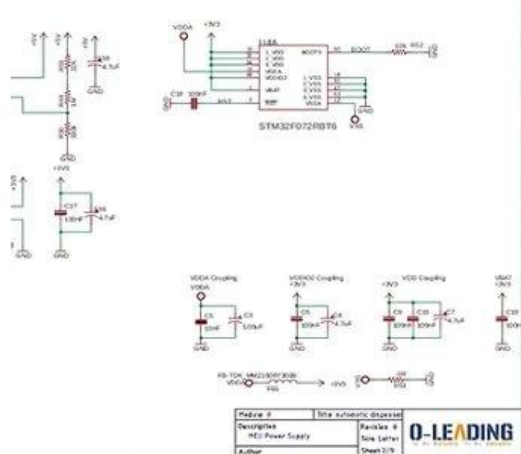

HARDWARE schematics

PCB PRODUCTION COMPONENTS SOURCING

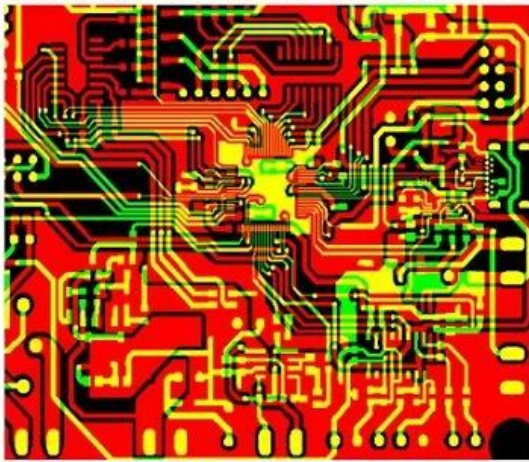

Qty	Value	Device	Parts	Description
4	AK500/1	AK500/2	X1, X2	CONNECTOR
1	AK500/3	AK500/3	X7	CONNECTOR
1	124114	MA04-2	SV2	
1	PPPC04	MA04-2	SV1	8 POS, 4*2 FEMALE PIN HEADE
1	ML10	ML10	SV4	HARTING
1	8MHZ	XTALL_CSTCE8M	X5	STCE8M00G52-R0 RESONATOR
1	0R	R-0603	R53	Thick Film Resistors - SMD 0603
2	10R	R-0603	R12, R5	Thick Film Resistors - SMD 0603
8	100R	R-0603	R1, R2	Thick Film Resistors - SMD 0603
1	270R	R-0805	R15	Thick Film Resistors - SMD 0605
1	330R	R-0603	R11	Thick Film Resistors - SMD 0603
9	680R	R-0603	R20, R3	Thick Film Resistors - SMD 0603
17	1k	R-0603	R9, R10	Thick Film Resistors - SMD 0603
2	4.7k	R-0603	R17, R6	Thick Film Resistors - SMD 0603
2	5.1k	R-0603	R18, R7	Thick Film Resistors - SMD 0603
9	10k	R-0603	R16, R3	Thick Film Resistors - SMD 0603

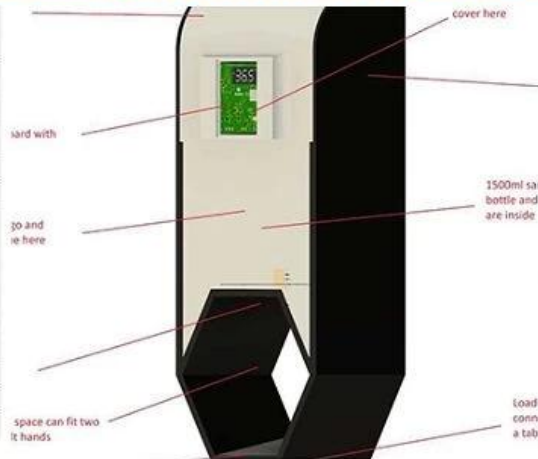

PCB Assembly MECHANICAL DESIGN

O-LEADING CUSTOMER

To be **RELIABLE**

- Q**uality first ,
- C**ustomer supreme ,
- S**cientifically management ,
- S**triving for famous brand



THE CUSTOMER IS KING

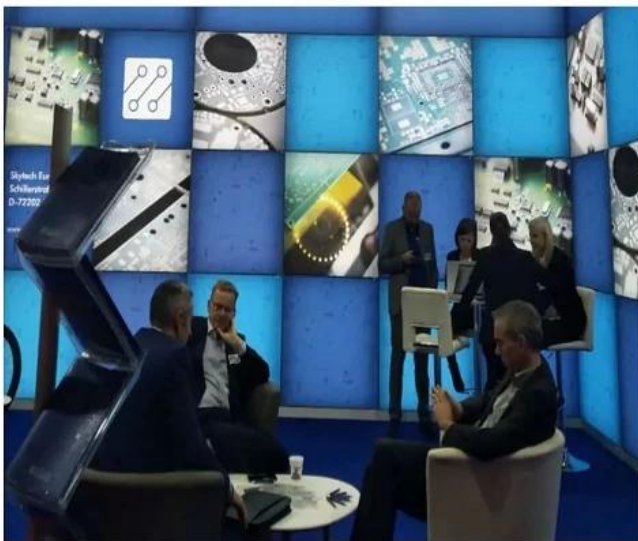

To be **VALUABLE**

- S**cience and technology keeps head ,
- P**ut people first ,
- B**e precise and practical ,
- C**ontribute sincerely

Skyworth 创维

HET 和而泰
HET INTELLIGENT CONTROL

dongweikeji
东威科技

美的 Midea

STAR-NET
星网锐捷

FORYOU
ADAYO 华阳集团

EDIFIER[®]

Cultraview 金锐显

3nod 三诺

T&W

TCL

AcBel 康舒科技
ACBEL POLYTECH INC.

Honeywell

Schneider
Electric

ZTE 中兴

EMERSON

BYD

PHILIPS

TE
connectivity

VIDEOTON

O-LEADING **CUSTOMER REVIEW**

CUSTOMER VOICE IS **EXTREMELY IMPORTANT TO US**

订单编号: 49335463501024670

供应商服务: 非常满意 (5 stars) 按时发货: 非常满意 (5 stars)



High quality usb power pcb , pcba manufacturer

★★★★★

Fancy has done an excellent job, whenever we write, she answered us within 1 second, O-leading is very perfect with fast delivery, fast logistics, the most important thing is good quality, good packaging, thank you!

[回复该评论](#)



oem customized rohs pcb drawing schematic s...

★★★★★

We received the boards, the quality is very good, the price is very reasonable, Fancy is very nice & smart & experienced, the logistics is super fast, I will come to see more in the future.

[回复该评论](#)

订单编号: 490224962001024670

供应商服务: 非常满意 (5 stars) 按时发货: 非常满意 (5 stars)



High TG180 FR-4 Circuit HDI PCB 94V0 Board...

★★★★★

This is a very efficient PCB design, but we are lucky to find O-leading to support the PCB for us, very good to a PCB supplier.



universal FR4 Multilayer PCB washing machine...

★★★★★

Fancy gives us very excellent service, very professional and experienced, O-leading is the best one of our suppliers, very happy to work with them.

订单编号: 49298271001024670

供应商服务: 非常满意 (5 stars) 按时发货: 非常满意 (5 stars)



High TG180 FR-4 Circuit HDI PCB 94V0 Board ...

★★★★★

perfect product, perfect PCB supplier!

[回复该评论](#)



oem customized rohs pcb drawing schematic s...

★★★★★

Very good and professional PCB product as usual!

[回复该评论](#)



Strip LED Aluminum FR-4 lighting PCB board 9...

★★★★★

High quality, fast delivery, good service, competitive price, lucky and happy to purchase from O-leading!

[回复该评论](#)

订单编号: 4093862201024670

供应商服务: 非常满意 (5 stars) 按时发货: 非常满意 (5 stars)



High quality Keyboard pcb & pcba Factory SMT...

★★★★★

Top quality, it's the right choice to choose O-leading to make the PCB & PCBA

[回复该评论](#)



Professional Printed Circuit Board Manufact...

★★★★★

Very high quality PCB products, O-leading is the best PCB supplier that we have ever worked with.

订单编号: 44068794501024670

供应商服务: 非常满意 (5 stars) 按时发货: 非常满意 (5 stars)



High TG180 FR-4 Circuit HDI PCB 94V0 Board ...

★★★★★

We bought two batches, one by DHL, the other one by air, good quality and fast delivery!

LISTEN TO CUSTOMER VOICE

订单编号: 40903347501024670

供应商服务: 非常满意 (5 stars) 按时发货: 非常满意 (5 stars)



Strip LED Aluminum FR-4 lighting PCB board 9...

★★★★★

Very fast delivery! Fantastic, good job!!!



Professional Printed Circuit Board Manufact...

★★★★★

Very happy to great support from O-leading, they are not only professional on the PCB, but also provide good PCB products, very good supplier!

订单编号: 36919647001024670

供应商服务: 非常满意 (5 stars) 按时发货: 非常满意 (5 stars)



AML-S802 Quad-core Android embedded boar...

★★★★★

Good products



Fast delivery low cost pcb fabrication O-leadin...

★★★★★

Good supplier

订单编号: 37378603001024670

供应商服务: 非常满意 (5 stars) 按时发货: 非常满意 (5 stars)



hot sale rigid-flexible PCB with 0.2mm BGA an...

★★★★★

very professional supplier



High Quality custom FPCB/Flex PCB/FPC/Flexi...

★★★★★

Good product



OEM ODM PCBA Bluetooth Wireless Marking G...

★★★★★

high soldering quality



Electronic parts haptic pcba Circuit Board asse...

★★★★★

Very Good product

订单编号: 36919647001024670

供应商服务: 非常满意 (5 stars) 按时发货: 非常满意 (5 stars)



Lidar IR Sensor board pcba(H08R6x)

★★★★★

perfect product



Customized PCBA design PCB design

★★★★★

perfect



Audio Speaker and Headphone Jack (H07R3x)

★★★★★

High quality, good

订单编号: 37378603001024670

供应商服务: 非常满意 (5 stars) 按时发货: 非常满意 (5 stars)



Raspberry pi 0 Zero Raspberry Pi Zero P1 W ver...

★★★★★

Fantastic products!!





double layer pcb with red S/M and LF-HASL su...

★★★★★

Good!

订单编号: 36919647001024670

供应商服务: 非常满意 (5 stars) 按时发货: 非常满意 (5 stars)



half hole pcb, half hole pcb module, half hole m...

★★★★★

Top half hole pcb supplier, very perfect goods



High Quality custom FPCB/Flex PCB/FPC/Flexi...

★★★★★

this rigid-flexible pcb quality is perfect!



Electronic parts haptic pcba Circuit Board asse...

★★★★★

Very satisfied with O-leading products and quality, especially their on-time delivery, fantastic!

Be kind to your client, because he has many choices, but he chooses you instead.



CICC INSPECTION CERTIFICATION



嘉泰认证

QUALITY MANAGEMENT SYSTEM CERTIFICATE

Certificate No: 18118Q10347R05

We hereby certify that

O-LEADING SUPPLY CHAIN(HK) CO.,LIMITED

Credit No: 61691591-000-07-18-7

Registration Add: FLAT/RM 1205 12/F TAI SANG BANK BUILDING 130-132 DES
VOEUS BOAD CENTRAL HK

Business Add: 1313, Floor 13, Fortune Building, Danshui Town, Huiyang
District, Huizhou, Guangdong, China

Has implemented and maintains a **Quality Management System**
Which fulfils the requirements of the following standards
GB/T19001-2016 idt ISO9001:2015

Scope of certification

Sales of printed circuit boards

Initial issuance period: February 27, 2018
Renewal date: April 22, 2019

This certificate is valid during: April 22, 2019 ~ February 26, 2021

This certificate is invalid without CICC qualified label in the following period

First supervision and audit	Second supervision and audit	Qualified mark
-----------------------------	------------------------------	----------------

The certification implementation scope does not include those production stages which shall be assumed by the relevant effective administrative provisions and qualification provisions regulated by the state.
The effectiveness of this certificate shall be notified by annual surveillance audits of CICC. The certificate shall be valid also only together with the surveillance audit certificate.
The initial information of this certificate can be searched at the portal of CICC: www.cicc.com.cn or by the code of inquiry: www.cicc.com.cn





CICC INSPECTION CERTIFICATION



嘉泰认证

质量管理体系认证证书

证书号: 18118Q10347R05

兹证明

诚领供应链(香港)有限公司

统一社会信用代码: 61691591-000-07-18-7

注册地址: 香港中環德輔道中 130-132 號大生銀行大廈 1205 室

经营地址: 广东惠州惠阳淡水南亨西路财富大厦 13 楼 1313

建立的质量管理体系符合

GB/T19001-2016 idt ISO9001:2015 质量标准适用条款的要求

认证范围

印刷线路板的销售

初次发证日期: 2018年02月27日

换证日期: 2019年04月22日

证书有效期: 自2019年04月22日至2021年02月26日

在下列期限内, 未经 CICC 黏贴合格标贴, 本证书无效

第一次监审	第二次监审	粘标处
-------	-------	-----

本证书认证范围不包括未获得有效的国家规定的行政许可、资质许可的产品/服务范围。
本证书通过CICC定期监督审核保持, 与年度《保持认证通知书》共同方为有效。
本证书信息可在国家认监委网站: www.cnca.gov.cn及CICC网站www.cicc.com.cn查询。







ZPMV2.E490354 - WIRING, PRINTED - COMPONENT

Wiring, Printed - Component

See General Information for Wiring, Printed - Component

O-LEADING SUPPLY CHAIN (HK) CO LTD

E490354

ROOM 1205, 12/F
TAI SANG BANK BLDG
130-132 DES VOEUS ROAD
CENTRAL, HONG KONG

Type	Cond Width		Cond Thk mic(mil)	SS/ DS/ DSO	Max	Max		Meets UL796	C		
	Min	Edge			Area Diam	Solder Limits	Oper Temp			Flame	
	mm(in)	mm(in)			mm(in)	C	sec	C	Class	DSR	I
Multilayer (mass laminate) printed wiring boards.											
O-LEADING-401	0.1 (0.004)	0.3 (0.012)	34 (1.34)	DS	12.7 (0.5)	260	10	130	V-0	-	-
O-LEADING-407	0.08 (0.003)	0.2 (0.008)	17 (0.67)	DS	9.7 (0.4)	260	10	130	V-0	All	-
Multilayer printed wiring boards.											
O-LEADING-408	0.125 (0.005)	0.125 (0.005)	12 (0.47) Int:136	DS	50.8 (2.0)	280	20	130	V-0	All	*
Single layer printed wiring boards.											
O-LEADING-002	0.38 (0.015)	1.14 (0.045)	34 (1.34)	SS	19.1 (0.8)	260	10	105	V-0	All	-
O-LEADING-003	0.38 (0.015)	1.14 (0.045)	34 (1.34)	SS	19.1 (0.8)	260	10	130	V-0	▲	-
O-LEADING-033	0.15 (0.006)	0.3 (0.012)	34 (1.34)	SS	25.4 (1.0)	260	10	120	V-0	All	-
O-LEADING-205	0.1 (0.004)	0.3 (0.012)	34 (1.34)	DS	69.6 (2.7)	260	10	130	V-0	All	-
O-LEADING-206	0.15 (0.006)	0.33 (0.013)	17 (0.67)	DS	69.6 (2.7)	260	10	130	V-0	All	-
O-LEADING-D01	0.14 (0.006)	0.15 (0.006)	33 (1.30)	DS	25.4 (1.0)	260	10	130	V-0	All	*
O-LEADING-S01	0.25 (0.010)	0.25 (0.010)	17 (0.67)	SS	25.4 (1.0)	260	4	130	V-0	All	*

WIRING, PRINTED - COMPONENT | UL Product iQ

O-LEADING-S02	0.2 (0.008)	0.2 (0.008)	17 (0.67)	SS	25.4 (1.0)	260	4	130	HB	▲	*
O-LEADING-S03	0.25 (0.010)	0.25 (0.010)	34 (1.34)	SS	25.4 (1.0)	260	4	130	V-0	All	*

* - CTI marking is optional and may be marked on the printed wiring board.

Marking: Company name or file number and type designation. May be followed by a suffix to denote factory identification or burning test classification.

并不是所有出现在本数据库中的公司名称和产品都满足了UL跟踪检验服务的要求。只有带有UL标志的产品，才应该被视为经过UL认证，并满足UL跟踪检验服务的要求。注意查看产品上的标志。

UL 允许在线认证目录中所含材料的复制遵循以下条件：1.指南信息、装配、构造、设计、系统和/或认证（文件）必须在不篡改任何数据（或图纸）的情况下完整且无误导性地呈现。2.经UL允许从在线认证目录转载“声明必须出现在所提取材料的邻近位置。此外，转载材料必须包含以下格式的版权声明：“© 2019 UL LLC”



PCB	
Quantity	10000-32000
Quantity/lot	1 / 3oz-12oz
Thickness	3.0mil / 3.0mil
Thickness	4.0mil / 4.0mil
Thickness	10mil
Thickness	0.2mm-5.0mm
Size	635 * 1500mm
Thickness	4mil
Plated	+/- 3mil
Blind / Through Hole	Yes
Through Hole	Yes
Material	FR-4 / FR-4high Tg
Surface Finish	HASL / OSP / ENIG / HAL-LF

SMT

PCB	FR-4 / CEM-1 / CEM-3 / FPC
PCB Size	510x1500mm
PCB Size	50x50mm
PCB Thickness	0.5mm-4.5mm
Thickness	0.5-4mm
Thickness	0201
Thickness	0603
Thickness	15mm
Thickness	0.3mm
BGA	0.4mm
Thickness	+/- 0.03mm



Shipping service



- 4.1 BOM
- 4.2 PCB
- 4.3 PCB PCBA
- 4.4
- 4.5

5. PCB

→ → AOI → PTH → → E / T →

6. HDI

VCP LDI LDI

7. O-lead

O- ENIG OSP LF-HASL / HDI
OSP ENIG OSP + ENIG BGAPAD 0.3mm OSP OSP + ENIG

8. FPC O-Leading SMT

O-Leading 8 FPC 2000mm * 240mm SMT

9. PCB

- ;
- ;
- ;
- ;
- PCB;
- ;
- ;

10. PCB PWB FPC

PCB
PWB
FPC Flexible Printed Board

11. PCB

PCB
Tg
CTE
PCB 50 250°C
PCB /
PCB
;

12. O-leading rigid-flex PCB

O-leading PCB FPC PCB

13.

SI6000 POLAR INSTRUMENTS CITS500s