

# O-LEADING

PCB, PCB, PCB, EMS, 1, HDI PCB, PCB, PCB, WE, PCB, Quick Turn Prototype

O-LEADING, PCB, PCBA

[pRaspberry Pi 4 Abs](#) [rofessional](#) [PCB](#)

**O-LEADING**  
To Be Reliable, To Be Valuable

WE ALWAYS PROVIDE YOU

**BEST HIGH DENSITY INTERCONNECT PCB**

WE ALWAYS PROVIDE YOU

**BEST RIGID-FLEXIBLE CIRCUIT**

□□□□

Alphabot2, PI4B-4GB, PI 4



\* The Raspberry Pi 4 is optional, up to your choice.

# Raspberry Pi 4 Completely Upgraded

More Powerful Processor, Richer Multi-Media Capability, Faster Networking

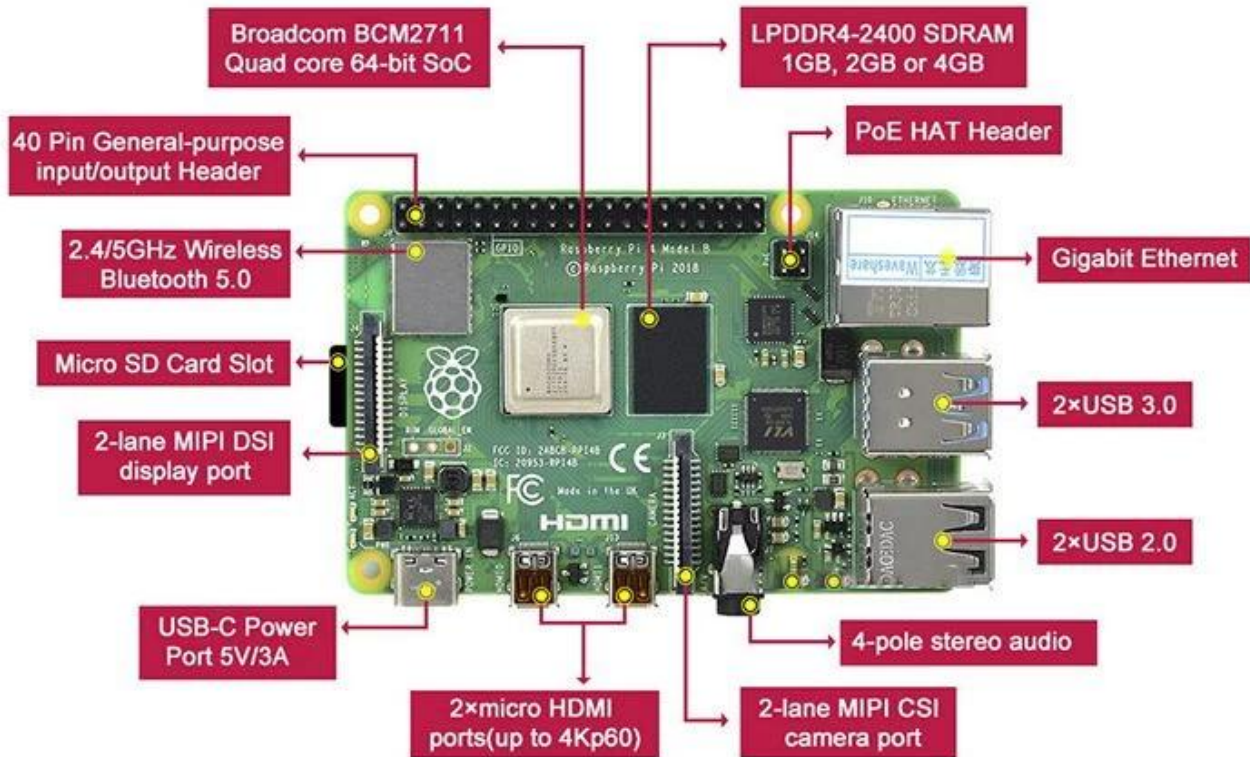

## BCM2711B0

64-bit 1.5GHz Quad-core Processor

## Choice Of RAM

2GB / 4GB / 8GB

## 4K Dual HDMI

4K High Resolution Dual Displays

## Faster Networking

Gigabit ETH, Bluetooth 5.0, Dual-band WiFi

## New USB3.0

2xUSB3.0 + 2xUSB2.0

## USB-C Power

Upgraded Power Supply, More Powerful



# Versatile AlphaBot2 Chassis

Compatible With Multi Controllers Via Related Adapter Boards (Purchased Separately)

Easily Turn It Into A Pi Zero / Arduino Robot

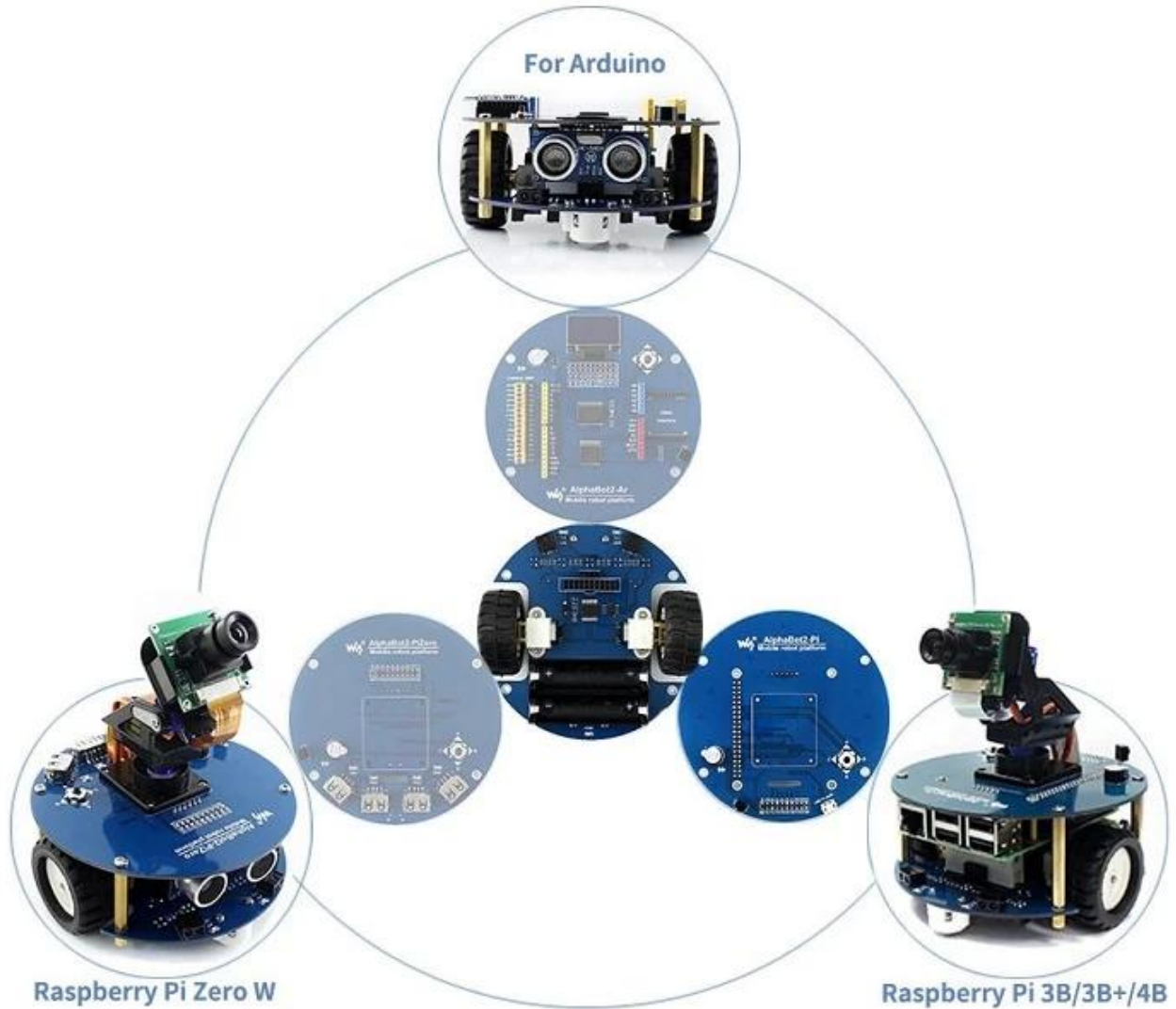

# Modular Design, No More Messy Wiring

Highly Integrated AlphaBot2-Pi Adapter Board:

IR Obstacle Avoidance, 5-Ch Detector LI Tracking, Battery Charging Circuit, High Quality N20 Motor, Rubber Wheels, And Colorful RGB LED



# Raspberry Pi 5MP HD Camera, 1080P

The Leading Role For Vision Applications, Like Mjpg-Streamer Video Monitoring, And OpenCV Intelligent Recognition Driving



# Full Functionality, Common Examples

For More Possibilities, Refer To Example Code And Manual



## Obstacle Avoidance

The module sends IR beam and detects objects by receiving the reflected IR beam, to easily avoid obstacles in the way.

## Auto Line Tracking

Features 5-ch IR detector for sensing and analysing the black line, combined with PID algorithm for adjusting robot movement, high sensitivity, stable tracking.

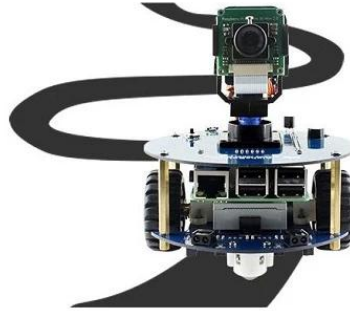

## Bluetooth Control

Provides mobile APP to control the robot movement and peripherals, such as RGB LED color, onboard buzzer, etc.

## Infrared Control

With the IR receiver onboard, it is allowed to control the robot via IR remote controller, make it move forward or change direction...



Web control (Mobile/Tablet/PC)    Qt software control (PC)    APP control (Android phone)



## WiFi Control

Supports WiFi remote control, real time video monitoring via webpage / APP / PC, also features routing function by creating WiFi hotspot.

## 2-DOF Pan-Tilt

2-DOF pan and tilt + hardware PWM controlled servo, smoothly rotates the camera to capture omnibearing images.







AlphaBot2-Pi robot RGB LED control



AlphaBot2-Pi robot video monitoring



AlphaBot2-Pi robot Bluetooth control

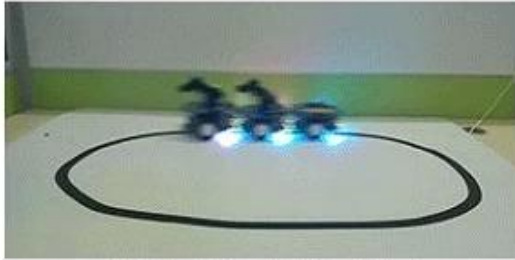

multi AlphaBot2 robots line following



AlphaBot2-Pi robot obstacle avoiding



# Kits Selection Guide

Various Raspberry Pi 4 Kits Are Available, Find Your Favorite One

## Starter Kit

The very essential parts to get started, guaranteed compatibility and stability.

- 16GB Class10 high speed micro SD card
- 5V 3A Type-C power supply
- Cool brass heat sink
- Extra free micro SD card reader



## Display Kit

Build your own all-in-one computer powered by Raspberry Pi 4, much more funny.

- 7inch wide viewing angle HD touch screen
- High quality black/white acrylic protective case
- HDMI to micro HDMI cable
- 16GB micro SD card, power supply...

## Sensor Kit Pi x Arduino

Sensors are important parts of IoT, while the Arduino is a massive ecosystem, this kit provides a way for the Pi to make use of these powerful things.

1 + 1 > 2

- Pi to Arduino adapter board
- 13x popular sensors
- 16GB micro SD card, power supply...



## Robot Kit AlphaBot

Make a Raspberry Pi smart mobile robot, easily use it for obstacle avoidance, line tracking, Bluetooth / IR / WiFi remote control, or video monitoring. Arduino compatible.

- AlphaBot driver board
- AlphaBot chassis
- Modules: Camera / Line tracking / Speed measuring...
- Raspberry Pi 4 is NOT included

## Robot Kit AlphaBot2

Make a Raspberry Pi smart mobile robot, easily use it for obstacle avoidance, line tracking, Bluetooth / IR / WiFi remote control, or video monitoring. A smaller and more flexible one.

- AlphaBot2-Pi (adapter board)
- AlphaBot2-Base (base chassis)
- Modules: Camera...



## Robot Arm Kit

Flexible and stable 4-DOF metal robot arm, allows to be controlled by smart phone through Bluetooth or WiFi connection.

"Just grab it"

- Servo driver board
- Metal mechanical arm structure
- 4x servos, power supply...
- Raspberry Pi 4 is NOT included





## O-LEADING *CUSTOMER*

To be *RELIABLE*

- Quality first ,
- Customer supreme ,
- Scientifically management ,
- Striving for famous brand



# THE CUSTOMER IS *KING*

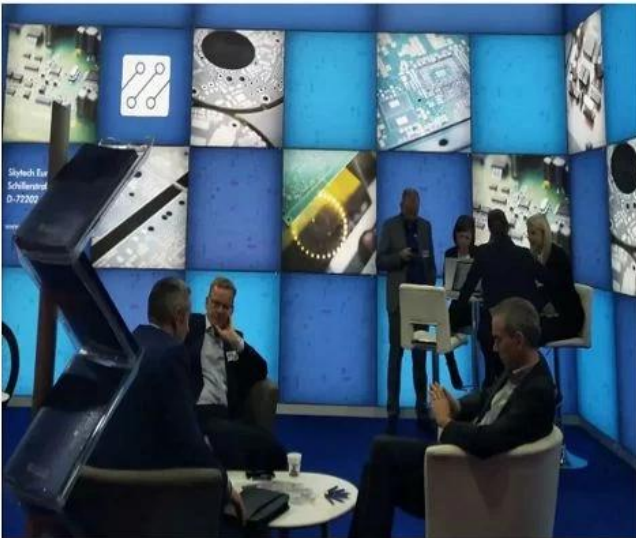

To be *VALUABLE*

- Science and technology keeps head ,
- Put people first,
- Be precise and practical,
- contribute sincerely

---

Factory PCB

---



Automatic vacuum press machine



Drilling Machine



Pattern Plating Machine



Scrubbing Machine



Developing Machine



Routing Machine



High-speed flying probe machine



E-test Machine

---

Factory SMT

---





# HOW O-LEADING MAKE A PROJECT FOR YOU

Hardware Dispenser Application Not

## Automatic Dispenser Application Not

Voltage Table

Volt Pin Number	Description
VDD	Battery voltage
+3V3	+3.3V
+5V	+5V
USB +5V	USB 5V input
+5V/2	Isolated +5V
+12V	12V DC Drive

STM32F072 PINOUT table

Wire Name	Description	DIO	Mode	Note
SMTN_TOF	Shutdown Time of flight sensor	Output	Logic '0' to shutdown	
I2C_SCL_TOF	I2C communication with time of flight sensor	I2C1_SCL		
I2C_SDA_TOF	I2C communication with thermopile sensor	I2C1_SDA		
I2C_SCL_IR	I2C communication with thermopile sensor	I2C2_SCL		
I2C_SDA_IR	I2C communication with thermopile sensor	I2C2_SDA		
RATE_LC	Load cell control pins	Output		
DOUT_LC	Load cell control pins	Output		

**O-LEADING**  
TO BE RELIABLE, TO BE AVAILABLE

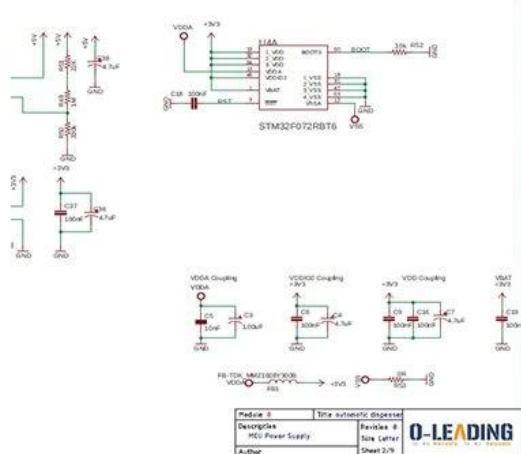

## HARDWARE schematics

## PCB PRODUCTION COMPONENTS SOURCING

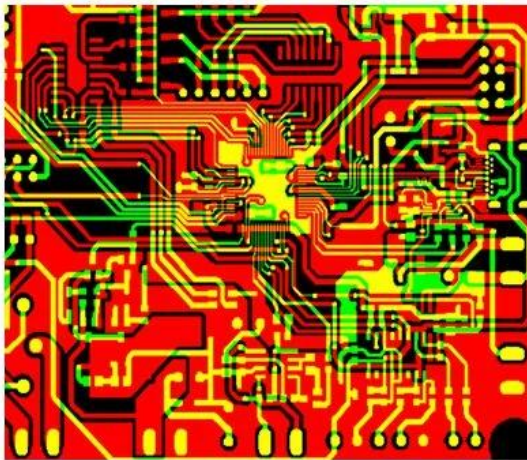

Qty	Value	Device	Parts	Description
4	AK500/2	AK500/2	X1, X2	CONNECTOR
1	AK500/3	AK500/3	X7	CONNECTOR
1	1241148	MA04-2	SV2	
1	PPPC04	MA04-2	SV1	8 POS, 4*2 FEMALE PIN HEAD
1	ML10	ML10	SV4	HARTING
1	8MHZ	XTALL_CSTCE8M	X5	STCE8M00G52-R0 RESONATOR
1	0R	R-0603	R53	Thick Film Resistors - SMD 0603
2	10R	R-0603	R12, R5	Thick Film Resistors - SMD 0603
8	100R	R-0603	R1, R2	Thick Film Resistors - SMD 0603
1	270R	R-0805	R15	Thick Film Resistors - SMD 0605
1	330R	R-0603	R11	Thick Film Resistors - SMD 0603
9	680R	R-0603	R20, R3	Thick Film Resistors - SMD 0603
17	1k	R-0603	R9, R10	Thick Film Resistors - SMD 0603
2	4.7k	R-0603	R17, R6	Thick Film Resistors - SMD 0603
2	5.1k	R-0603	R18, R1	Thick Film Resistors - SMD 0603
9	10k	R-0603	R16, R3	Thick Film Resistors - SMD 0603

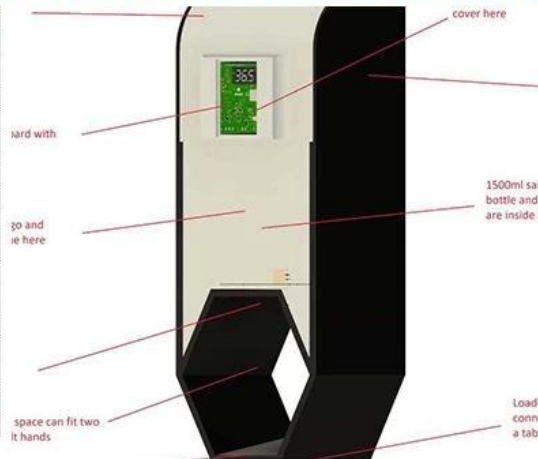
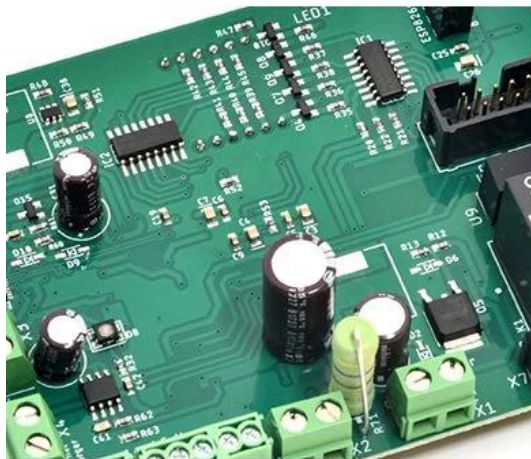

## PCB Assembly MECHANICAL DESIGN

Skyworth 创维

**HET** 和而泰  
HET INTELLIGENT CONTROL

dongweikeji  
东威科技

美的 Midea

STAR-NET  
星网锐捷

FORYOU  
ADAYO 华阳集团

**EDIFIER**<sup>®</sup>

Cultraview 金锐显

3nod 三诺

**T&W**

**TCL**

AcBel 康舒科技  
ACBEL POLYTECH INC.

**Honeywell**

Schneider  
Electric

**ZTE** 中兴

**EMERSON**

**BYD**

**PHILIPS**

**TE**  
connectivity

**VIDEOTON**

CUSTOMER VOICE IS **EXTREMELY IMPORTANT** TO US

<p>订单编号: 49335463501024670</p> <p>供应商服务: 非常满意 (5 stars) 按时发货: 非常满意 (5 stars)</p> <p><b>High quality usb power pcb , pcba manufacturer</b> ★★★★★ Fancy has done an excellent job, whenever we write, she answered us within 1 second, O-leading is very perfect with fast delivery, fast logistics, the most important thing is good quality, good packaging, thank you!</p> <p><a href="#">回复该评论</a></p> <p><b>oem customized rohs pcb drawing schematic s...</b> ★★★★★ We received the boards, the quality is very good, the price is very reasonable, Fancy is very nice &amp; smart &amp; experienced, the logistics is super fast, I will come to see more in the future.</p> <p><a href="#">回复该评论</a></p>	<p>订单编号: 49922411001024670</p> <p>供应商服务: 非常满意 (5 stars) 按时发货: 非常满意 (5 stars)</p> <p><b>High TG180 FR-4 Circuit HDI PCB 94V0 Board...</b> ★★★★★ This is a very difficult PCB design, but we are lucky to find O-leading to support the PCB for us very good to a PCB supplier.</p> <p><b>universal FR4 Multilayer PCB washing machine...</b> ★★★★★ Fancy gives us very excellent service, very professional and experienced, O-leading is the best one of our suppliers, very happy to work with them.</p>
<p>订单编号: 49298271001024670</p> <p>供应商服务: 非常满意 (5 stars) 按时发货: 非常满意 (5 stars)</p> <p><b>High TG180 FR-4 Circuit HDI PCB 94V0 Board ...</b> ★★★★★ perfect product, perfect PCB supplier!</p> <p><a href="#">回复该评论</a></p> <p><b>oem customized rohs pcb drawing schematic s...</b> ★★★★★ Very good and professional PCB product as usual!</p> <p><a href="#">回复该评论</a></p> <p><b>Strip LED Aluminum FR-4 lighting PCB board 9...</b> ★★★★★ High quality, fast delivery, good service, competitive price, lucky and happy to purchase from O-leading!</p> <p><a href="#">回复该评论</a></p>	<p>订单编号: 49024962001024670</p> <p>United States 供应商服务: 非常满意 (5 stars) 按时发货: 非常满意 (5 stars)</p> <p><b>High quality Keyboard pcb &amp; pcba Factory SMT...</b> ★★★★★ Top quality, it's the right choice to choose O-leading to make the PCB &amp; PCBA</p> <p><a href="#">回复该评论</a></p>
	<p>订单编号: 499862201024670</p> <p>供应商服务: 非常满意 (5 stars) 按时发货: 非常满意 (5 stars)</p> <p><b>Professional Printed Circuit Board Manufactur...</b> ★★★★★ Very high quality PCB products, O-leading is the best PCB supplier that we have ever worked with.</p>
	<p>订单编号: 44068794501034670</p> <p>供应商服务: 非常满意 (5 stars) 按时发货: 非常满意 (5 stars)</p> <p><b>High TG180 FR-4 Circuit HDI PCB 94V0 Board ...</b> ★★★★★ We bought two batches, one by DHL, the other one by air, good quality and fast delivery!</p>

LISTEN TO **CUSTOMER VOICE**

<p>订单编号: 40903347501024670</p> <p>供应商服务: 非常满意 (5 stars) 按时发货: 非常满意 (5 stars)</p> <p><b>Strip LED Aluminum FR-4 lighting PCB board 9...</b> ★★★★★ Very fast delivery! Fantastic, good job!!</p> <p><b>Professional Printed Circuit Board Manufactur...</b> ★★★★★ Very happy to great support from O-leading, they are not only professional on the PCB, but also provide good PCB products, very good supplier!</p>	<p>订单编号: 36919647001024670</p> <p>供应商服务: 非常满意 (5 stars) 按时发货: 非常满意 (5 stars)</p> <p><b>AML-S802 Quad-core Android embedded boar...</b> ★★★★★ Good products</p> <p><b>Fast delivery low cost pcb fabrication O-leadin...</b> ★★★★★ Good supplier</p>
<p><b>hot sale rigid-flexible PCB with 0.2mm BGA an...</b> ★★★★★ very professional supplier</p> <p><b>High Quality custom FPCB/Flex PCB/FPC/Flexi...</b> ★★★★★ Good product</p> <p><b>OEM ODM PCBA Bluetooth Wireless Marking G...</b> ★★★★★ high soldering quality</p> <p><b>Electronic parts haptic pcba Circuit Board asse...</b> ★★★★★ Very Good product</p>	<p><b>Lidar IR Sensor board pcba(H08R6x)</b> ★★★★★ perfect product</p> <p><b>Customized PCBA design PCB design</b> ★★★★★ perfect</p> <p><b>Audio Speaker and Headphone Jack (H07R3x)</b> ★★★★★ High quality, good</p>
<p>订单编号: 37378603001024670</p> <p>供应商服务: 非常满意 (5 stars) 按时发货: 非常满意 (5 stars)</p> <p><b>Raspberry pi 0 Zero Raspberry Pi Zero PI W ver...</b> ★★★★★ Fantastic products!!</p> <p><b>double layer pcb with red S/M and LF-HASL su...</b> ★★★★★ Good!</p>	<p><b>half hole pcb, half hole pcb module, half hole m...</b> ★★★★★ Top half hole pcb supplier, very perfect goods</p> <p><b>High Quality custom FPCB/Flex PCB/FPC/Flexi...</b> ★★★★★ this rigid-flexible pcb quality is perfect!</p> <p><b>Electronic parts haptic pcba Circuit Board asse...</b> ★★★★★ Very satisfied with O-leading products and quality, especially their on-time delivery, fantastic!</p>

Be kind to your client, because he has many choices, but he chooses you instead.





## O-LEADING TRAINING



### Keep *LEARNING*

There's a phrase in Buddhism, 'Beginner's mind.'

It's wonderful to have a beginner's mind

## WE HAVE A *DREAM*

### Keep *RUNNING*

I would like to live to study, and not study to live.

----Bacon

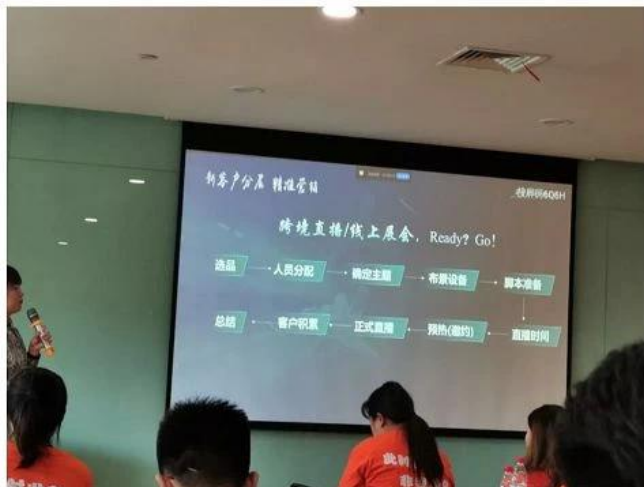





**Test Report** No. SZXEC1900530401 Date: 30 Mar 2019 Page 1 of 6

O-LEADING SUPPLY CHAIN (HK) CO., LIMITED  
1313.FLOOR 13, FORTUNE BUILDING, DANSHUI TOWN, HUIYANG DISTRICT, HUIZHOU, GUANGDONG, CHINA

The following sample(s) was/were submitted and identified on behalf of the clients as : OSP

SGS Job No. : RP19-005089 - SZ  
Date of Sample Received : 22 Mar 2019  
Testing Period : 22 Mar 2019 - 30 Mar 2019  
Test Requested : Selected test(s) as requested by client.  
Test Method : Please refer to next page(s).  
Test Results : Please refer to next page(s).

Conclusion : Based on the performed tests on submitted sample(s), the results of Lead, Mercury, Cadmium, Hexavalent chromium, Polybrominated biphenyls (PBBs), Polybrominated diphenyl ethers (PBDEs) and Phthalates such as Bis(2-ethylhexyl) phthalate (DEHP), Butyl benzyl phthalate (BBP), Dibutyl phthalate (DBP), and Diisobutyl phthalate (DIBP) comply with the limits as set by RoHS Directive (EU) 2015/863 amending Annex II to Directive 2011/65/EU.

Signed for and on behalf of  
SGS-CSTC Standards Technical Services Co., Ltd. Shenzhen Branch

*Tina*  
Tina Fan  
Approved Signatory



Unless otherwise agreed in writing, this document is issued by the Company subject to its General Conditions of Service printed on the reverse side of this document or available at [www.sgs.com](http://www.sgs.com). The Client's attention is drawn to the limitation of liability, indemnification and jurisdiction clauses defined therein. Any holder of this document is advised that information contained herein reflects the Company's findings at the time of its intervention only and within the limits of the Client's instructions. In any event, the Company's sole responsibility is to its Client and the document does not exonerate parties to a transaction from respecting all their rights and obligations under the transaction documents. This document cannot be reproduced or used in any manner whatsoever without the prior written approval of the Company. Any unauthorized alteration, forgery or falsification of the content or appearance of this document is unlawful and offenders may be prosecuted to the fullest extent of the law. Unless otherwise stated the validity shown in this report refers only to the samples tested.

Attention: To check the authenticity of testing SGS-CSTC Reports & certificates, please contact us at telephone: (86-755) 8307 1443 or e-mail: [CN.Certification@sgs.com](mailto:CN.Certification@sgs.com)

SGS 检测有限公司 深圳分公司 地址: 深圳市福田区福安路 518129 邮编: 518129 电话: (86-755) 25288888 / (86-755) 8307 1443  
www.sgs.com.cn

Member of the SGS Group (SGS SA)



**Test Report** No. SZXEC1900530401 Date: 30 Mar 2019 Page 2 of 6

Test Results :

Test Part Description :

Specimen No.	SGS Sample ID	Description
SN1	SZX19-005304.001	Green"PCB"

- Remarks :
- (1) 1 mg/kg = 1 ppm = 0.0001%
  - (2) MDL = Method Detection Limit
  - (3) ND = Not Detected (< MDL)
  - (4) "-" = Not Regulated

RoHS Directive (EU) 2015/863 amending Annex II to Directive 2011/65/EU

Test Method : With reference to IEC 62321-4:2013+A1:2017, IEC62321-5:2013, IEC62321-7-2:2017, IEC 62321-6:2015 and IEC62321-8:2017, analyzed by ICP-OES, UV-Vis and GC-MS.

Test Item(s)	Limit	Unit	MDL	0/1
Cadmium (Cd)	100	mg/kg	2	ND
Lead (Pb)	1,000	mg/kg	2	8
Mercury (Hg)	1,000	mg/kg	2	ND
Hexavalent Chromium (Cr(VI))	1,000	mg/kg	8	ND
Sum of PBBs	1,000	mg/kg	-	ND
Monobromobiphenyl	-	mg/kg	5	ND
Dibromobiphenyl	-	mg/kg	5	ND
Tribromobiphenyl	-	mg/kg	5	ND
Tetrabromobiphenyl	-	mg/kg	5	ND
Pentabromobiphenyl	-	mg/kg	5	ND
Hexabromobiphenyl	-	mg/kg	5	ND
Heptabromobiphenyl	-	mg/kg	5	ND
Octabromobiphenyl	-	mg/kg	5	ND
Nonabromobiphenyl	-	mg/kg	5	ND
Decabromobiphenyl	-	mg/kg	5	ND
Sum of PBDEs	1,000	mg/kg	-	ND
Monobromodiphenyl ether	-	mg/kg	5	ND
Dibromodiphenyl ether	-	mg/kg	5	ND
Tribromodiphenyl ether	-	mg/kg	5	ND
Tetrabromodiphenyl ether	-	mg/kg	5	ND
Pentabromodiphenyl ether	-	mg/kg	5	ND



Unless otherwise agreed in writing, this document is issued by the Company subject to its General Conditions of Service printed on the reverse side of this document or available at [www.sgs.com](http://www.sgs.com). The Client's attention is drawn to the limitation of liability, indemnification and jurisdiction clauses defined therein. Any holder of this document is advised that information contained herein reflects the Company's findings at the time of its intervention only and within the limits of the Client's instructions. In any event, the Company's sole responsibility is to its Client and this document does not exonerate parties to a transaction from respecting all their rights and obligations under the transaction documents. This document cannot be reproduced or used in any manner whatsoever without the prior written approval of the Company. Any unauthorized alteration, forgery or falsification of the content or appearance of this document is unlawful and offenders may be prosecuted to the fullest extent of the law. Unless otherwise stated the validity shown in this report refers only to the samples tested.

Attention: To check the authenticity of testing SGS-CSTC Reports & certificates, please contact us at telephone: (86-755) 8307 1443 or e-mail: [CN.Certification@sgs.com](mailto:CN.Certification@sgs.com)

SGS 检测有限公司 深圳分公司 地址: 深圳市福田区福安路 518129 邮编: 518129 电话: (86-755) 25288888 / (86-755) 8307 1443  
www.sgs.com.cn

Member of the SGS Group (SGS SA)



## ZPMV2.E490354 - WIRING, PRINTED - COMPONENT

## Wiring, Printed - Component

See General Information for Wiring, Printed - Component

**O-LEADING SUPPLY CHAIN (HK) CO LTD**

E490354

ROOM 1205, 12/F  
TAI SANG BANK BLDG  
130-132 DES VOEUS ROAD  
CENTRAL, HONG KONG

Type	Cond Width		Cond Thk	SS/ DS/ DSO	Max Area Diam	Max Solder Limits		Max Oper Temp		Meets UL796	C
	Min	Edge				C	sec	C	Class		
	mm(in)	mm(in)	mic(mil)		mm(in)	C	sec	C	Class	DSR	I
<b>Multilayer (mass laminate) printed wiring boards.</b>											
<b>O-LEADING-401</b>	0.1 (0.004)	0.3 (0.012)	34 (1.34)	DS	12.7 (0.5)	260	10	130	V-0	-	-
<b>O-LEADING-407</b>	0.08 (0.003)	0.2 (0.008)	17 (0.67)	DS	9.7 (0.4)	260	10	130	V-0	All	-
<b>Multilayer printed wiring boards.</b>											
<b>O-LEADING-408</b>	0.125 (0.005)	0.125 (0.005)	12 (0.47) Int:136	DS	50.8 (2.0)	280	20	130	V-0	All	*
<b>Single layer printed wiring boards.</b>											
<b>O-LEADING-002</b>	0.38 (0.015)	1.14 (0.045)	34 (1.34)	SS	19.1 (0.8)	260	10	105	V-0	All	-
<b>O-LEADING-003</b>	0.38 (0.015)	1.14 (0.045)	34 (1.34)	SS	19.1 (0.8)	260	10	130	V-0	▲	-
<b>O-LEADING-033</b>	0.15 (0.006)	0.3 (0.012)	34 (1.34)	SS	25.4 (1.0)	260	10	120	V-0	All	-
<b>O-LEADING-205</b>	0.1 (0.004)	0.3 (0.012)	34 (1.34)	DS	69.6 (2.7)	260	10	130	V-0	All	-
<b>O-LEADING-206</b>	0.15 (0.006)	0.33 (0.013)	17 (0.67)	DS	69.6 (2.7)	260	10	130	V-0	All	-
<b>O-LEADING-D01</b>	0.14 (0.006)	0.15 (0.006)	33 (1.30)	DS	25.4 (1.0)	260	10	130	V-0	All	*
<b>O-LEADING-S01</b>	0.25 (0.010)	0.25 (0.010)	17 (0.67)	SS	25.4 (1.0)	260	4	130	V-0	All	*

## WIRING, PRINTED - COMPONENT | UL Product iQ

<b>O-LEADING-S02</b>	0.2 (0.008)	0.2 (0.008)	17 (0.67)	SS	25.4 (1.0)	260	4	130	HB	▲	*
<b>O-LEADING-S03</b>	0.25 (0.010)	0.25 (0.010)	34 (1.34)	SS	25.4 (1.0)	260	4	130	V-0	All	*

\* - CTI marking is optional and may be marked on the printed wiring board.

Marking: Company name or file number and type designation. May be followed by a suffix to denote factory identification or burning test classification.

并不是所有出现在本数据库中的公司名称和产品都满足了UL跟踪检验服务的要求。只有带有UL标志的产品，才应该被视为经过UL认证，并满足UL跟踪检验服务的要求。注意查看产品上的标志。

UL允许在线认证目录中所含材料的复制遵循以下条件：1.指南信息、装配、构造、设计、系统和/或认证（文件）必须在不篡改任何数据（或图纸）的情况下完整且无误导性地呈现。2.经UL允许从在线认证目录转载“声明必须出现在所提取材料的邻近位置。此外，转载材料必须包含以下格式的版权声明：“© 2019 UL LLC”



<b>PCB</b>	
Layer	1LAYER-32LAYER
Weight	1/3oz-12oz
Thickness	3.0mil / 3.0mil
Core Thickness	4.0mil / 4.0ml
Drill Size	10µ
Panel Size	0.2mm-5.0mm
Panel Dimensions	635 * 1500mm
Surface Finish	4mil
Surface Tolerance	+/- 3mil
Surface Treatment	OSP
VIA	Microvia
Material	FR-4 FR-4HIGH TG
Surface Treatment	HASL OSP ENIG HAL-LF LMM LMM

### SMT

PCB	FR-4 CEM-1 CEM-3 FPC
PCB Size	510x1500mm
PCB Size	50x50mm
PCB Thickness	0.5mm-4.5mm
Drill Size	0.5~4mm
Drill Size	0201.
Drill Size	0603
Drill Size	15mm
Drill Size	0.3mm
BGA	0.4mm
Drill Size	+/- 0.03mm



# Shipping service





Quick Turn Lead Time		
Layer Count:	Lead Tim	Special Requirement
1L/2L	2-3days	24 Hours,48 Hours
4L	3-4days	48 Hours
6L	4-5days	72 Hours
8L	5-6days	NA
10L	6-7days	NA
12L	7-8days	NA
14L	8-9days	NA

Standard Lead Time		
Layer Count:	Sample Lead Time	Volume order lead time
2L	4 days	10 days
4L	5 days	11 days
6L	6 days	12 days
8L	8 days	14 days
10L	10 days	16 days
12L	12 days	18 days
14L	14 days	20 days
16-32L	18 days	24 days



**1. 质量管理体系**

- 1.1 符合ISO 9001:2008 质量管理体系
- 1.2 符合ISO 14001 环境管理体系
- 1.3 符合IPC-A-6000 X-Ray AOI 检测标准及ICT 测试标准
- 1.4 符合IPC-6013 验收标准
- 1.5 符合ISO 9001 认证

**2. 生产与交付**

我们提供10天快速交货服务，2-3天样品交付，RMB 31元/天/板。我们提供O-2000 表面处理，符合IPC-6013 验收标准。我们提供符合IPC-6013 验收标准的PCB 生产服务。

**3. 材料选择**

我们提供FR4 和TG 材料，符合IPC-6013 验收标准/符合IPC-6013 验收标准。

**4. PCB/PCBA**

- 4.1 BOM
- 4.2 PCB Gerber
- 4.3 PCB/PCBA
- 4.4
- 4.5

**5. PCB**

→ AOI → PTH → E / T

**6. HDI**

VCP LDI LDI

**7. Surface Finish O-Lead**

ENIG OSP LF-HASL HDI OSP ENIG OSP + ENIG BGA 0.3 mm OSP OSP + ENIG

**8. FPC o-Source SMT**

O-LAIDE 8 FPC 2000mm \* 240mm "Flex Capability" SMT

**PCB**

; PCB; PCB

**10. PCB/PWB/FPC**

PCB PWB FPC

**11. PCB**

PCB TG CTE 250°C 50 PCB PCB

**12. o-Light Rigid-Flex PCB**

o-LAIDE RIGID-FLEX PCB FPC PCB

**13.**

SI6000 Polar Instruments CITS00S