

# Benvenuto in O-leading

O-Leading si impegna a essere il tuo partner unico nella catena di fornitura EMS, tra cui progettazione PCB, fabbricazione PCB e assemblaggio PCB (PCBA), forniamo alcune delle tecnologie PCB più avanzate, inclusi PCB HDI, PCB multistrato, PCB rigido-flessibili Siamo in grado di supportare dal prototipo a rotazione rapida alla produzione media e di massa. ([CProgettazione e produzione di schede elettroniche Assemblaggio di PCB e PCBA](#))

In generale, i nostri clienti globali sono molto colpiti dai nostri servizi: risposta rapida, prezzo competitivo e impegno per la qualità. Fornire un servizio tecnico più prezioso e una soluzione globale è la strada che porta avanti.

Guardando al futuro, O-leading si concentrerà come sempre sull'innovazione e lo sviluppo della tecnologia di produzione di componenti elettronici e farà sforzi persistenti sul servizio one-stop PCB e PCBA per fornire servizi di prima classe e creare più valore per i nostri clienti.

FARE CLIC QUI PER MAGGIORI INFORMAZIONI [EFabbrica elettronica Pcba del sensore dell'assemblea del circuito stampato a 4 strati dell'OEM](#)

## Descrizione del prodotto

# HOW O-LEADING MAKE A PROJECT FOR YOU

Hardware Dispenser Application Not

## Automatic Dispenser Application Not

Voltage Table

Volt Pin Number	Description
VDD	Battery voltage
+3V3	+3.3V
+5V	+5V
USB +5V	USB 5V input
+5V/2	Isolated +5V
+12V	12V DC Drive

STM32F072 PINOUT table

Wire Name	Description	DIO	Mode	Note
SMTN_TOF	Shutdown Time of flight sensor	Output		Logic '0' to shutdown
I2C_SCL_TOF	I2C communication with time of flight sensor	I2C1_SCL		
I2C_SDA_TOF	I2C communication with thermopile sensor	I2C1_SDA		
I2C_SCL_IR	I2C communication with thermopile sensor	I2C2_SCL		
I2C_SDA_IR	I2C communication with thermopile sensor	I2C2_SDA		
RATE_LC	Load cell control pins	Output		
DOUT_LC	Load cell control pins	Output		

**O-LEADING**  
TO BE RELIABLE, TO BE AVAILABLE

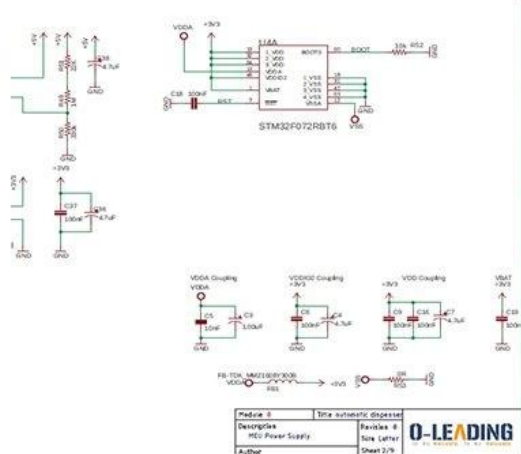

## HARDWARE schematics

## PCB PRODUCTION COMPONENTS SOURCING

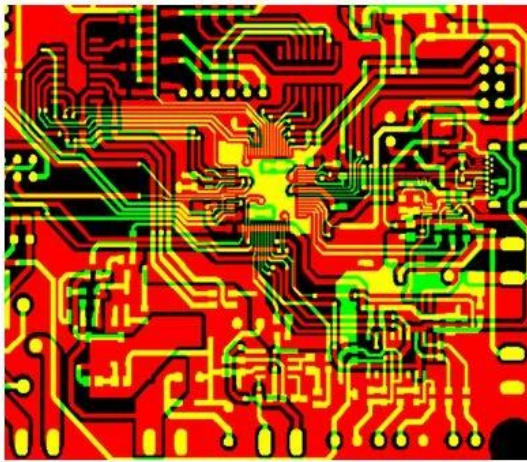

Qty	Value	Device	Parts	Description
4	AK500/2	AK500/2	X1, X2	CONNECTOR
1	AK500/3	AK500/3	X7	CONNECTOR
1	1241148	MA04-2	SV2	
1	PPPC04	MA04-2	SV1	8 POS, 4*2 FEMALE PIN HEAD
1	ML10	ML10	SV4	HARTING
1	8MHZ	XTALL_CSTCE8M	X5	STCE8M00G52-R0 RESONATOR
1	0R	R-0603	R53	Thick Film Resistors - SMD 0603
2	10R	R-0603	R12, R5	Thick Film Resistors - SMD 0603
8	100R	R-0603	R1, R2	Thick Film Resistors - SMD 0603
1	270R	R-0805	R15	Thick Film Resistors - SMD 0605
1	330R	R-0603	R11	Thick Film Resistors - SMD 0603
9	680R	R-0603	R20, R3	Thick Film Resistors - SMD 0603
17	1k	R-0603	R9, R10	Thick Film Resistors - SMD 0603
2	4.7k	R-0603	R17, R6	Thick Film Resistors - SMD 0603
2	5.1k	R-0603	R18, R1	Thick Film Resistors - SMD 0603
9	10k	R-0603	R16, R3	Thick Film Resistors - SMD 0603

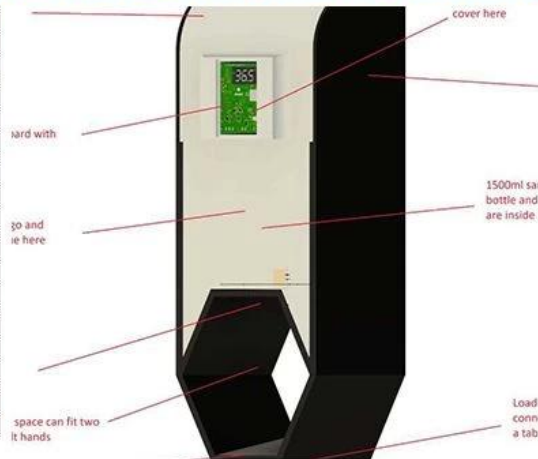

## PCB Assembly MECHANICAL DESIGN

TOP QUALITY PCBA

**O-LEADING**

To Be Reliable, To Be Valuable



MAKE YOUR IDEA COME **TRUE**

TOP QUALITY PCBA

**O-LEADING**

To Be **Reliable**, To Be **Valuable**

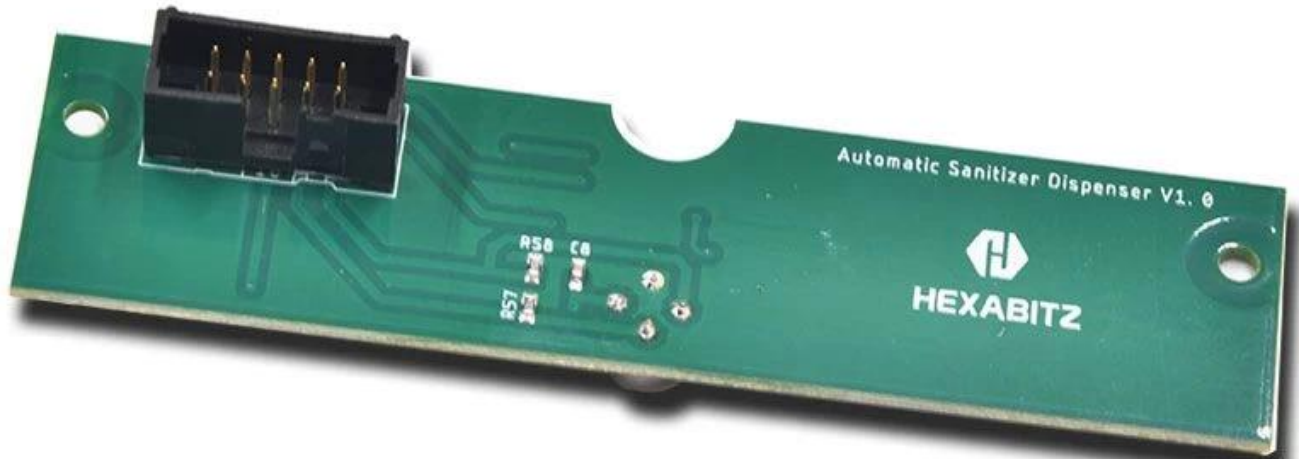

MAKE YOUR IDEA COME **TRUE**

TOP QUALITY PCBA

**O-LEADING**

To Be Reliable, To Be Valuable

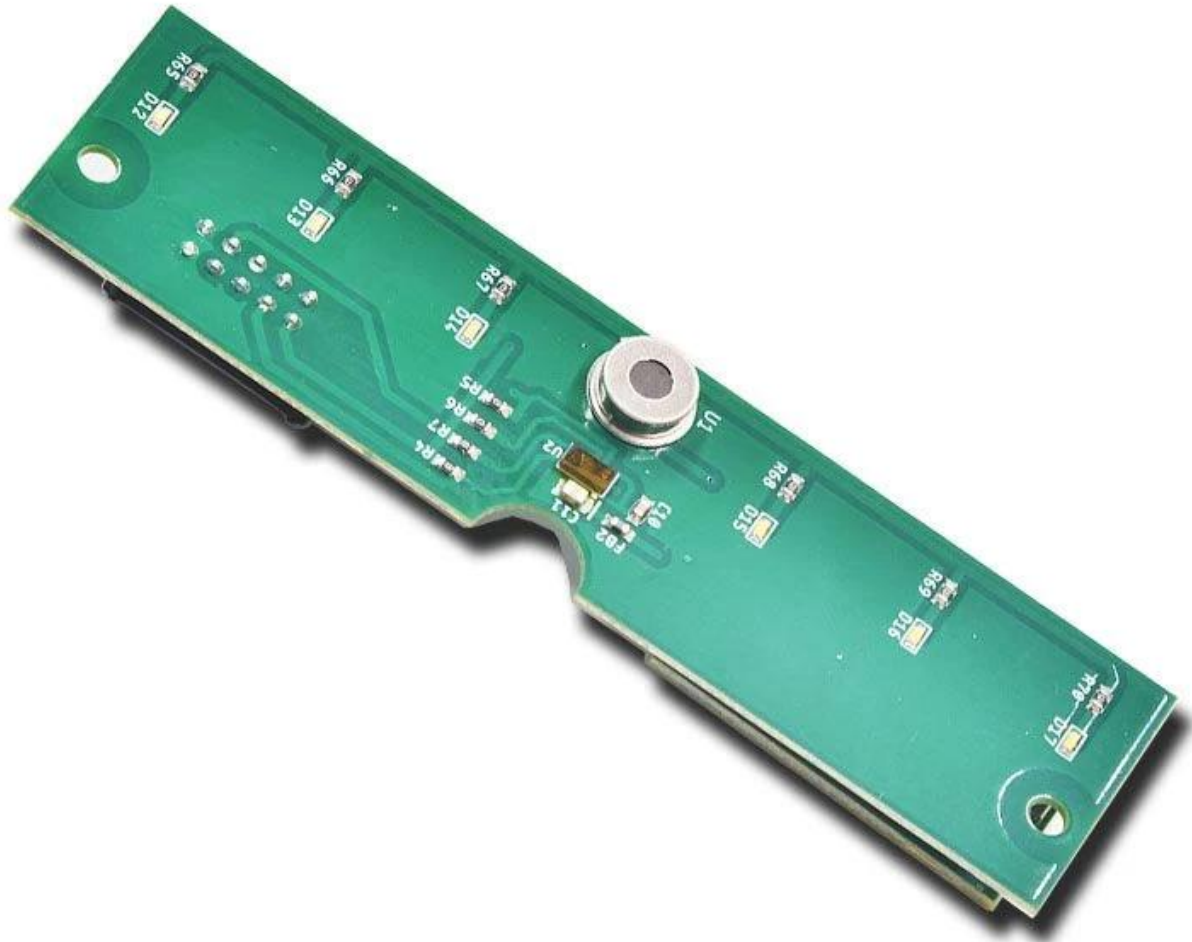

MAKE YOUR IDEA COME TRUE



## Process Flow Chart

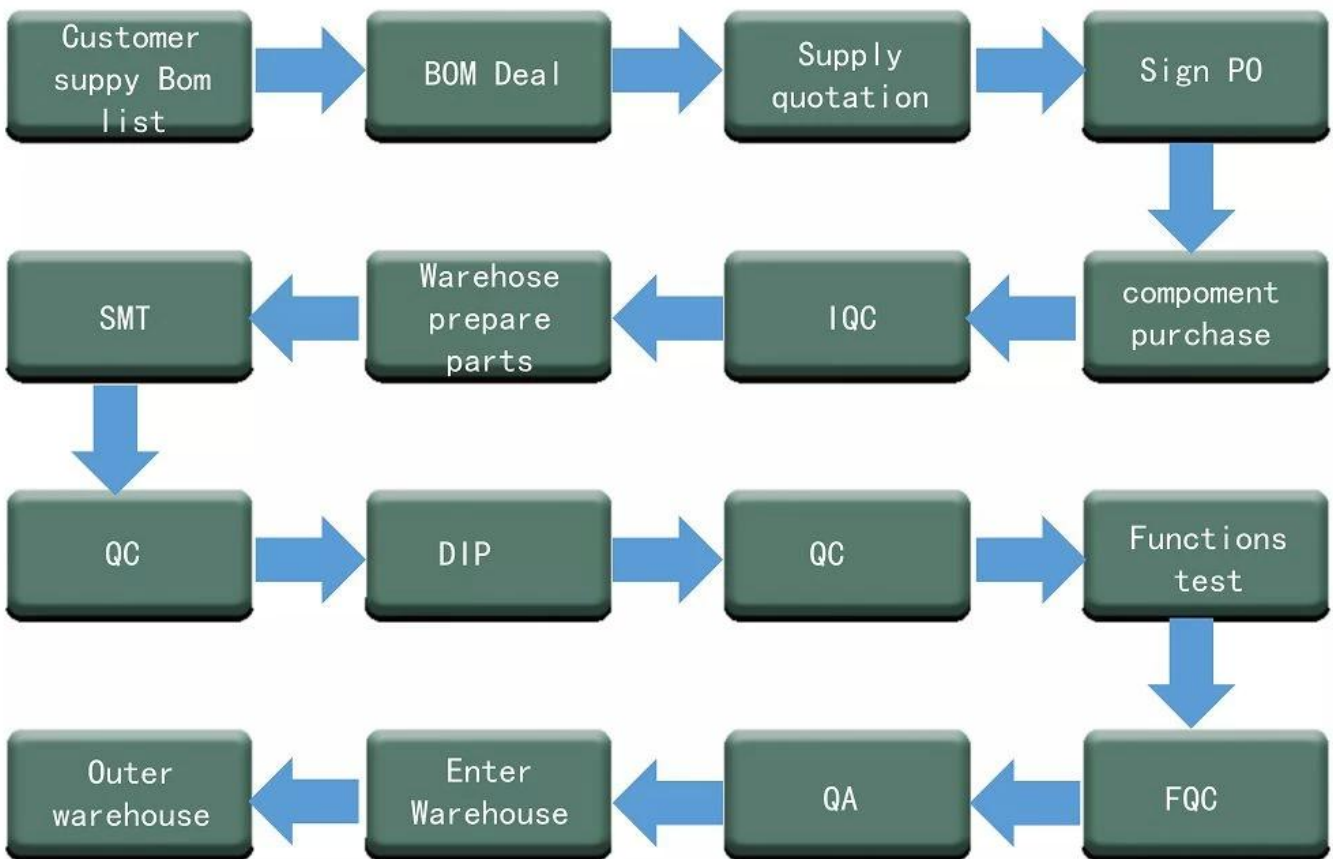

## Quality Control Process

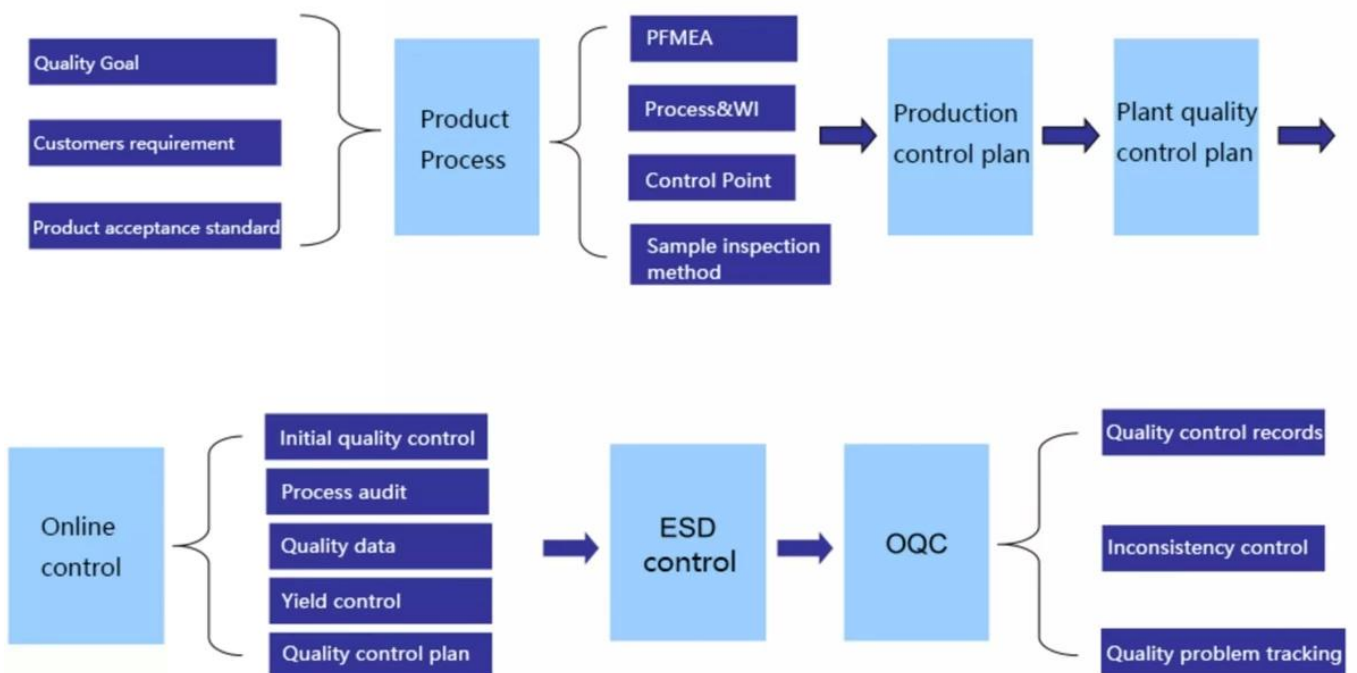



## La nostra squadra

O-LEADING *CUSTOMER*

To be *RELIABLE*

- Quality first ,
- Customer supreme ,
- Scientifically management ,
- Striving for famous brand



*THE CUSTOMER IS KING*

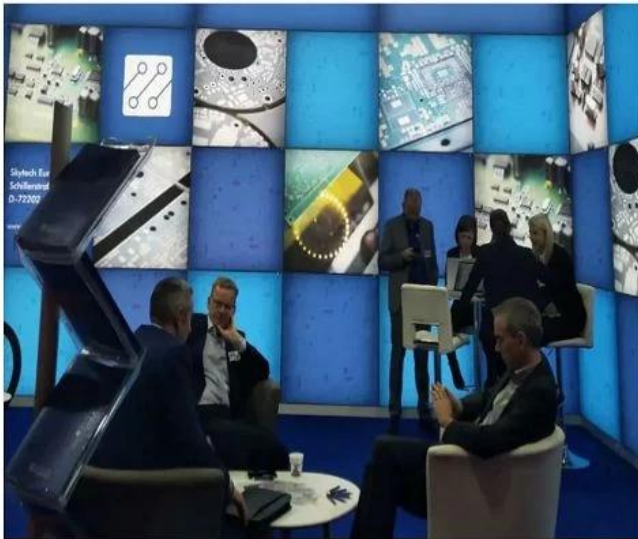

To be *VALUABLE*

- Science and technology keeps head ,
- Put people first ,
- Be precise and practical ,
- contribute sincerely

---

Factory PCB

---



Automatic vacuum press machine



Drilling Machine



Pattern Plating Machine



Scrubbing Machine



Developing Machine



Routing Machine



High-speed flying probe machine



E-test Machine

---

Factory SMT

---





Skyworth 创维

**HET** 和而泰  
HET INTELLIGENT CONTROL

dongweikeji  
东威科技

美的 Midea

STAR-NET  
星网锐捷

FORYOU  
ADAYO 华阳集团

**EDIFIER**<sup>®</sup>

Cultraview 金锐显

3nod 三诺

**T&W**

**TCL**

AcBel 康舒科技  
ACBEL POLYTECH INC.

**Honeywell**

Schneider  
Electric

**ZTE** 中兴

**EMERSON**

**BYD**

**PHILIPS**

**TE**  
connectivity

**VIDEOTON**

CUSTOMER VOICE IS **EXTREMELY IMPORTANT** TO US

订单编号: 49335463501024670

供应商服务: 非常满意 (5 stars) 按时发货: 非常满意 (5 stars)



**High quality usb power pcb , pcba manufacturer**

★★★★★

Fancy has done an excellent job, whenever we write, she answered us within 1 second, O-leading is very perfect with fast delivery, fast logistics, the most important thing is good quality, good packaging, thank you!

[回复该评论](#)



**oem customized rohs pcb drawing schematic s...**

★★★★★

We received the boards, the quality is very good, the price is very reasonable, Fancy is very nice & smart & experienced, the logistics is super fast, I will come to see more in the future.

[回复该评论](#)

订单编号: 490224962001024670

United States

供应商服务: 非常满意 (5 stars) 按时发货: 非常满意 (5 stars)



**High TG180 FR-4 Circuit HDI PCB 94V0 Board...**

★★★★★

This is a very difficult PCB design, but we are lucky to find O-leading to support the PCB for us very good to a PCB supplier.



**universal FR4 Multilayer PCB washing machine...**

★★★★★

Fancy gives us very excellent service, very professional and experienced, O-leading is the best one of our suppliers, very happy to work with them.

订单编号: 49298271001024670

供应商服务: 非常满意 (5 stars) 按时发货: 非常满意 (5 stars)



**High TG180 FR-4 Circuit HDI PCB 94V0 Board ...**

★★★★★

perfect product, perfect PCB supplier!

[回复该评论](#)



**oem customized rohs pcb drawing schematic s...**

★★★★★

Very good and professional PCB product as usual!

[回复该评论](#)



**Strip LED Aluminum FR-4 lighting PCB board 9...**

★★★★★

High quality, fast delivery, good service, competitive price, lucky and happy to purchase from O-leading!

[回复该评论](#)

订单编号: 4939862201024670

供应商服务: 非常满意 (5 stars) 按时发货: 非常满意 (5 stars)



**High quality Keyboard pcb & pcba Factory SMT...**

★★★★★

Top quality, it's the right choice to choose O-leading to make the PCB & PCBA

[回复该评论](#)



**Professional Printed Circuit Board Manufactur...**

★★★★★

Very high quality PCB products, O-leading is the best PCB supplier that we have ever worked with.

订单编号: 44068794501034670

供应商服务: 非常满意 (5 stars) 按时发货: 非常满意 (5 stars)



**High TG180 FR-4 Circuit HDI PCB 94V0 Board ...**

★★★★★

We bought two batches, one by DHL, the other one by air, good quality and fast delivery!

LISTEN TO **CUSTOMER VOICE**

订单编号: 40903347501024670

供应商服务: 非常满意 (5 stars) 按时发货: 非常满意 (5 stars)



**Strip LED Aluminum FR-4 lighting PCB board 9...**

★★★★★

Very fast delivery! Fantastic, good job!!



**Professional Printed Circuit Board Manufactur...**

★★★★★

Very happy to great support from O-leading, they are not only professional on the PCB, but also provide good PCB products, very good supplier!

订单编号: 36919647001024670

供应商服务: 非常满意 (5 stars) 按时发货: 非常满意 (5 stars)



**AML-S802 Quad-core Android embedded boar...**

★★★★★

Good products



**Fast delivery low cost pcb fabrication O-leadi...**

★★★★★

Good supplier

订单编号: 37378603001024670

供应商服务: 非常满意 (5 stars) 按时发货: 非常满意 (5 stars)



**hot sale rigid-flexible PCB with 0.2mm BGA an...**

★★★★★

very professional supplier



**High Quality custom FPCB/Flex PCB/FPC/Flexi...**

★★★★★

Good product



**OEM ODM PCBA Bluetooth Wireless Marking G...**

★★★★★

high soldering quality



**Electronic parts haptic pcba Circuit Board asse...**

★★★★★

Very Good product

订单编号: 37378603001024670

供应商服务: 非常满意 (5 stars) 按时发货: 非常满意 (5 stars)



**Lidar IR Sensor board pcba(H08R6x)**

★★★★★

perfect product



**Customized PCBA design PCB design**

★★★★★

perfect



**Audio Speaker and Headphone Jack (H07R3x)**

★★★★★

High quality, good

订单编号: 37378603001024670

供应商服务: 非常满意 (5 stars) 按时发货: 非常满意 (5 stars)



**Raspberry pi 0 Zero Raspberry Pi Zero PI W ver...**

★★★★★

Fantastic products!!



**double layer pcb with red S/M and LF-HASL su...**

★★★★★

Good!

订单编号: 37378603001024670

供应商服务: 非常满意 (5 stars) 按时发货: 非常满意 (5 stars)



**half hole pcb, half hole pcb module, half hole m...**

★★★★★

Top half hole pcb supplier, very perfect goods



**High Quality custom FPCB/Flex PCB/FPC/Flexi...**

★★★★★

this rigid-flexible pcb quality is perfect!



**Electronic parts haptic pcba Circuit Board asse...**

★★★★★

Very satisfied with O-leading products and quality, especially their on-time delivery, fantastic!

Be kind to your client, because he has many choices, but he chooses you instead.

# Certificazioni

O-LEADING *TRAINING*



Keep *LEARNING*

There's a phrase in Buddhism, 'Beginner's mind.'

It's wonderful to have a beginner's mind

WE HAVE A *DREAM*

Keep *RUNNING*

I would like to live to study, and not study to live.

----Bacon

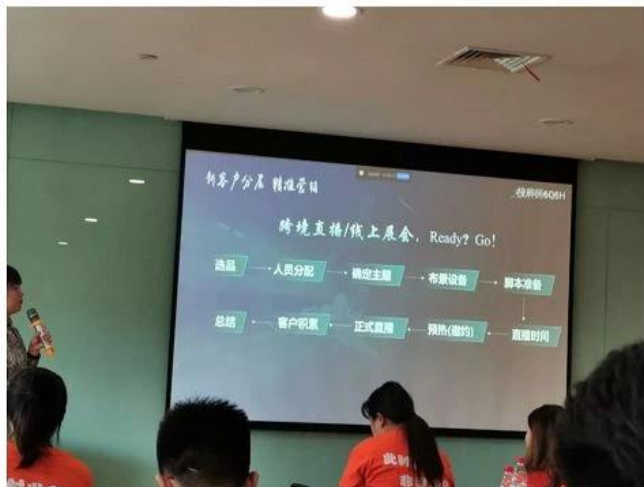





**Test Report** No. SZXEC1900530401 Date: 30 Mar 2019 Page 1 of 6

O-LEADING SUPPLY CHAIN (HK) CO., LIMITED  
1313.FLOOR 13, FORTUNE BUILDING, DANSHUI TOWN, HUIYANG DISTRICT, HUIZHOU, GUANGDONG, CHINA

The following sample(s) was/were submitted and identified on behalf of the clients as : OSP

SGS Job No. : RP19-005089 - SZ  
Date of Sample Received : 22 Mar 2019  
Testing Period : 22 Mar 2019 - 30 Mar 2019  
Test Requested : Selected tests(s) as requested by client.  
Test Method : Please refer to next page(s).  
Test Results : Please refer to next page(s).

Conclusion : Based on the performed tests on submitted sample(s), the results of Lead, Mercury, Cadmium, Hexavalent chromium, Polybrominated biphenyls (PBBs), Polybrominated diphenyl ethers (PBDEs) and Phthalates such as Bis(2-ethylhexyl) phthalate (DEHP), Butyl benzyl phthalate (BBP), Dibutyl phthalate (DBP), and Diisobutyl phthalate (DIBP) comply with the limits as set by RoHS Directive (EU) 2015/863 amending Annex II to Directive 2011/65/EU.

Signed for and on behalf of  
SGS-CSTC Standards Technical Services Co., Ltd. Shenzhen Branch

*Tina*  
Tina Fan  
Approved Signatory



Unless otherwise agreed in writing, this document is issued by the Company subject to its General Conditions of Service printed on the reverse side of this document or available at <http://www.sgs.com>. The Client's attention is drawn to the limitation of liability, indemnification and jurisdiction issues defined therein. Any holder of this document is advised that information contained herein reflects the Company's findings at the time of its intervention only and within the limits of the Client's instructions. In any event, the Company's sole responsibility is to its Client and the document does not exonerate parties to a transaction from respecting all their rights and obligations under the transaction documents. This document cannot be reproduced or used in any manner whatsoever without the prior written approval of the Company. Any unauthorized alteration, forgery or falsification of the content or appearance of this document is unlawful and offenders may be prosecuted to the fullest extent of the law. Unless otherwise stated the validity shown in this report refers only to the samples tested.

Attention: To check the authenticity of testing SGS/CSTC Reports & certificates, please contact us at telephone: (86-755) 8307 1443 or e-mail: [CN.Certification@sgs.com](mailto:CN.Certification@sgs.com)

SGS 检测有限公司 深圳分公司 地址: 深圳市福田区福安路 518129 邮编: 518129 电话: (86-755) 25288888 / (86-755) 8307 1443  
SGS 检测有限公司 深圳分公司 地址: 深圳市福田区福安路 518129 邮编: 518129 电话: (86-755) 25288888 / (86-755) 8307 1443

Member of the SGS Group (SGS SA)



**Test Report** No. SZXEC1900530401 Date: 30 Mar 2019 Page 2 of 6

Test Results :

Test Part Description :

Specimen No.	SGS Sample ID	Description
SN1	SZX19-005304.001	Green"PCB"

- Remarks :
- (1) 1 mg/kg = 1 ppm = 0.0001%
  - (2) MDL = Method Detection Limit
  - (3) ND = Not Detected (< MDL)
  - (4) "-" = Not Regulated

RoHS Directive (EU) 2015/863 amending Annex II to Directive 2011/65/EU

Test Method : With reference to IEC 62321-4:2013+A1:2017, IEC62321-5:2013, IEC62321-7-2:2017, IEC 62321-6:2015 and IEC62321-8:2017, analyzed by ICP-OES, UV-Vis and GC-MS.

Test Item(s)	Limit	Unit	MDL	0/1
Cadmium (Cd)	100	mg/kg	2	ND
Lead (Pb)	1,000	mg/kg	2	8
Mercury (Hg)	1,000	mg/kg	2	ND
Hexavalent Chromium (Cr(VI))	1,000	mg/kg	8	ND
Sum of PBBs	1,000	mg/kg	-	ND
Monobromobiphenyl	-	mg/kg	5	ND
Dibromobiphenyl	-	mg/kg	5	ND
Tri bromobiphenyl	-	mg/kg	5	ND
Tetrabromobiphenyl	-	mg/kg	5	ND
Pentabromobiphenyl	-	mg/kg	5	ND
Hexabromobiphenyl	-	mg/kg	5	ND
Heptabromobiphenyl	-	mg/kg	5	ND
Octabromobiphenyl	-	mg/kg	5	ND
Nonabromobiphenyl	-	mg/kg	5	ND
Decabromobiphenyl	-	mg/kg	5	ND
Sum of PBDEs	1,000	mg/kg	-	ND
Monobromodiphenyl ether	-	mg/kg	5	ND
Dibromodiphenyl ether	-	mg/kg	5	ND
Tri bromodiphenyl ether	-	mg/kg	5	ND
Tetrabromodiphenyl ether	-	mg/kg	5	ND
Pentabromodiphenyl ether	-	mg/kg	5	ND



Unless otherwise agreed in writing, this document is issued by the Company subject to its General Conditions of Service printed on the reverse side of this document or available at <http://www.sgs.com>. The Client's attention is drawn to the limitation of liability, indemnification and jurisdiction issues defined therein. Any holder of this document is advised that information contained herein reflects the Company's findings at the time of its intervention only and within the limits of the Client's instructions. In any event, the Company's sole responsibility is to its Client and this document does not exonerate parties to a transaction from respecting all their rights and obligations under the transaction documents. This document cannot be reproduced or used in any manner whatsoever without the prior written approval of the Company. Any unauthorized alteration, forgery or falsification of the content or appearance of this document is unlawful and offenders may be prosecuted to the fullest extent of the law. Unless otherwise stated the validity shown in this report refers only to the samples tested.

Attention: To check the authenticity of testing SGS/CSTC Reports & certificates, please contact us at telephone: (86-755) 8307 1443 or e-mail: [CN.Certification@sgs.com](mailto:CN.Certification@sgs.com)

SGS 检测有限公司 深圳分公司 地址: 深圳市福田区福安路 518129 邮编: 518129 电话: (86-755) 25288888 / (86-755) 8307 1443  
SGS 检测有限公司 深圳分公司 地址: 深圳市福田区福安路 518129 邮编: 518129 电话: (86-755) 25288888 / (86-755) 8307 1443

Member of the SGS Group (SGS SA)





# ZPMV2.E490354 - WIRING, PRINTED - COMPONENT

## Wiring, Printed - Component

See General Information for Wiring, Printed - Component

**O-LEADING SUPPLY CHAIN (HK) CO LTD**  
 ROOM 1205, 12/F  
 TAI SANG BANK BLDG  
 130-132 DES VOEUS ROAD  
 CENTRAL, HONG KONG

E490354

Type	Cond Width		Cond Thk	SS/ DS/ DSO	Max	Max		Meets	C			
	Min	Edge			Area	Solder	Oper			Flame		
	mm(in)	mm(in)	mic(mil)		mm(in)	C	sec	C	Class	UL796	DSR	I
<b>Multilayer (mass laminate) printed wiring boards.</b>												
<b>O-LEADING-401</b>	0.1 (0.004)	0.3 (0.012)	34 (1.34)	DS	12.7 (0.5)	260	10	130	V-0	-	-	
<b>O-LEADING-407</b>	0.08 (0.003)	0.2 (0.008)	17 (0.67)	DS	9.7 (0.4)	260	10	130	V-0	All	-	
<b>Multilayer printed wiring boards.</b>												
<b>O-LEADING-408</b>	0.125 (0.005)	0.125 (0.005)	12 (0.47) Int:136	DS	50.8 (2.0)	280	20	130	V-0	All	*	
<b>Single layer printed wiring boards.</b>												
<b>O-LEADING-002</b>	0.38 (0.015)	1.14 (0.045)	34 (1.34)	SS	19.1 (0.8)	260	10	105	V-0	All	-	
<b>O-LEADING-003</b>	0.38 (0.015)	1.14 (0.045)	34 (1.34)	SS	19.1 (0.8)	260	10	130	V-0	▲	-	
<b>O-LEADING-033</b>	0.15 (0.006)	0.3 (0.012)	34 (1.34)	SS	25.4 (1.0)	260	10	120	V-0	All	-	
<b>O-LEADING-205</b>	0.1 (0.004)	0.3 (0.012)	34 (1.34)	DS	69.6 (2.7)	260	10	130	V-0	All	-	
<b>O-LEADING-206</b>	0.15 (0.006)	0.33 (0.013)	17 (0.67)	DS	69.6 (2.7)	260	10	130	V-0	All	-	
<b>O-LEADING-D01</b>	0.14 (0.006)	0.15 (0.006)	33 (1.30)	DS	25.4 (1.0)	260	10	130	V-0	All	*	
<b>O-LEADING-S01</b>	0.25 (0.010)	0.25 (0.010)	17 (0.67)	SS	25.4 (1.0)	260	4	130	V-0	All	*	

WIRING, PRINTED - COMPONENT | UL Product iQ

<b>O-LEADING-S02</b>	0.2 (0.008)	0.2 (0.008)	17 (0.67)	SS	25.4 (1.0)	260	4	130	HB	▲	*	
<b>O-LEADING-S03</b>	0.25 (0.010)	0.25 (0.010)	34 (1.34)	SS	25.4 (1.0)	260	4	130	V-0	All	*	

\* - CTI marking is optional and may be marked on the printed wiring board.

Marking: Company name or file number and type designation. May be followed by a suffix to denote factory identification or burning test classification.

并不是所有出现在本数据库中的公司名称和产品都满足了UL跟踪检验服务的要求。只有带有UL标志的产品，才应该被视为经过UL认证，并满足UL跟踪检验服务的要求。注意查看产品上的标志。

UL 允许在线认证目录中所含材料的复制遵循以下条件：1.指南信息、装配、构造、设计、系统和/或认证（文件）必须在不篡改任何数据（或图纸）的情况下完整且无误导性地呈现。2.经UL允许从在线认证目录转载“声明必须出现在所提取材料的邻近位置。此外，转载材料必须包含以下格式的版权声明：“© 2019 UL LLC”

# Capacità di processo

## Capacità di produzione di PCB

Conteggio strati	1Layer-32Layer
Spessore rame finito	1 / 3oz-12oz
Larghezza linea min / spaziatura interna	3.0mil / 3.0mil
Larghezza minima linea / spaziatura esterna	4.0mil / 4.0mil
Rapporto d'aspetto massimo	10: 1
Spessore del pannello	0,2 mm-5,0 mm
Dimensione massima del pannello (pollici)	635 * 1500 mm
Dimensione minima del foro praticato	4mil
Tolleranza foro placcato	+/- 3mil
Blind / Buried Vias (tipi All)	Sì
Tramite riempimento (conduttivo, non conduttivo)	Sì
Materiale di base	FR-4, FR-4 materiale privo di alogeni ad alta T, Rogers, base in alluminio, Polyimide, rame pesante
Finiture superficiali	HASL, OSP, ENIG, HAL-LF, Immersion silver, Immersion Latta, dita d'oro, inchiostro di carbone

## Capacità di produzione SMT

Materiale PCB	FR-4, CEM-1, CEM-3, scheda a base di alluminio
Dimensione massima PCB	510x460mm
Dimensioni minime PCB	50x50mm
Spessore PCB	0,5 mm-4,5 mm
Spessore del pannello	0,5-4 mm
Dimensioni minime dei componenti	0201
Componente di dimensioni standard del chip	0603 e versioni successive
Altezza max componente	15 mm
Passo minimo di piombo	0,3 mm
Min BGA palla pitch	0,4 mm
Precisione di posizionamento	+/- 0,03 mm

## Imballaggio e consegna

# Shipping service



Quick Turn Lead Time		
Layer Count:	Lead Tim	Special Requirement
1L/2L	2-3days	24 Hours,48 Hours
4L	3-4days	48 Hours
6L	4-5days	72 Hours
8L	5-6days	NA
10L	6-7days	NA
12L	7-8days	NA
14L	8-9days	NA

Standard Lead Time		
Layer Count:	Sample Lead Time	Volume order lead time
2L	4 days	10 days
4L	5 days	11 days
6L	6 days	12 days
8L	8 days	14 days
10L	10 days	16 days
12L	12 days	18 days
14L	14 days	20 days
16-32L	18 days	24 days

## FAQ

### 1. In che modo O-Leading garantisce la qualità?

Il nostro elevato standard di qualità si ottiene con quanto segue.

1.1 Il processo è rigorosamente controllato secondo gli standard ISO 9001: 2008.

1.2 Ampio utilizzo di software nella gestione del processo produttivo

1.3 Attrezzature e strumenti di prova all'avanguardia. Per esempio. Flying Probe, X-ray Inspection, AOI (Automated Optical Inspector) e ICT (in-circuit testing).

1.4. Team dedicato alla garanzia della qualità con processo di analisi dei casi di guasto

1.5 Formazione e istruzione continua del personale

### 2. In che modo O-Leading mantiene il prezzo competitivo?

Nell'ultimo decennio, i prezzi di molte materie prime (ad esempio rame, prodotti chimici) erano raddoppiati, triplicati o quadruplicati; La valuta cinese RMB si è apprezzata del 31% rispetto al dollaro USA; E anche il nostro costo del lavoro è aumentato in modo significativo.

Tuttavia, O-Leading ha mantenuto i nostri prezzi costanti. Ciò dipende interamente dalle nostre innovazioni nel ridurre i costi, evitare sprechi e migliorare l'efficienza. I nostri prezzi sono molto competitivi nel settore allo stesso livello di qualità.

Crediamo in una partnership vincente con i nostri clienti. La nostra partnership sarà reciprocamente vantaggiosa se possiamo fornirti un costo e una qualità eccezionali.



### **3. Che tipo di schede può elaborare O-Leading?**

FR4 comuni, schede ad alto TG e prive di alogeni, Rogers, Arlon, Telfon, schede a base di alluminio / rame, PI, ecc.

### **4. Quali dati sono necessari per la produzione di PCB e PCBA?**

4.1 BOM (distinta base) con designatori di riferimento: descrizione del componente, nome del produttore e numero di parte.

4.2 File Gerber PCB.

4.3 Disegno di fabbricazione del PCB e disegno di assemblaggio del PCBA.

4.4 Procedure di prova.

4.5 Eventuali limitazioni meccaniche come i requisiti di altezza di montaggio.

### **5. Qual è il flusso di processo tipico per PCB multistrato?**

Taglio del materiale → Film secco interno → Incisione interna → AOI interno → Multi-bond → Sovrapposizione di strati Pressatura → Foratura → PTH → Placcatura del pannello → Film secco esterno → Placcatura del modello → Incisione esterna → AOI esterno → Maschera di saldatura → Marchio del componente → Finitura superficiale → Instradamento → E / T → Ispezione visiva.

### **6. Quali sono le attrezzature chiave per la produzione HDI?**

L'elenco delle apparecchiature chiave è il seguente: perforatrice laser, pressatrice, linea VCP, macchina per esposizione automatica, LDI e così via.

Le attrezzature che abbiamo sono le migliori del settore, le macchine di perforazione laser provengono da Mitsubishi e Hitachi, le macchine LDI provengono da Screen (Giappone), le macchine per l'esposizione automatica sono anche da Hitachi, tutte fanno in modo che possiamo soddisfare i requisiti tecnici del cliente.

### **7. Quanti tipi di finitura superficiale O-lead può fare?**

O-the leader ha la serie completa di finiture superficiali, come: ENIG, OSP, LF-HASL, doratura (morbida / dura), argento per immersione, stagno, argentatura, stagnatura per immersione, inchiostro al carbonio e così via. OSP, ENIG, OSP + ENIG comunemente usati su HDI, di solito si consiglia di utilizzare un client o OSP OSP + ENIG se BGA PAD di dimensioni inferiori a 0,3 mm.

### **8. Qual è la tua capacità per FPC? O-Leading può fornire anche il servizio SMT?**

O-Leading può fabbricare FPC da un singolo strato a 8 strati, la dimensione del pannello di lavoro può arrivare fino a 2000 mm \* 240 mm, si prega di trovare i dettagli nella pagina "Capacità di flessibilità" Forniamo anche un servizio unico SMT al cliente.

### **9. Quali sono i principali fattori che influenzeranno il prezzo del PCB?**

Materiale;

Finitura superficiale;

Difficoltà tecnologica;

Diversi criteri di qualità;

Caratteristiche PCB;

Termini di pagamento;

Diversi paesi produttori.

### **10. Qual è la definizione di PCB, PWB e FPC e qual è la differenza?**

PCB è l'abbreviazione di Printed Circuit Board;

PWB è l'abbreviazione di Printed Wire Board, stesso significato di Printed Circuit Board;

FPC è l'abbreviazione di Flexible Printed Board.

### **11. Quali fattori dovrebbero essere considerati quando si sceglie il materiale per una scheda PCB?**

I seguenti fattori dovrebbero essere considerati quando scegliamo il materiale per PCB:

Il valore di Tg del materiale dovrebbe essere maggiore della temperatura di funzionamento;

Il materiale a basso CTE ha buone prestazioni di stabilità termica;

Buone prestazioni di resistenza termica: normalmente i PCB devono resistere a 250 °C per almeno 50 secondi.

Buona planarità; In considerazione delle proprietà elettriche, su PCB ad alta frequenza viene utilizzato materiale a bassa perdita / alta permittività; Substrato in fibra di vetro Polyimide utilizzato per PCB flessibile; L'anima in metallo viene utilizzata quando il prodotto ha requisiti rigorosi di dissipazione del calore.

### **12. Quali sono i vantaggi del PCB rigido flessibile di O-leading?**

Il PCB rigido-flessibile di O-leading ha i caratteri sia di FPC che di PCB, quindi può essere utilizzato in alcuni prodotti speciali. Una parte è flessibile mentre l'altra è rigida, può aiutare a risparmiare spazio interno del prodotto, ridurre il volume del prodotto e migliorare le prestazioni.

### **13. Come si effettua il calcolo dell'impedenza?**

Il sistema di controllo dell'impedenza viene eseguito utilizzando alcuni coupon di prova, il SI6000 soft e l'apparecchiatura CITS 500s di POLAR INSTRUMENTS.

L'apparecchiatura misura l'impedenza su un tagliando di configurazione del binario rappresentativo di cui il cliente ci ha fornito un determinato valore e tolleranza.