

Benvenuto in O-leading

O-Leading si impegna a essere il tuo partner unico nella catena di fornitura EMS, tra cui progettazione PCB, fabbricazione PCB e assemblaggio PCB (PCBA), forniamo alcune delle tecnologie PCB più avanzate, inclusi PCB HDI, PCB multistrato, PCB rigido-flessibili Siamo in grado di supportare dal prototipo a rotazione rapida alla produzione di massa e media. ([Fast Delivery Produttore di schede PCB a doppio lato](#))

In generale, i nostri clienti globali sono molto colpiti dai nostri servizi: risposta rapida, prezzo competitivo e impegno per la qualità. Fornire un servizio tecnico più prezioso e una soluzione globale è la strada che porta avanti.

Guardando al futuro, O-leading si concentrerà come sempre sull'innovazione e sullo sviluppo della tecnologia di produzione di componenti elettronici e farà sforzi persistenti sul servizio one-stop PCB e PCBA per fornire servizi di prima classe e creare più valore per i nostri clienti.

FARE CLIC SU QUESTI PER MAGGIORI INFORMAZIONI [Fabbrica di circuiti stampati con doppia placcatura in oro a doppio lato](#)

O-LEADING
To Be Reliable, To Be Valuable

WE ALWAYS PROVIDE YOU

BEST RIGID-FLEXIBLE CIRCUIT

WE ALWAYS PROVIDE YOU

BEST HIGH DENSITY INTERCONNECT PCB



Keep *LEARNING*

There's a phrase in Buddhism, 'Beginner's mind.'

It's wonderful to have a beginner's mind

WE HAVE A *DREAM*

Keep *RUNNING*

I would like to live to study and not study to live.

---Bacon



Descrizione del prodotto

Guangdong Circuit Board Fornitore produttore di schede PCB circuito stampato oem professionale, produttore di schede Pcb Pcb doppio lato Prezzo di fabbrica in oro duro 0,2 6 mm di spessore Hardware elettronico Circuito di placcatura

TOP QUALITY PCBA

O-LEADING
To Be Reliable, To Be Valuable

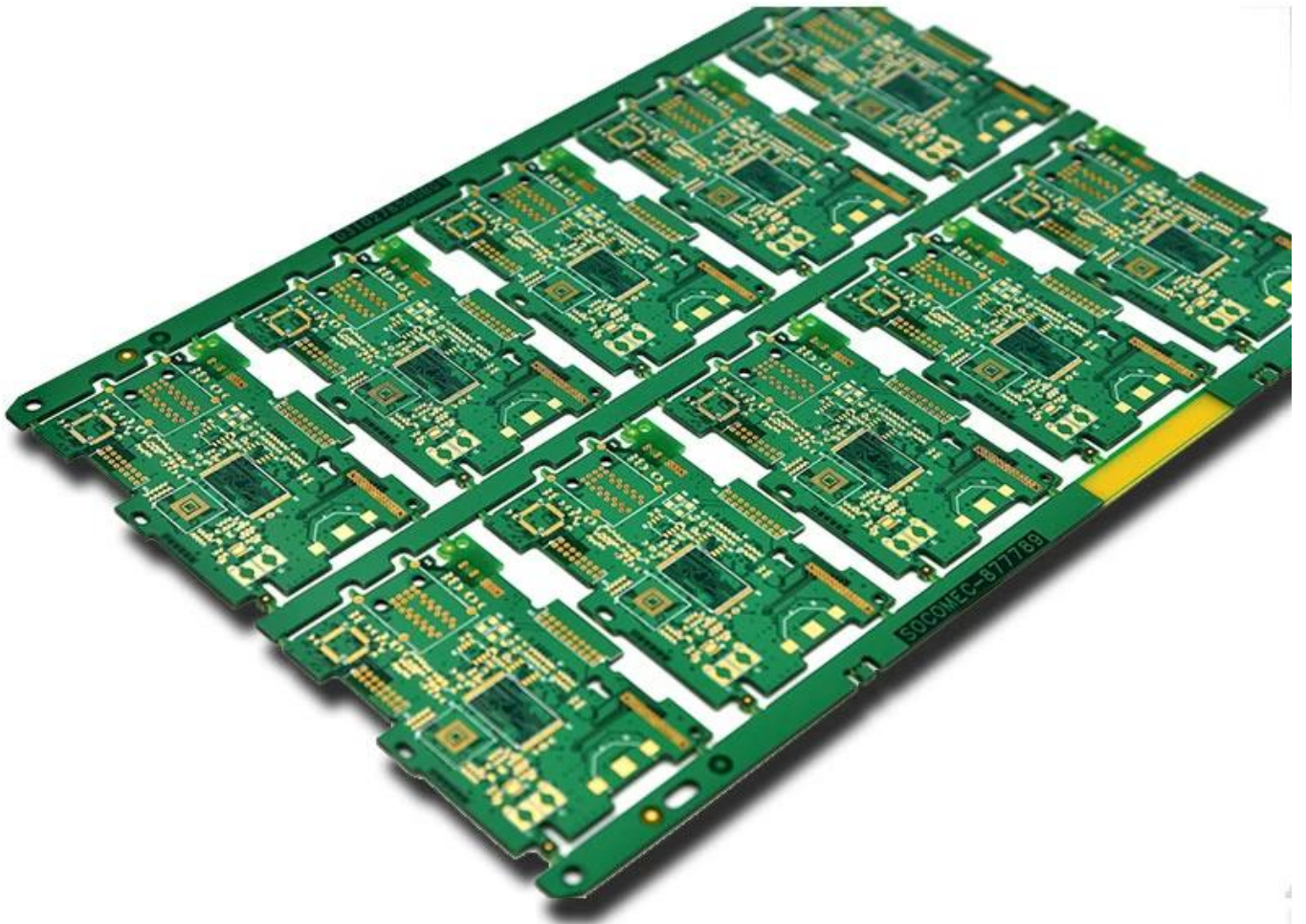

MAKE YOUR IDEA COME **TRUE**

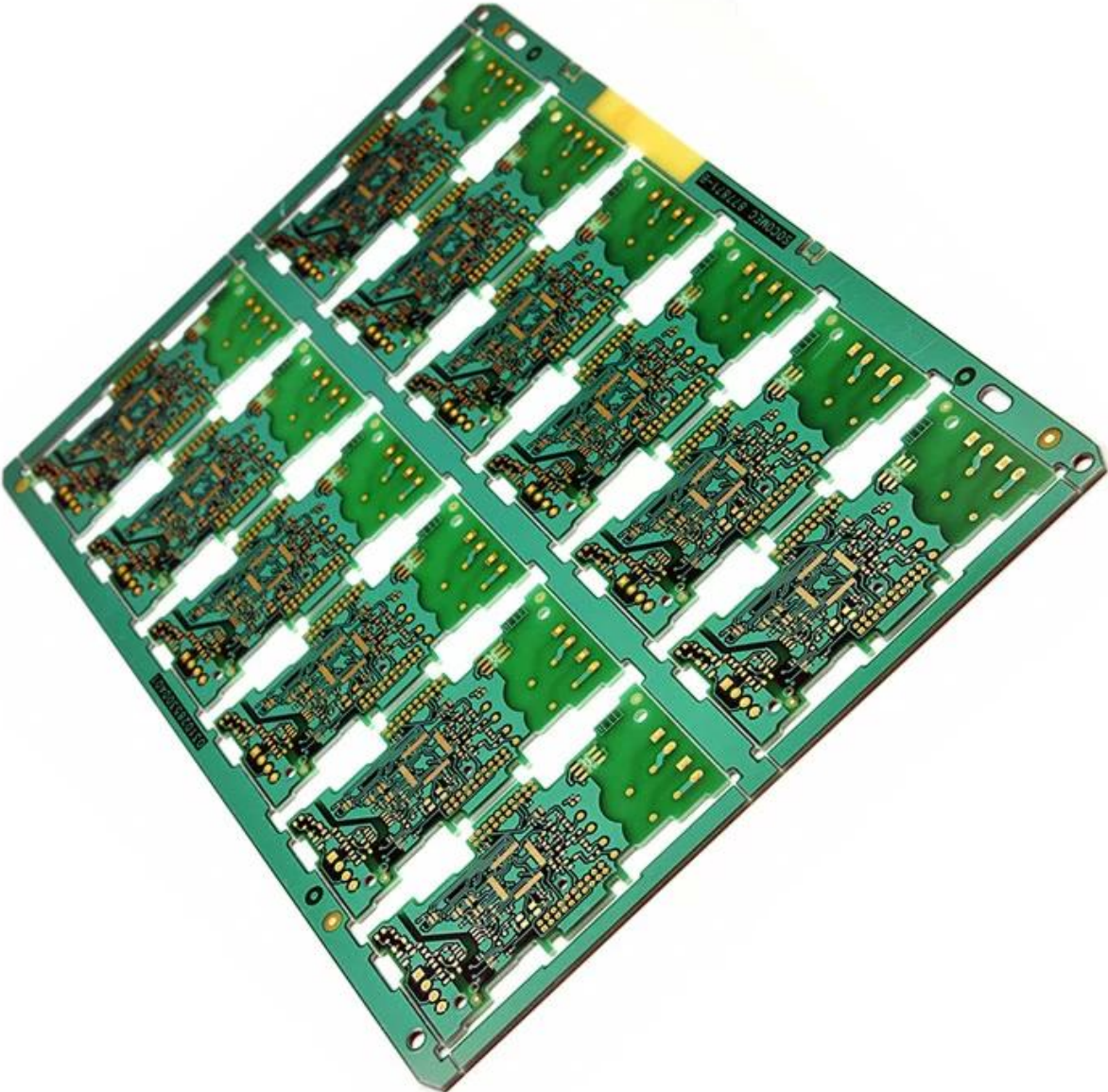

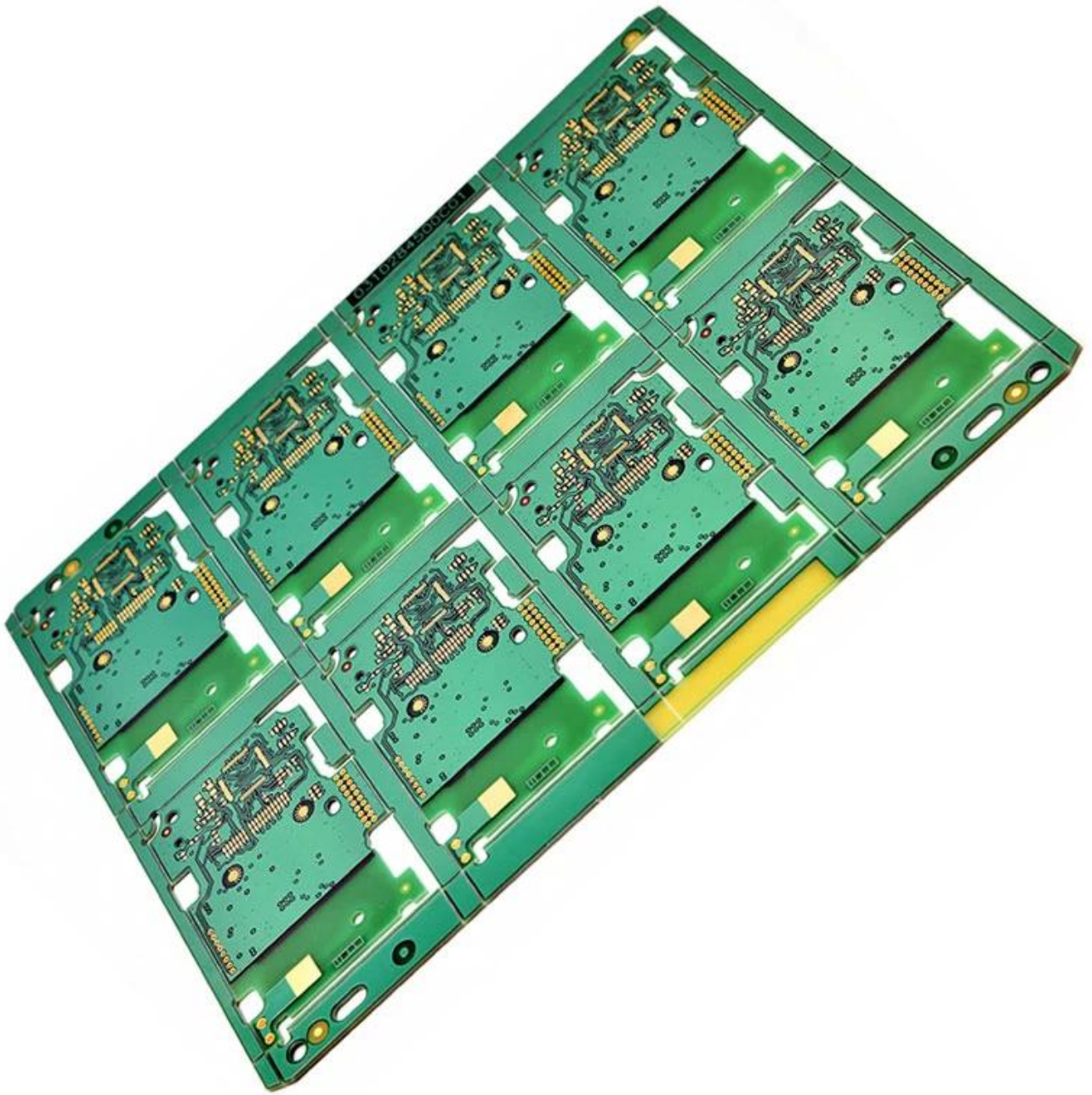

TOP QUALITY PCBA

O-LEADING

To Be Reliable, To Be Valuable



MAKE YOUR IDEA COME TRUE

TOP QUALITY PCBA

O-LEADING
To Be Reliable, To Be Valuable

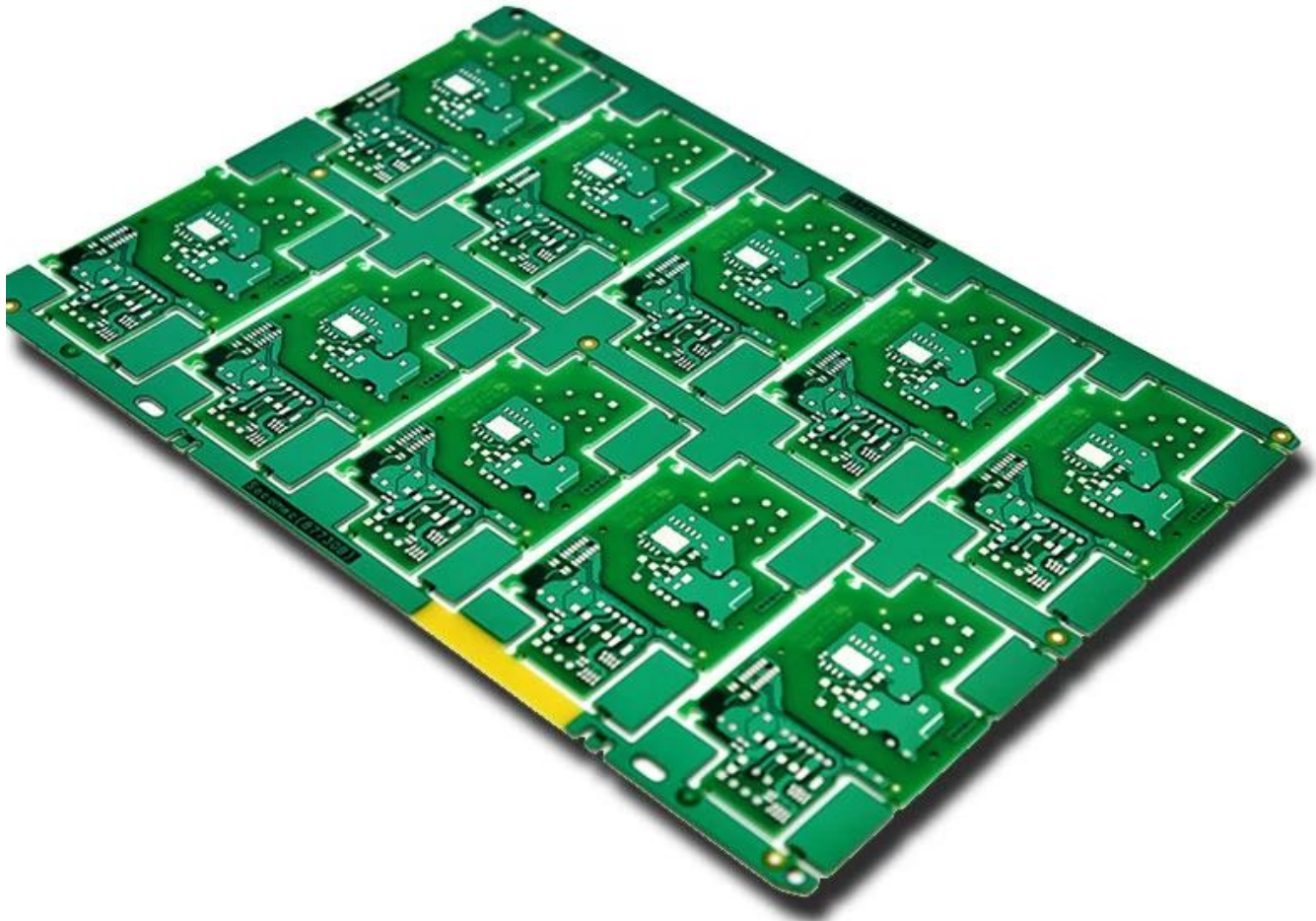

MAKE YOUR IDEA COME **TRUE**

TOP QUALITY PCBA

O-LEADING

To Be Reliable, To Be Valuable

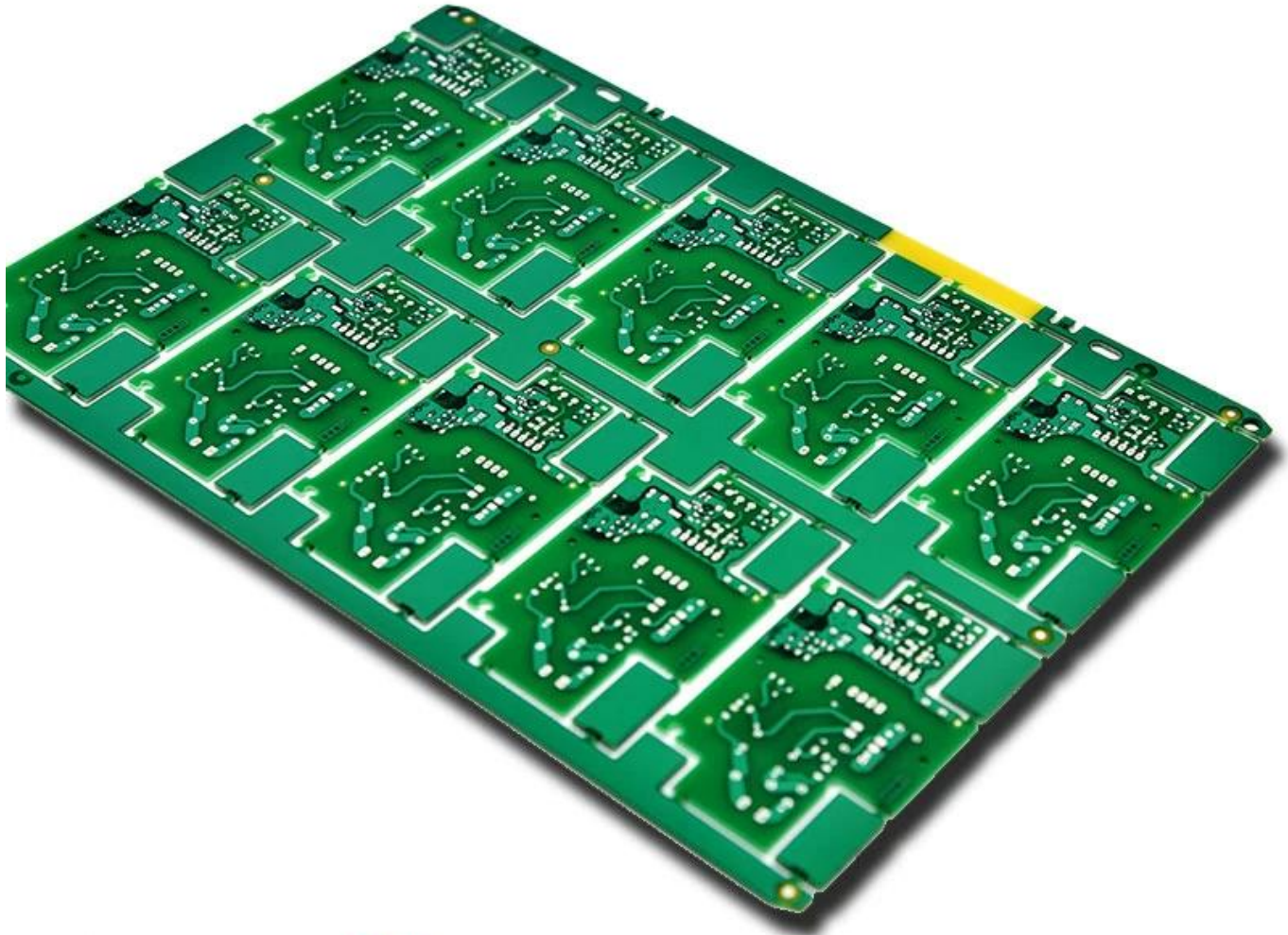

MAKE YOUR IDEA COME **TRUE**

Market Share

 CONSUMER ELECTRONICS

 AUTOMOTIVE ELECTRONICS

 INDUSTRIAL CONTROL

 INTELLECTUALIZED HOUSEHOLD CONTROL

 OTHER



30%
CONSUMER ELECTRONICS

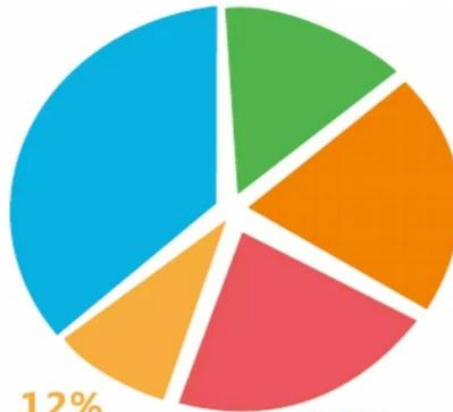

18%
INTELLECTUALIZED HOUSEHOLD CONTROL

20%
AUTOMOTIVE ELECTRONICS



12%
OTHER

20%
INDUSTRIAL CONTROL



Product types

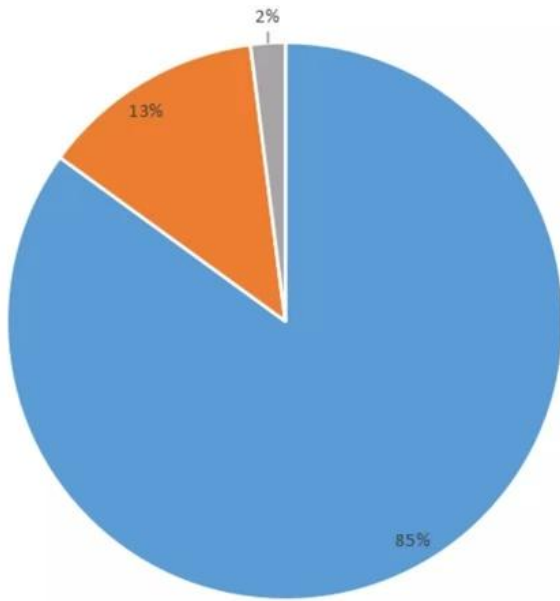

■ FR-4 PCB ■ MC PCB ■ rigid-flexible PCB

Product layers

■ 1L ■ 2L ■ 4L ■ 6L ■ >8L

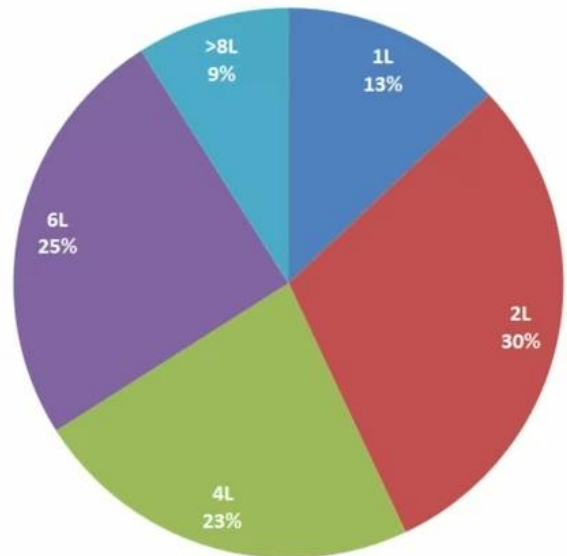

Production Process

18 years experience in one-stop PCB and PCBA, we can make your idea come true,



La nostra squadra



Factory PCB



Automatic vacuum press machine



Drilling Machine



Pattern Plating Machine



Scrubbing Machine



Developing Machine



Routing Machine



High-speed flying probe machine



E-test Machine

Factory SMT



HOW O-LEADING MAKE A PROJECT FOR YOU

Hardware Dispenser Application Not

O-LEADING
To be reliable, to be valuable

Automatic Dispenser Application Not

Voltage Table

Volt Pin Number	Description
VDD	Battery Voltage
+3V3	+3.3V
+5V	+5V
USB +5V	USB 5V input
+5V/2	Isolated +5V
+12V	12V DC Drive

STM32F072 PinOUT table

Wire Name	Description	DIO	Mode	Note
SM7N_TOF	Shutdown Time of flight sensor	Output	Logic '1' to shutdown	
I2C_SCL_TOF	I2C communication with time of flight sensor	I2C1_SCL		
I2C_SDA_TOF	I2C communication with thermopile sensor	I2C1_SDA		
I2C_SCL_IR	I2C communication with load cell control pins	I2C2_SCL		
I2C_SDA_IR		I2C2_SDA		
RATE_IC		Output		
DOUT_IC		Output		

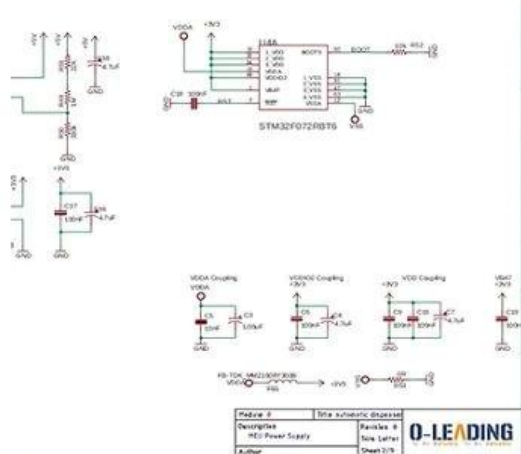

HARDWARE schematics

PCB PRODUCTION COMPONENTS SOURCING

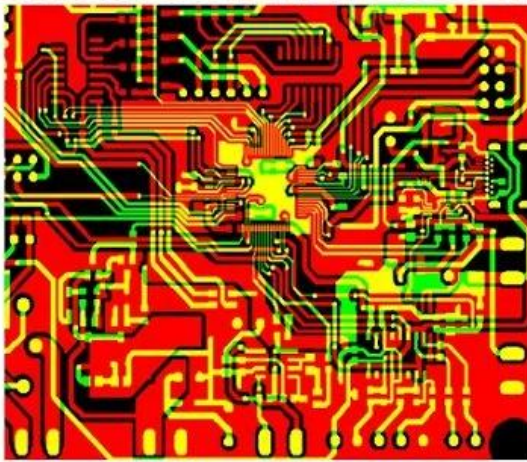

Qty	Value	Device	Parts	Description
4	AK500/1	AK500/2	X1, X2	CONNECTOR
1	AK500/1	AK500/3	X7	CONNECTOR
1	124114	MA04-2	SV2	
1	PPPC04	MA04-2	SV1	8 POS, 4*2 FEMALE PIN HEAD
1	ML10	ML10	SV4	HARTING
1	8MHZ	XTALL_CSTCE8M	X5	STCE8M00G52-R0 RESONATOR
1	0R	R-0603	R53	Thick Film Resistors - SMD 0603
2	10R	R-0603	R12, R5	Thick Film Resistors - SMD 0603
8	100R	R-0603	R1, R2	Thick Film Resistors - SMD 0603
1	270R	R-0805	R15	Thick Film Resistors - SMD 0605
1	330R	R-0603	R11	Thick Film Resistors - SMD 0603
9	680R	R-0603	R20, R3	Thick Film Resistors - SMD 0603
17	1k	R-0603	R9, R10	Thick Film Resistors - SMD 0603
2	4.7k	R-0603	R17, R6	Thick Film Resistors - SMD 0603
2	5.1k	R-0603	R18, R1	Thick Film Resistors - SMD 0603
9	10k	R-0603	R16, R3	Thick Film Resistors - SMD 0603

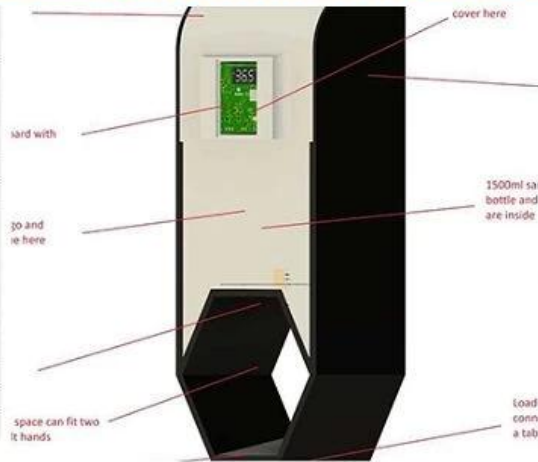
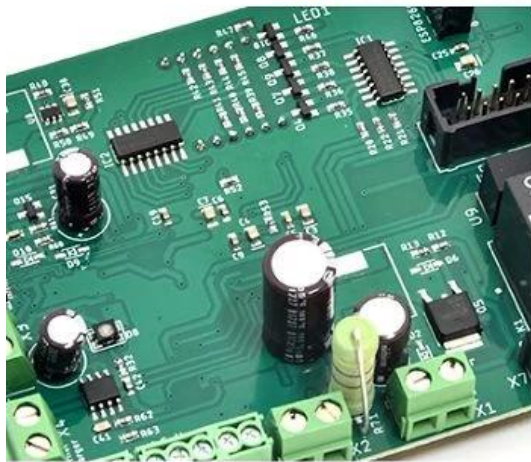

PCB Assembly MECHANICAL DESIGN

O-LEADING CUSTOMER

To be **RELIABLE**

- Q**uality first ,
- C**ustomer supreme ,
- S**cientifically management ,
- S**triving for famous brand



THE CUSTOMER IS KING

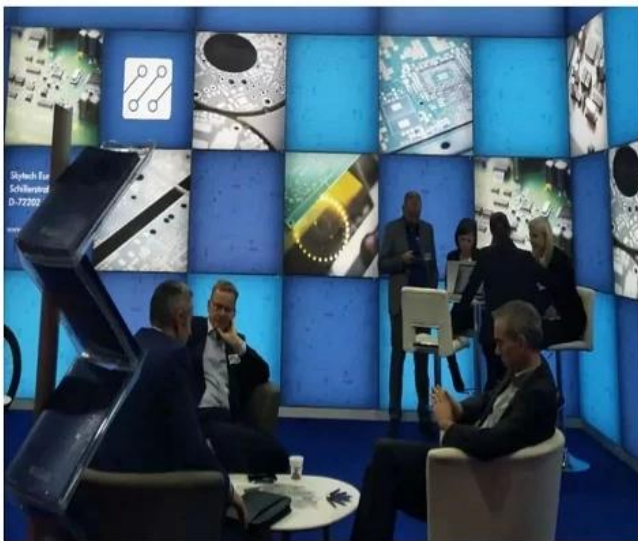

To be **VALUABLE**

- S**cience and technology keeps head ,
- P**ut people first ,
- B**e precise and practical ,
- C**ontribute sincerely

Skyworth 创维

HET 和而泰
HET INTELLIGENT CONTROL

dongweikeji
东威科技

美的 Midea

STAR-NET
星网锐捷

FORYOU
ADAYO 华阳集团

EDIFIER[®]

Cultraview 金锐显

3nod 三诺

T&W

TCL

AcBel 康舒科技
ACBEL POLYTECH INC.

Honeywell

Schneider
Electric

ZTE 中兴

EMERSON

BYD

PHILIPS

TE
connectivity

VIDEOTON

O-LEADING **CUSTOMER REVIEW**

CUSTOMER VOICE IS **EXTREMELY IMPORTANT TO US**

订单编号: 49335463501024670

供应商服务: 非常满意 (5 stars) 按时发货: 非常满意 (5 stars)



High quality usb power pcb , pcba manufacturer

★★★★★

Fancy has done an excellent job, whenever we write, she answered us within 1 second, O-leading is very perfect with fast delivery, fast logistics, the most important thing is good quality, good packaging, thank you!

[回复该评论](#)



oem customized rohs pcb drawing schematic s...

★★★★★

We received the boards, the quality is very good, the price is very reasonable, Fancy is very nice & smart & experienced, the logistics is super fast, I will come to see more in the future.

[回复该评论](#)

订单编号: 49298271001024670

供应商服务: 非常满意 (5 stars) 按时发货: 非常满意 (5 stars)



High TG180 FR-4 Circuit HDI PCB 94V0 Board ...

★★★★★

perfect product, perfect PCB supplier!

[回复该评论](#)



oem customized rohs pcb drawing schematic s...

★★★★★

Very good and professional PCB product as usual!

[回复该评论](#)



Strip LED Aluminum FR-4 lighting PCB board 9...

★★★★★

High quality, fast delivery, good service, competitive price, lucky and happy to purchase from O-leading!

[回复该评论](#)

订单编号: 49024962001024670

供应商服务: 非常满意 (5 stars) 按时发货: 非常满意 (5 stars)



High quality Keyboard pcb & pcba Factory SMT...

★★★★★

Top quality, it's the right choice to choose O-leading to make the PCB & PCBA

[回复该评论](#)

订单编号: 4093862201024670

供应商服务: 非常满意 (5 stars) 按时发货: 非常满意 (5 stars)



Professional Printed Circuit Board Manufactur...

★★★★★

Very high quality PCB products, O-leading is the best PCB supplier that we have ever worked with.

订单编号: 44068794501024670

供应商服务: 非常满意 (5 stars) 按时发货: 非常满意 (5 stars)



High TG180 FR-4 Circuit HDI PCB 94V0 Board ...

★★★★★

We bought two batches, one by DHL, the other one by air, good quality and fast delivery!

LISTEN TO **CUSTOMER VOICE**

订单编号: 40903347501024670

供应商服务: 非常满意 (5 stars) 按时发货: 非常满意 (5 stars)



Strip LED Aluminum FR-4 lighting PCB board 9...

★★★★★

Very fast delivery! Fantastic, good job!!!



Professional Printed Circuit Board Manufactur...

★★★★★

Very happy to great support from O-leading, they are not only professional on the PCB, but also provide good PCB products, very good supplier!



hot sale rigid-flexible PCB with 0.2mm BGA an...

★★★★★

very professional supplier



High Quality custom FPCB/Flex PCB/FPC/Flexi...

★★★★★

Good product



OEM ODM PCBA Bluetooth Wireless Marking G...

★★★★★

high soldering quality



Electronic parts haptic pcba Circuit Board asse...

★★★★★

Very Good product

订单编号: 37378603001024670

供应商服务: 非常满意 (5 stars) 按时发货: 非常满意 (5 stars)



Raspberry pi 0 Zero Raspberry Pi Zero P1 W ver...

★★★★★

Fantastic products!!!



double layer pcb with red S/M and LF-HASL su...

★★★★★

Good!

订单编号: 36919647001024670

供应商服务: 非常满意 (5 stars) 按时发货: 非常满意 (5 stars)



AML-S802 Quad-core Android embedded boar...

★★★★★

Good products



Fast delivery low cost pcb fabrication O-leadin...

★★★★★

Good supplier



Lidar IR Sensor board pcba(H08R6x)

★★★★★

perfect product



Customized PCBA design PCB design

★★★★★

perfect



Audio Speaker and Headphone Jack (H07R3x)

★★★★★

High quality, good



half hole pcb, half hole pcb module, half hole m...

★★★★★

Top half hole pcb supplier, very perfect goods



High Quality custom FPCB/Flex PCB/FPC/Flexi...

★★★★★

this rigid-flexible pcb quality is perfect!



Electronic parts haptic pcba Circuit Board asse...

★★★★★

Very satisfied with O-leading products and quality, especially their on-time delivery, fantastic!

Be **kind** to your client,
because he has many choices,
but he chooses you instead.

Certificazioni

CICC INSPECTION CERTIFICATION



嘉泰认证

QUALITY MANAGEMENT SYSTEM CERTIFICATE

Certificate No: 18118Q10347R05

We hereby certify that

O-LEADING SUPPLY CHAIN(HK) CO.,LIMITED

Credit No: 61691591-000-07-18-7

Registration Add: FLAT/RM 1205 12/F TAI SANG BANK BUILDING 130-132 DES VOEUS BOAD CENTRAL HK

Business Add: 1313, Floor 13, Fortune Building, Danshui Town, Huiyang District, Huizhou, Guangdong, China

Has implemented and maintains a **Quality Management System** Which fulfils the requirements of the following standards
GB/T19001-2016 idt ISO9001:2015

Scope of certification
Sales of printed circuit boards

Initial issuance period: February 27, 2018
Renewal date: April 22, 2019

This certificate is valid during: April 22, 2019 ~ February 26, 2021

This certificate is invalid without CICC qualified label in the following period

First supervision and audit	Second supervision and audit	Qualified mark
-----------------------------	------------------------------	----------------

The certification implementation scope does not include those production services which shall be obtained by the relevant effective administrative procedures and qualification procedures regulated by the state. The effectiveness of this certificate shall be notified by annual surveillance audits of CICC. The certificate shall be valid also only together with the surveillance audit certificate. The initial information of this certificate can be searched at the portal of CICC: www.cicc.com.cn. For the date of validity see above text.





CICC INSPECTION CERTIFICATION



嘉泰认证

质量管理体系认证证书

证书号: 18118Q10347R05

兹证明

诚领供应链(香港)有限公司

统一社会信用代码: 61691591-000-07-18-7

注册地址: 香港中環德輔道中 130-132 號大生銀行大廈 1205 室

经营地址: 广东惠州惠阳淡水南亨西路财富大厦 13 楼 1313

建立的质量管理体系符合

GB/T19001-2016 idt ISO9001:2015 质量标准适用条款的要求

认证范围
印刷线路板的销售

初次发证日期: 2018年02月27日



换证日期: 2019年04月22日

证书有效期: 自2019年04月22日至2021年02月26日

在下列期限内, 未经 CICC 黏贴合格标贴, 本证书无效

第一次监审	第二次监审	贴标处
-------	-------	-----

本证书认证范围不包括未获得有效的国家规定的行政许可、资质许可的产品/服务范围。本证书通过CICC定期监督审核保持, 与年度《保持认证通知书》共同方为有效。本证书信息可在国家认监委网站: www.cnca.gov.cn及CICC网站www.cicc.com.cn查询。





Test Report

No. SZXEC1900530401 Date: 30 Mar 2019 Page 1 of 6

O-LEADING SUPPLY CHAIN (HK) CO., LIMITED

1313.FLOOR 13, FORTUNE BUILDING, DANSHUI TOWN, HUIYANG DISTRICT, HUIZHOU, GUANGDONG, CHINA

The following sample(s) was/were submitted and identified on behalf of the clients as : OSP

SGS Job No. : RP19-005089 - SZ
Date of Sample Received : 22 Mar 2019
Testing Period : 22 Mar 2019 - 30 Mar 2019
Test Requested : Selected test(s) as requested by client.
Test Method : Please refer to next page(s).
Test Results : Please refer to next page(s).

Conclusion : Based on the performed tests on submitted sample(s), the results of Lead, Mercury, Cadmium, Hexavalent chromium, Polybrominated biphenyls (PBBs), Polybrominated diphenyl ethers (PBDEs) and Phthalates such as Bis(2-ethylhexyl) phthalate (DEHP) , Butyl benzyl phthalate (BBP), Dibutyl phthalate (DBP) , and Diisobutyl phthalate (DIBP) comply with the limits as set by RoHS Directive (EU) 2015/863 amending Annex II to Directive 2011/65/EU.

Signed for and on behalf of
SGS-CSTC Standards Technical Services Co., Ltd. Shenzhen Branch

Tina
Tina Fan
Approved Signatory



Unless otherwise agreed in writing, this document is issued by the Company subject to its General Conditions of Service printed overleaf, available on request or accessible at http://www.sgs.com/terms-and-conditions.aspx and, for electronic format documents, subject to Terms and Conditions for Electronic Documents at http://www.sgs.com/terms-and-conditions/Electronic-Document.aspx. Attention is drawn to the limitation of liability, indemnification and jurisdiction issues defined therein. Any holder of this document is advised that unless he/she expressly agrees to the Company's liability in the event of its interest only and within the limits of Client's instructions, it is the Company's sole responsibility to its Client and this document does not constitute a contract. In the absence of such express agreement, the Company's liability is limited to the extent of its responsibility for ensuring all test rights and obligations under the transaction documents. This document cannot be reproduced or used in any form without prior written approval of the Company. Any unauthorized alteration, forgery or falsification of the content or appearance of this document is unlawful and offenders may be prosecuted to the fullest extent of the law. Unless otherwise stated the results shown in this report refer only to the samples tested.

Member of the SGS Group (SGS SA)



Test Report

No. SZXEC1900530401 Date: 30 Mar 2019 Page 2 of 6

Test Results :

Test Part Description :

Table with 3 columns: Specimen No., SGS Sample ID, Description. Row 1: SN1, SZX19-005304.001, Green"PCB"

Remarks :

- (1) 1 mg/kg = 1 ppm = 0.0001%
(2) MDL = Method Detection Limit
(3) ND = Not Detected (< MDL)
(4) "-" = Not Regulated

RoHS Directive (EU) 2015/863 amending Annex II to Directive 2011/65/EU

Test Method : With reference to IEC 62321-4:2013+A1:2017, IEC 62321-5:2013, IEC 62321-7-2:2017, IEC 62321-6:2015 and IEC 62321-8:2017, analyzed by ICP-OES, UV-Vis and GC-MS.

Table with 5 columns: Test Item(s), Limit, Unit, MDL, 0/1. Lists various heavy metals and brominated compounds with their respective limits and detection results.



Unless otherwise agreed in writing, this document is issued by the Company subject to its General Conditions of Service printed overleaf, available on request or accessible at http://www.sgs.com/terms-and-conditions.aspx and, for electronic format documents, subject to Terms and Conditions for Electronic Documents at http://www.sgs.com/terms-and-conditions/Electronic-Document.aspx. Attention is drawn to the limitation of liability, indemnification and jurisdiction issues defined therein. Any holder of this document is advised that unless he/she expressly agrees to the Company's liability in the event of its interest only and within the limits of Client's instructions, it is the Company's sole responsibility to its Client and this document does not constitute a contract. In the absence of such express agreement, the Company's liability is limited to the extent of its responsibility for ensuring all test rights and obligations under the transaction documents. This document cannot be reproduced or used in any form without prior written approval of the Company. Any unauthorized alteration, forgery or falsification of the content or appearance of this document is unlawful and offenders may be prosecuted to the fullest extent of the law. Unless otherwise stated the results shown in this report refer only to the samples tested.

Member of the SGS Group (SGS SA)



ZPMV2.E490354 - WIRING, PRINTED - COMPONENT

Wiring, Printed - Component

See General Information for Wiring, Printed - Component

O-LEADING SUPPLY CHAIN (HK) CO LTD

E490354

ROOM 1205, 12/F
TAI SANG BANK BLDG
130-132 DES VOEUS ROAD
CENTRAL, HONG KONG

Type	Cond Width			SS/ DS/ DSO	Max	Max			Meets UL796	C T	
	Min	Cond	SS/ DS/ DSO		Area	Solder	Oper	Flame			
	mm(in)	Edge			Thk	Diam	Limits				Temp
	mm(in)	mm(in)	mic(mil)	DSO	mm(in)	C	sec	C	Class	DSR	I
Multilayer (mass laminate) printed wiring boards.											
O-LEADING-401	0.1 (0.004)	0.3 (0.012)	34 (1.34)	DS	12.7 (0.5)	260	10	130	V-0	-	-
O-LEADING-407	0.08 (0.003)	0.2 (0.008)	17 (0.67)	DS	9.7 (0.4)	260	10	130	V-0	All	-
Multilayer printed wiring boards.											
O-LEADING-408	0.125 (0.005)	0.125 (0.005)	12 (0.47) Int:136	DS	50.8 (2.0)	280	20	130	V-0	All	*
Single layer printed wiring boards.											
O-LEADING-002	0.38 (0.015)	1.14 (0.045)	34 (1.34)	SS	19.1 (0.8)	260	10	105	V-0	All	-
O-LEADING-003	0.38 (0.015)	1.14 (0.045)	34 (1.34)	SS	19.1 (0.8)	260	10	130	V-0	▲	-
O-LEADING-033	0.15 (0.006)	0.3 (0.012)	34 (1.34)	SS	25.4 (1.0)	260	10	120	V-0	All	-
O-LEADING-205	0.1 (0.004)	0.3 (0.012)	34 (1.34)	DS	69.6 (2.7)	260	10	130	V-0	All	-
O-LEADING-206	0.15 (0.006)	0.33 (0.013)	17 (0.67)	DS	69.6 (2.7)	260	10	130	V-0	All	-
O-LEADING-D01	0.14 (0.006)	0.15 (0.006)	33 (1.30)	DS	25.4 (1.0)	260	10	130	V-0	All	*
O-LEADING-S01	0.25 (0.010)	0.25 (0.010)	17 (0.67)	SS	25.4 (1.0)	260	4	130	V-0	All	*

WIRING, PRINTED - COMPONENT | UL Product iQ

O-LEADING-S02	0.2 (0.008)	0.2 (0.008)	17 (0.67)	SS	25.4 (1.0)	260	4	130	HB	▲	*
O-LEADING-S03	0.25 (0.010)	0.25 (0.010)	34 (1.34)	SS	25.4 (1.0)	260	4	130	V-0	All	*

* - CTI marking is optional and may be marked on the printed wiring board.

Marking: Company name or file number and type designation. May be followed by a suffix to denote factory identification or burning test classification.

并不是所有出现在本数据库中的公司名称和产品都满足了UL跟踪检验服务的要求。只有带有UL标志的产品，才应该被视为经过UL认证，并满足UL跟踪检验服务的要求。注意查看产品上的标志。

UL 允许在线认证目录中所含材料的复制遵循以下条件：1.指南信息、装配、构造、设计、系统和/或认证（文件）必须在不篡改任何数据（或图纸）的情况下完整且无误导性地呈现。2.经UL允许从在线认证目录转载“声明必须出现在所摘取材料的邻近位置。此外，转载材料必须包含以下格式的版权声明：“© 2019 UL LLC”

Capacità di processo

Capacità di produzione di PCB

Conteggio strati	1Layer-32Layer
Spessore rame finito	1 / 3oz-12oz
Larghezza linea min / spaziatura interna	3.0mil / 3.0mil
Larghezza minima linea / spaziatura esterna	4.0mil / 4.0mil
Rapporto d'aspetto massimo	10: 1
Spessore del pannello	0,2 mm-5,0 mm
Dimensione massima del pannello (pollici)	635 * 1500 mm
Dimensione minima del foro praticato	4mil
Tolleranza foro placcato	+/- 3mil
Blind / Buried Vias (tipi All)	Sì
Tramite riempimento (conduttivo, non conduttivo)	Sì
Materiale di base	FR-4, FR-4 materiale privo di alogeni ad alta T, Rogers, base in alluminio, Polyimide, rame pesante
Finiture superficiali	HASL, OSP, ENIG, HAL-LF, Immersion silver, Immersion Latta, dita d'oro, inchiostro di carbone

Capacità di produzione SMT

Materiale PCB	FR-4, CEM-1, CEM-3, scheda a base di alluminio, FPC
Dimensione massima PCB	510x1500mm
Dimensioni minime PCB	50x50mm
Spessore PCB	0,5 mm-4,5 mm
Spessore del pannello	0,5-4 mm
Dimensioni minime dei componenti	0201
Componente di dimensioni standard del chip	0603 e versioni successive
Altezza max componente	15 mm
Passo minimo di piombo	0,3 mm
Min BGA palla pitch	0,4 mm
Precisione di posizionamento	+/- 0,03 mm

Imballaggio e consegna

Shipping service



Quick Turn Lead Time		
Layer Count:	Lead Tim	Special Requirement
1L/2L	2-3days	24 Hours,48 Hours
4L	3-4days	48 Hours
6L	4-5days	72 Hours
8L	5-6days	NA
10L	6-7days	NA
12L	7-8days	NA
14L	8-9days	NA

Standard Lead Time		
Layer Count:	Sample Lead Time	Volume order lead time
2L	4 days	10 days
4L	5 days	11 days
6L	6 days	12 days
8L	8 days	14 days
10L	10 days	16 days
12L	12 days	18 days
14L	14 days	20 days
16-32L	18 days	24 days

FAQ

1. In che modo O-Leading garantisce la qualità? Il nostro standard di alta qualità si ottiene con quanto segue.

- 1.1 Il processo è rigorosamente controllato secondo gli standard ISO 9001: 2008.
- 1.2 Ampio utilizzo di software nella gestione del processo produttivo
- 1.3 Attrezzature e strumenti di prova all'avanguardia. Per esempio. Flying Probe, X-ray Inspection, AOI (Automated Optical Inspector) e ICT (in-circuit testing).
- 1.4. Team dedicato alla garanzia della qualità con processo di analisi dei casi di guasto
- 1.5 Formazione e istruzione continua del personale

2. In che modo O-Leading mantiene il prezzo competitivo?

Nell'ultimo decennio, i prezzi di molte materie prime (ad esempio rame, prodotti chimici) erano raddoppiati, triplicati o quadruplicati; La valuta cinese RMB si è apprezzata del 31% rispetto al dollaro USA; E anche il nostro costo del lavoro è aumentato in modo significativo.

Tuttavia, O-Leading ha mantenuto i nostri prezzi costanti. Ciò dipende interamente dalle nostre innovazioni nel ridurre i costi, evitare sprechi e migliorare l'efficienza. I nostri prezzi sono molto competitivi nel settore allo stesso livello di qualità.

Crediamo in una partnership vincente con i nostri clienti. La nostra partnership sarà reciprocamente

vantaggiosa se possiamo fornirti un costo e una qualità eccezionali.

3. Che tipo di schede può elaborare O-Leading?

FR4 comuni, schede ad alto TG e prive di alogeni, Rogers, Arlon, Telfon, schede a base di alluminio / rame, PI, ecc.

4. Quali dati sono necessari per la produzione di PCB e PCBA?

4.1 BOM (distinta base) con designatori di riferimento: descrizione del componente, nome del produttore e numero di parte.

4.2 File Gerber PCB.

4.3 Schema di fabbricazione PCB e schema di assemblaggio PCBA.

4.4 Procedure di prova.

4.5 Eventuali limitazioni meccaniche come i requisiti di altezza di montaggio.

5. Qual è il flusso di processo tipico per PCB multistrato?

Taglio del materiale → Film secco interno → Incisione interna → AOI interno → Multi-bond → Sovrapposizione di strati Pressatura → Foratura → PTH → Placcatura del pannello → Film secco esterno → Placcatura del modello → Incisione esterna → AOI esterno → Maschera di saldatura → Marchio del componente → Finitura superficiale → Instradamento → E / T → Ispezione visiva.

6. Quali sono le attrezzature chiave per la produzione HDI?

L'elenco delle apparecchiature chiave è il seguente: trapano laser, pressa, linea VCP, macchina per esposizione automatica, LDI e così via. Le attrezzature che abbiamo sono le migliori del settore, le perforatrici laser sono Mitsubishi e Hitachi, le macchine LDI provengono da Screen (Giappone), anche le macchine per l'esposizione automatica sono Hitachi, tutte ci consentono di soddisfare i requisiti tecnici del cliente.

7. Quanti tipi di finitura superficiale O-lead può fare?

O-the leader ha la serie completa di finiture superficiali, come: ENIG, OSP, LF-HASL, doratura (morbida / dura), argento per immersione, stagno, argentatura, stagnatura per immersione, inchiostro al carbonio e così via. OSP, ENIG, OSP + ENIG comunemente usati su HDI, di solito si consiglia di utilizzare un client o OSP OSP + ENIG se BGA PAD di dimensioni inferiori a 0,3 mm.

8. Qual è la tua capacità per FPC? O-Leading può fornire anche il servizio SMT?

O-Leading può fabbricare FPC da un singolo strato a 8 strati, la dimensione del pannello di lavoro può arrivare fino a 2000mm * 240mm, si prega di trovare i dettagli nella pagina "Flex Capability". Forniamo anche un servizio unico SMT al cliente.

9. Quali sono i principali fattori che influenzeranno il prezzo del PCB?

Materiale;

Finitura superficiale;

Difficoltà tecnologica;

Diversi criteri di qualità;

Caratteristiche PCB;

Termini di pagamento;

Diversi paesi produttori.

10. Qual è la definizione di PCB, PWB e FPC e qual è la differenza?

PCB è l'abbreviazione di Printed Circuit Board;

PWB è l'abbreviazione di Printed Wire Board, stesso significato di Printed Circuit Board;

FPC è l'abbreviazione di Flexible Printed Board.

11. Quali fattori dovrebbero essere considerati quando si sceglie il materiale per una scheda

PCB?

I seguenti fattori dovrebbero essere considerati quando scegliamo il materiale per PCB:

Il valore di Tg del materiale dovrebbe essere maggiore della temperatura di funzionamento;

Il materiale a basso CTE ha buone prestazioni di stabilità termica;

Buone prestazioni di resistenza termica: normalmente i PCB devono resistere a 250 °C per almeno 50 secondi.

Buona planarità; In considerazione delle proprietà elettriche, su PCB ad alta frequenza viene utilizzato materiale a bassa perdita / alta permittività;

Substrato in fibra di vetro di poliimmide utilizzato per PCB flessibile; L'anima in metallo viene utilizzata quando il prodotto ha requisiti rigorosi di calore dissipazione.

12. Quali sono i vantaggi del PCB rigido flessibile di O-leading?

Il PCB rigido-flessibile di O-leading ha i caratteri sia di FPC che di PCB, quindi può essere utilizzato in alcuni prodotti speciali. Una parte è flessibile mentre l'altra è rigida, può aiutare a risparmiare spazio interno del prodotto, ridurre il volume del prodotto e migliorare le prestazioni.

13. Come si effettua il calcolo dell'impedenza?

Il sistema di controllo dell'impedenza viene eseguito utilizzando alcuni coupon di prova, il SI6000 soft e l'apparecchiatura CITS 500s di POLAR INSTRUMENTS. L'apparecchiatura misura l'impedenza su un tagliando di configurazione del binario rappresentativo di cui il cliente ci ha fornito un determinato valore e tolleranza.