

# Benvenuti in O-Leader

O-leader si impegna ad essere il tuo partner Solution One Stop nella catena di approvvigionamento EMS, incluso il design PCB, la fabbricazione di PCB e il gruppo PCB, forniamo alcune delle tecnologie PCB più avanzate, tra cui PCB più avanzate, inclusi PCBS HDI, PCB multistrato, PCBS flessibile rigido. Supporto dal prototipo di ruota rapida a media e produzione di massa.

In generale, i nostri clienti globali sono molto impressionati dai nostri servizi: risposta rapida, prezzo competitivo e impegno di qualità. Provare un servizio tecnico più prezioso e una soluzione generale è il modo in cui O-guida in avanti.

Guardando al futuro, O-leader si concentrerà sull'innovazione e lo sviluppo della tecnologia di produzione dell'elettronica come sempre e rendono sempre sforzi persistenti sul servizio PCB e PCBA one-stop per fornire servizi di prima classe e creare più valore per i nostri clienti.

Si prega di fare clic su questi per ulteriori informazioni: [P.Fornitore di PCB flessibile rigido professionale per custodia Raspberry PI 4 ABS](#)

**O-LEADING**  
To Be Reliable, To Be Valuable

WE ALWAYS PROVIDE YOU

**BEST HIGH DENSITY INTERCONNECT PCB**

WE ALWAYS PROVIDE YOU

**BEST RIGID-FLEXIBLE CIRCUIT**

## Descrizione del prodotto

Alphabot2 wireless video smart robot alimentato da Raspberry PI 4 con PI4B-4GB

Industrie applicabili: impianti di produzione, aziende agricole, negozi di bevande, altro

Località showroom: nessuno

Nome del prodotto: robot intelligente

Utilizzo: elettronica OEM

Certificato: Rosh. ISO9001.

Maschera di saldatura: verde. Rosso. Blu. Bianca. Nero giallo

Servizio: un servizio tacchino one stop

Caratteristiche: processore quad-core, LAN wireless a doppia banda, Bluetooth 4.2 / ble

## Raspberry Pi 4 Video Robot With PI4B

AlphaBot2 Wireless Video Smart Robot

Obstacle Avoidance, Line Tracking, Wireless Remote Control, Video Monitoring...



\* The Raspberry Pi 4 is optional, up to your choice.

# Raspberry Pi 4 Completely Upgraded

More Powerful Processor, Richer Multi-Media Capability, Faster Networking

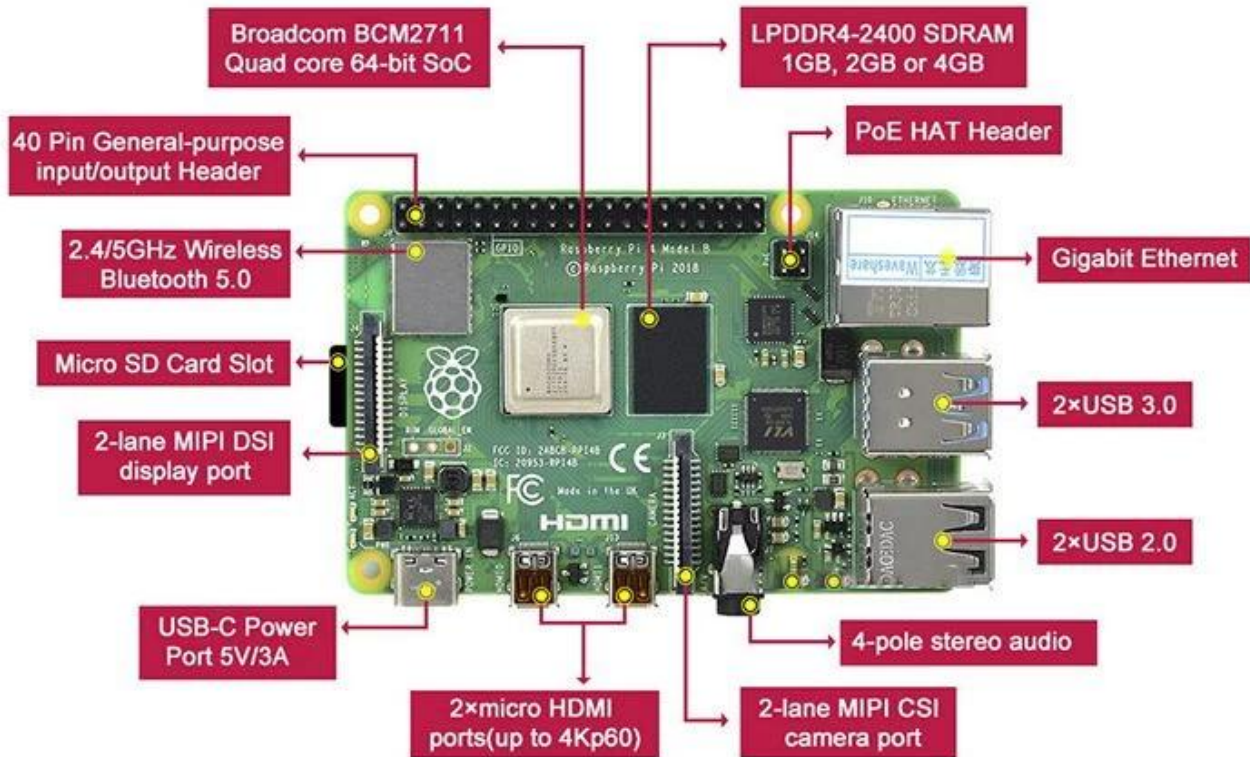

<b>BCM2711B0</b> 64-bit 1.5GHz Quad-core Processor	<b>Choice Of RAM</b> 2GB / 4GB / 8GB	<b>4K Dual HDMI</b> 4K High Resolution Dual Displays
<b>Faster Networking</b> Gigabit ETH, Bluetooth 5.0, Dual-band WiFi	<b>New USB3.0</b> 2xUSB3.0 + 2xUSB2.0	<b>USB-C Power</b> Upgraded Power Supply, More Powerful

# Versatile AlphaBot2 Chassis

Compatible With Multi Controllers Via Related Adapter Boards (Purchased Separately)

Easily Turn It Into A Pi Zero / Arduino Robot

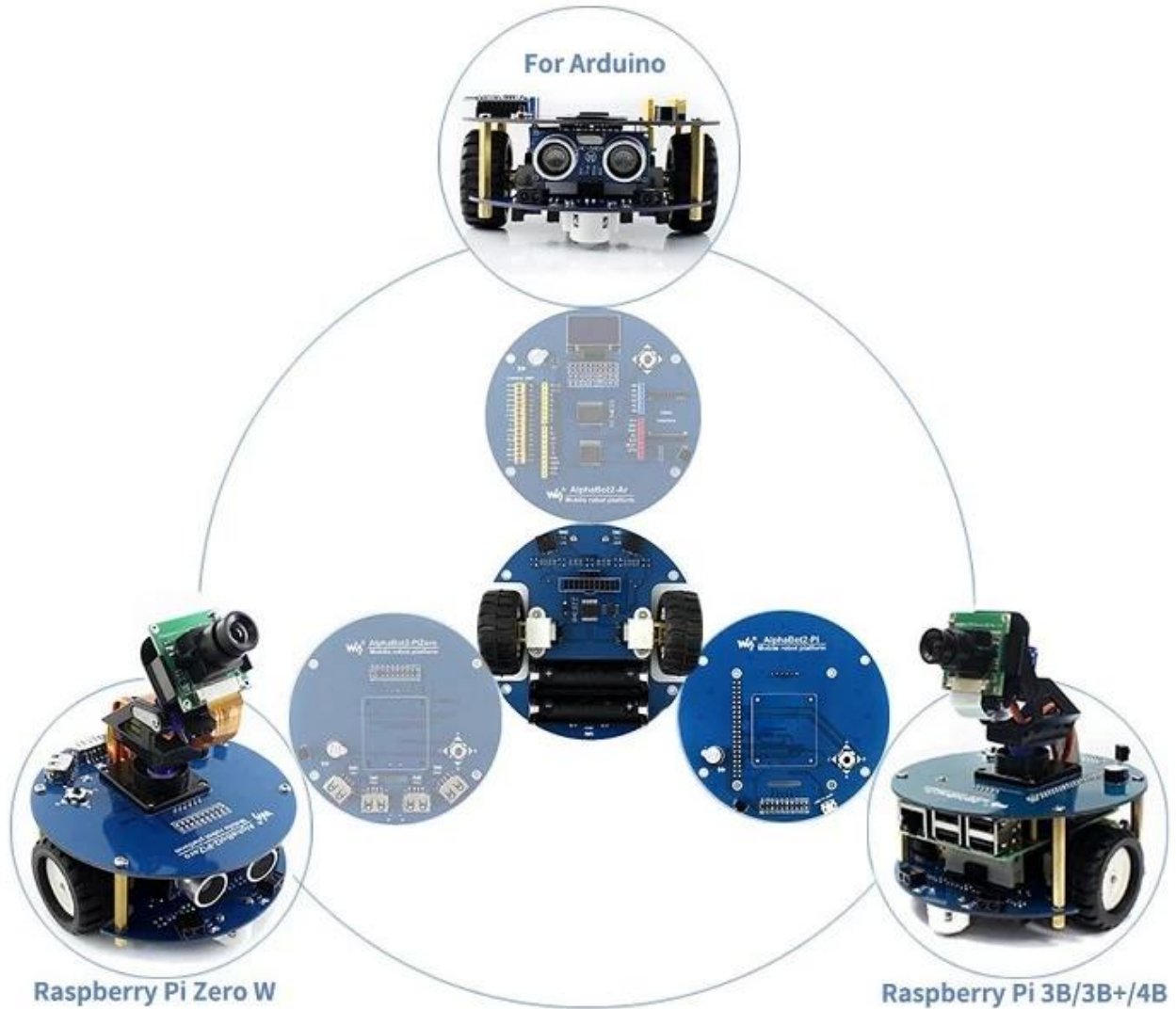

# Modular Design, No More Messy Wiring

Highly Integrated AlphaBot2-Pi Adapter Board:

IR Obstacle Avoidance, 5-Ch Detector Li Tracking, Battery Charging Circuit, High Quality N20 Motor, Rubber Wheels, And Colorful RGB LED



# Raspberry Pi 5MP HD Camera, 1080P

The Leading Role For Vision Applications, Like Mjpg-Streamer Video Monitoring, And OpenCV Intelligent Recognition Driving



# Full Functionality, Common Examples

For More Possibilities, Refer To Example Code And Manual

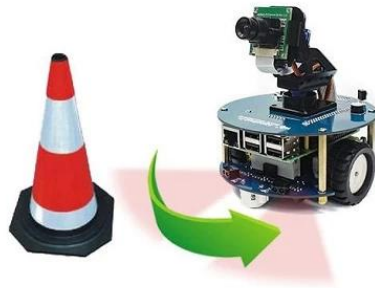

## Obstacle Avoidance

The module sends IR beam and detects objects by receiving the reflected IR beam, to easily avoid obstacles in the way.

## Auto Line Tracking

Features 5-ch IR detector for sensing and analysing the black line, combined with PID algorithm for adjusting robot movement, high sensitivity, stable tracking.

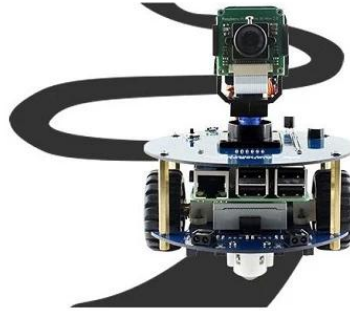

## Bluetooth Control

Provides mobile APP to control the robot movement and peripherals, such as RGB LED color, onboard buzzer, etc.

## Infrared Control

With the IR receiver onboard, it is allowed to control the robot via IR remote controller, make it move forward or change direction...



Web control (Mobile/Tablet/PC)    Qt software control (PC)    APP control (Android phone)



## WiFi Control

Supports WiFi remote control, real time video monitoring via webpage / APP / PC, also features routing function by creating WiFi hotspot.

## 2-DOF Pan-Tilt

2-DOF pan and tilt + hardware PWM controlled servo, smoothly rotates the camera to capture omnibearing images.

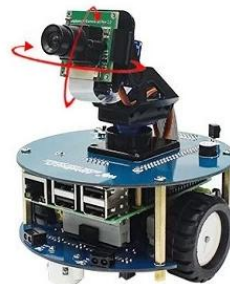



AlphaBot2-Pi robot RGB LED control



AlphaBot2-Pi robot video monitoring



AlphaBot2-Pi robot Bluetooth control

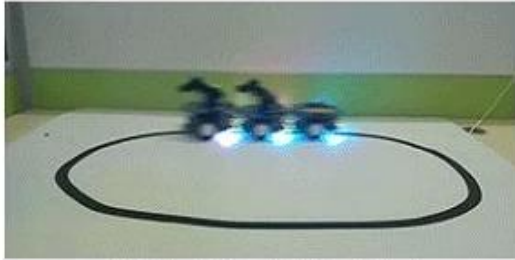

multi AlphaBot2 robots line following



AlphaBot2-Pi robot obstacle avoiding



# Kits Selection Guide

Various Raspberry Pi 4 Kits Are Available, Find Your Favorite One

## Starter Kit

The very essential parts to get started, guaranteed compatibility and stability.

- 16GB Class10 high speed micro SD card
- 5V 3A Type-C power supply
- Cool brass heat sink
- Extra free micro SD card reader



## Display Kit

Build your own all-in-one computer powered by Raspberry Pi 4, much more funny.

- 7inch wide viewing angle HD touch screen
- High quality black/white acrylic protective case
- HDMI to micro HDMI cable
- 16GB micro SD card, power supply...

## Sensor Kit Pi x Arduino

Sensors are important parts of IoT, while the Arduino is a massive ecosystem, this kit provides a way for the Pi to make use of these powerful things.

1 + 1 > 2

- Pi to Arduino adapter board
- 13x popular sensors
- 16GB micro SD card, power supply...



## Robot Kit AlphaBot

Make a Raspberry Pi smart mobile robot, easily use it for obstacle avoidance, line tracking, Bluetooth / IR / WiFi remote control, or video monitoring. Arduino compatible.

- AlphaBot driver board
- AlphaBot chassis
- Modules: Camera / Line tracking / Speed measuring...
- Raspberry Pi 4 is NOT included

## Robot Kit AlphaBot2

Make a Raspberry Pi smart mobile robot, easily use it for obstacle avoidance, line tracking, Bluetooth / IR / WiFi remote control, or video monitoring. A smaller and more flexible one.

- AlphaBot2-Pi (adapter board)
- AlphaBot2-Base (base chassis)
- Modules: Camera...



## Robot Arm Kit

Flexible and stable 4-DOF metal robot arm, allows to be controlled by smart phone through Bluetooth or WiFi connection.

"Just grab it"

- Servo driver board
- Metal mechanical arm structure
- 4x servos, power supply...
- Raspberry Pi 4 is NOT included

# La nostra squadra

O-LEADING *CUSTOMER*

To be *RELIABLE*

- Quality first ,
- Customer supreme ,
- Scientifically management ,
- Striving for famous brand



*THE CUSTOMER IS KING*

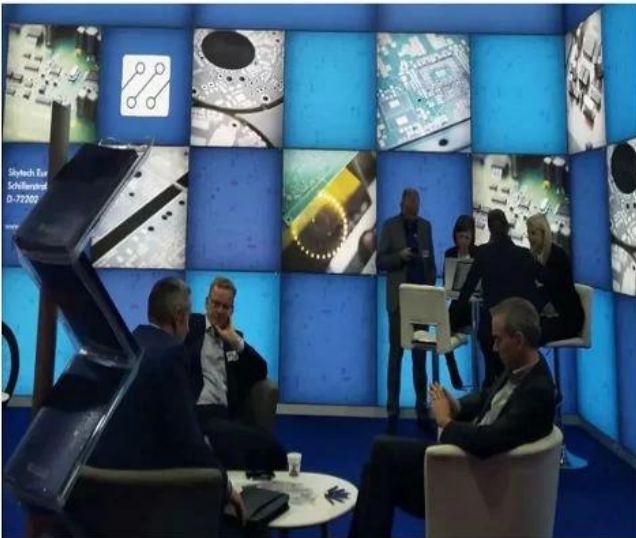

To be *VALUABLE*

- Science and technology keeps head ,
- Put people first,
- Be precise and practical,
- contribute sincerely

---

Factory PCB

---



Automatic vacuum press machine



Drilling Machine



Pattern Plating Machine



Scrubbing Machine



Developing Machine



Routing Machine



High-speed flying probe machine



E-test Machine

---

Factory SMT

---



# HOW O-LEADING MAKE A PROJECT FOR YOU

Hardware Dispenser Application Not

## Automatic Dispenser Application Not

Voltage Table

Volt Pin Number	Description
VDD	Battery voltage
+3V3	+3.3V
+5V	+5V
USB +5V	USB 5V input
+5V/2	Isolated +5V
+12V	12V DC Drive

STM32F072 PINOUT table

Wire Name	Description	DIO	Mode	Note
SMTN_TOF	Shutdown Time of flight sensor	Output	Logic '0' to shutdown	
I2C_SCL_TOF	I2C communication with time of flight sensor	I2C1_SCL		
I2C_SDA_TOF	I2C communication with thermopile sensor	I2C1_SDA		
I2C_SCL_IR	I2C communication with thermopile sensor	I2C2_SCL		
I2C_SDA_IR	I2C communication with thermopile sensor	I2C2_SDA		
RATE_LC	Load cell control pins	Output		
DOUT_LC	Load cell control pins	Output		

**O-LEADING**  
TO BE RELIABLE, TO BE AVAILABLE

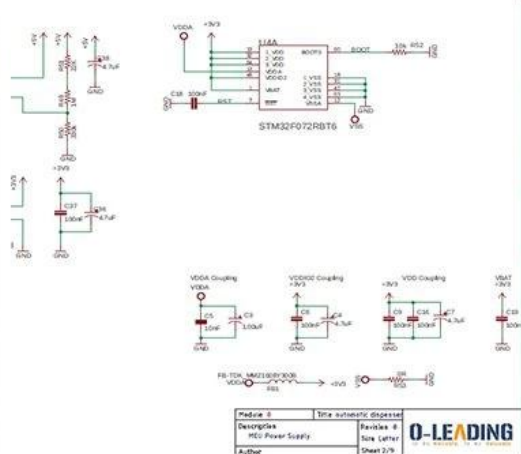

## HARDWARE schematics

## PCB PRODUCTION COMPONENTS SOURCING

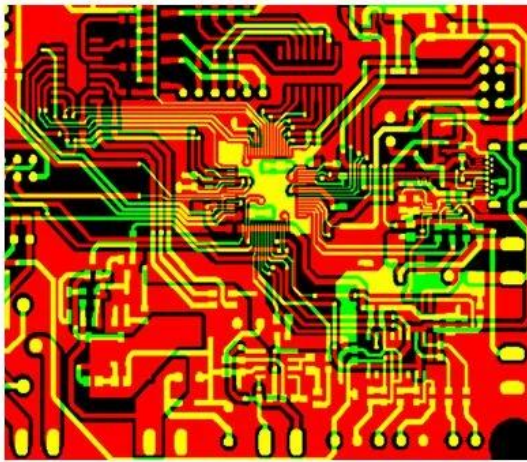

Qty	Value	Device	Parts	Description
4	AK500/2	AK500/2	X1, X2	CONNECTOR
1	AK500/3	AK500/3	X7	CONNECTOR
1	1241148	MA04-2	SV2	
1	PPPC04	MA04-2	SV1	8 POS, 4*2 FEMALE PIN HEAD
1	ML10	ML10	SV4	HARTING
1	8MHZ	XTALL_CSTCE8M	X5	STCE8M00G52-R0 RESONATOR
1	0R	R-0603	R53	Thick Film Resistors - SMD 0603
2	10R	R-0603	R12, R5	Thick Film Resistors - SMD 0603
8	100R	R-0603	R1, R2	Thick Film Resistors - SMD 0603
1	270R	R-0805	R15	Thick Film Resistors - SMD 0605
1	330R	R-0603	R11	Thick Film Resistors - SMD 0603
9	680R	R-0603	R20, R3	Thick Film Resistors - SMD 0603
17	1k	R-0603	R9, R10	Thick Film Resistors - SMD 0603
2	4.7k	R-0603	R17, R6	Thick Film Resistors - SMD 0603
2	5.1k	R-0603	R18, R1	Thick Film Resistors - SMD 0603
9	10k	R-0603	R16, R3	Thick Film Resistors - SMD 0603

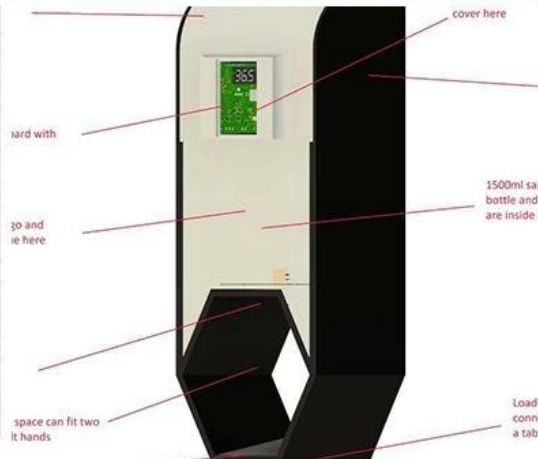

## PCB Assembly MECHANICAL DESIGN

Skyworth 创维

**HET** 和而泰  
HET INTELLIGENT CONTROL

dongweikeji  
东威科技

美的 Midea

STAR-NET  
星网锐捷

FORYOU  
ADAYO 华阳集团

**EDIFIER**<sup>®</sup>

Cultraview 金锐显

3nod 三诺

**T&W**

**TCL**

AcBel 康舒科技  
ACBEL POLYTECH INC.

**Honeywell**

Schneider  
Electric

**ZTE** 中兴

**EMERSON**

**BYD**

**PHILIPS**

**TE**  
connectivity

**VIDEOTON**

CUSTOMER VOICE IS EXTREMELY IMPORTANT TO US

订单编号: 49335463501024670

供应商服务: 非常满意 (5 stars) 按时发货: 非常满意 (5 stars)



**High quality usb power pcb , pcba manufacturer**

★★★★★

Fancy has done an excellent job, whenever we write, she answered us within 1 second, O-leading is very perfect with fast delivery, fast logistics, the most important thing is good quality, good packaging, thank you!

[回复该评论](#)



**oem customized rohs pcb drawing schematic s...**

★★★★★

We received the boards, the quality is very good, the price is very reasonable, Fancy is very nice & smart & experienced, the logistics is super fast, I will come to see more in the future.

[回复该评论](#)

订单编号: 4932411001024670

供应商服务: 非常满意 (5 stars) 按时发货: 非常满意 (5 stars)



**High TG180 FR-4 Circuit HDI PCB 94V0 Board...**

★★★★★

This is a very difficult PCB design, but we are lucky to find O-leading to support the PCB for us very good to a PCB supplier.



**universal FR4 Multilayer PCB washing machine...**

★★★★★

Fancy gives us very excellent service, very professional and experienced, O-leading is the best one of our suppliers, very happy to work with them.

订单编号: 49298271001024670

供应商服务: 非常满意 (5 stars) 按时发货: 非常满意 (5 stars)



**High TG180 FR-4 Circuit HDI PCB 94V0 Board ...**

★★★★★

perfect product, perfect PCB supplier!

[回复该评论](#)



**oem customized rohs pcb drawing schematic s...**

★★★★★

Very good and professional PCB product as usual!

[回复该评论](#)



**Strip LED Aluminum FR-4 lighting PCB board 9...**

★★★★★

High quality, fast delivery, good service, competitive price, lucky and happy to purchase from O-leading!

[回复该评论](#)

订单编号: 49024962001024670

供应商服务: 非常满意 (5 stars) 按时发货: 非常满意 (5 stars)



**High quality Keyboard pcb & pcba Factory SMT...**

★★★★★

Top quality, it's the right choice to choose O-leading to make the PCB & PCBA

[回复该评论](#)

订单编号: 4093842301024670

供应商服务: 非常满意 (5 stars) 按时发货: 非常满意 (5 stars)



**Professional Printed Circuit Board Manufactur...**

★★★★★

Very high quality PCB products, O-leading is the best PCB supplier that we have ever worked with.

订单编号: 44068794501034670

供应商服务: 非常满意 (5 stars) 按时发货: 非常满意 (5 stars)



**High TG180 FR-4 Circuit HDI PCB 94V0 Board ...**

★★★★★

We bought two batches, one by DHL, the other one by air, good quality and fast delivery!

LISTEN TO CUSTOMER VOICE

订单编号: 40903347501024670

供应商服务: 非常满意 (5 stars) 按时发货: 非常满意 (5 stars)



**Strip LED Aluminum FR-4 lighting PCB board 9...**

★★★★★

Very fast delivery! Fantastic, good job!!



**Professional Printed Circuit Board Manufactur...**

★★★★★

Very happy to great support from O-leading, they are not only professional on the PCB, but also provide good PCB products, very good supplier!

订单编号: 36919647001024670

供应商服务: 非常满意 (5 stars) 按时发货: 非常满意 (5 stars)



**AML-S802 Quad-core Android embedded boar...**

★★★★★

Good products



**Fast delivery low cost pcb fabrication O-leadin...**

★★★★★

Good supplier

订单编号: 37378603001024670

供应商服务: 非常满意 (5 stars) 按时发货: 非常满意 (5 stars)



**hot sale rigid-flexible PCB with 0.2mm BGA an...**

★★★★★

very professional supplier



**High Quality custom FPCB/Flex PCB/FPC/Flexi...**

★★★★★

Good product



**OEM ODM PCBA Bluetooth Wireless Marking G...**

★★★★★

high soldering quality



**Electronic parts haptic pcba Circuit Board asse...**

★★★★★

Very Good product

订单编号: 36919647001024670

供应商服务: 非常满意 (5 stars) 按时发货: 非常满意 (5 stars)



**Lidar IR Sensor board pcba(H08R6x)**

★★★★★

perfect product



**Customized PCBA design PCB design**

★★★★★

perfect



**Audio Speaker and Headphone Jack (H07R3x)**

★★★★★

High quality, good

订单编号: 37378603001024670

供应商服务: 非常满意 (5 stars) 按时发货: 非常满意 (5 stars)



**Raspberry pi 0 Zero Raspberry Pi Zero P1 W ver...**

★★★★★

Fantastic products!!



**double layer pcb with red S/M and LF-HASL su...**

★★★★★

Good!

订单编号: 36919647001024670

供应商服务: 非常满意 (5 stars) 按时发货: 非常满意 (5 stars)



**half hole pcb, half hole pcb module, half hole m...**

★★★★★

Top half hole pcb supplier, very perfect goods



**High Quality custom FPCB/Flex PCB/FPC/Flexi...**

★★★★★

this rigid-flexible pcb quality is perfect!



**Electronic parts haptic pcba Circuit Board asse...**

★★★★★

Very satisfied with O-leading products and quality, especially their on-time delivery, fantastic!

Be kind to your client,  
because he has many choices,  
but he chooses you instead.

# Certificazioni

O-LEADING *TRAINING*



Keep *LEARNING*

There's a phrase in Buddhism, 'Beginner's mind.'

It's wonderful to have a beginner's mind

WE HAVE A *DREAM*

Keep *RUNNING*

I would like to live to study, and not study to live.

----Bacon

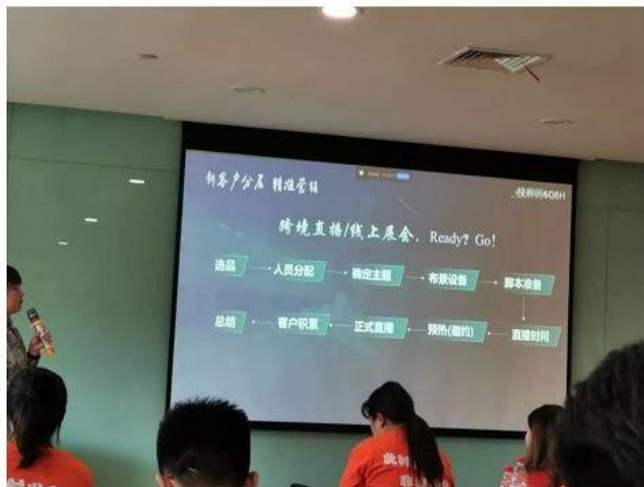





**Test Report** No. SZXEC1900530401 Date: 30 Mar 2019 Page 1 of 6

O-LEADING SUPPLY CHAIN (HK) CO., LIMITED  
1313.FLOOR 13, FORTUNE BUILDING, DANSHUI TOWN, HUIYANG DISTRICT, HUIZHOU, GUANGDONG, CHINA

The following sample(s) was/were submitted and identified on behalf of the clients as : OSP

SGS Job No. : RP19-005089 - SZ  
Date of Sample Received : 22 Mar 2019  
Testing Period : 22 Mar 2019 - 30 Mar 2019  
Test Requested : Selected tests(s) as requested by client.  
Test Method : Please refer to next page(s).  
Test Results : Please refer to next page(s).

Conclusion : Based on the performed tests on submitted sample(s), the results of Lead, Mercury, Cadmium, Hexavalent chromium, Polybrominated biphenyls (PBBs), Polybrominated diphenyl ethers (PBDEs) and Phthalates such as Bis(2-ethylhexyl) phthalate (DEHP), Butyl benzyl phthalate (BBP), Dibutyl phthalate (DBP), and Diisobutyl phthalate (DIBP) comply with the limits as set by RoHS Directive (EU) 2015/863 amending Annex II to Directive 2011/65/EU.

Signed for and on behalf of  
SGS-CSTC Standards Technical Services Co., Ltd. Shenzhen Branch

*Tina*  
Tina Fan  
Approved Signatory



Unless otherwise agreed in writing, this document is issued by the Company subject to its General Conditions of Service printed on the reverse side of this document or available at [www.sgs.com](http://www.sgs.com). The Client's attention is drawn to the limitation of liability, indemnification and jurisdiction clauses defined therein. Any holder of this document is advised that information contained herein reflects the Company's findings at the time of its intervention only and within the limits of the Client's instructions. In any event, the Company's sole responsibility is to its Client and the document does not exonerate parties to a transaction from respecting all their rights and obligations under the transaction documents. This document cannot be reproduced or used in any manner whatsoever without the prior written approval of the Company. Any unauthorized alteration, forgery or falsification of the content or appearance of this document is unlawful and offenders may be prosecuted to the fullest extent of the law. Unless otherwise stated the liability shown in this report refers only to the specific tested item.

Attention: To check the authenticity of testing SGS-CSTC Reports & certificates, please contact us at telephone: (86-755) 8307 1443 or website: [CN.sgs.com](http://CN.sgs.com)

SGS 检测有限公司 深圳分公司 地址: 深圳市福田区中康路12号卓越世纪中心1号楼1501-1502室 邮编: 518029 电话: 86-755-83071443 传真: 86-755-25888888 电子邮箱: [sgs@sgs.com](mailto:sgs@sgs.com)

Member of the SGS Group (SGS SA)



**Test Report** No. SZXEC1900530401 Date: 30 Mar 2019 Page 2 of 6

Test Results :

**Test Part Description :**

Specimen No.	SGS Sample ID	Description
SN1	SZX19-005304.001	Green"PCB"

- Remarks :
- (1) 1 mg/kg = 1 ppm = 0.0001%
  - (2) MDL = Method Detection Limit
  - (3) ND = Not Detected (< MDL)
  - (4) "-" = Not Regulated

**RoHS Directive (EU) 2015/863 amending Annex II to Directive 2011/65/EU**

Test Method : With reference to IEC 62321-4:2013+A1:2017, IEC62321-5:2013, IEC62321-7-2:2017, IEC 62321-6:2015 and IEC62321-8:2017, analyzed by ICP-OES, UV-Vis and GC-MS.

Test Item(s)	Limit	Unit	MDL	0/1
Cadmium (Cd)	100	mg/kg	2	ND
Lead (Pb)	1,000	mg/kg	2	8
Mercury (Hg)	1,000	mg/kg	2	ND
Hexavalent Chromium (Cr(VI))	1,000	mg/kg	8	ND
Sum of PBBs	1,000	mg/kg	-	ND
Monobromobiphenyl	-	mg/kg	5	ND
Dibromobiphenyl	-	mg/kg	5	ND
Tribromobiphenyl	-	mg/kg	5	ND
Tetrabromobiphenyl	-	mg/kg	5	ND
Pentabromobiphenyl	-	mg/kg	5	ND
Hexabromobiphenyl	-	mg/kg	5	ND
Heptabromobiphenyl	-	mg/kg	5	ND
Octabromobiphenyl	-	mg/kg	5	ND
Nonabromobiphenyl	-	mg/kg	5	ND
Decabromobiphenyl	-	mg/kg	5	ND
Sum of PBDEs	1,000	mg/kg	-	ND
Monobromodiphenyl ether	-	mg/kg	5	ND
Dibromodiphenyl ether	-	mg/kg	5	ND
Tribromodiphenyl ether	-	mg/kg	5	ND
Tetrabromodiphenyl ether	-	mg/kg	5	ND
Pentabromodiphenyl ether	-	mg/kg	5	ND



Unless otherwise agreed in writing, this document is issued by the Company subject to its General Conditions of Service printed on the reverse side of this document or available at [www.sgs.com](http://www.sgs.com). The Client's attention is drawn to the limitation of liability, indemnification and jurisdiction clauses defined therein. Any holder of this document is advised that information contained herein reflects the Company's findings at the time of its intervention only and within the limits of the Client's instructions. In any event, the Company's sole responsibility is to its Client and this document does not exonerate parties to a transaction from respecting all their rights and obligations under the transaction documents. This document cannot be reproduced or used in any manner whatsoever without the prior written approval of the Company. Any unauthorized alteration, forgery or falsification of the content or appearance of this document is unlawful and offenders may be prosecuted to the fullest extent of the law. Unless otherwise stated the liability shown in this report refers only to the specific tested item.

Attention: To check the authenticity of testing SGS-CSTC Reports & certificates, please contact us at telephone: (86-755) 8307 1443 or website: [CN.sgs.com](http://CN.sgs.com)

SGS 检测有限公司 深圳分公司 地址: 深圳市福田区中康路12号卓越世纪中心1号楼1501-1502室 邮编: 518029 电话: 86-755-83071443 传真: 86-755-25888888 电子邮箱: [sgs@sgs.com](mailto:sgs@sgs.com)

Member of the SGS Group (SGS SA)



## ZPMV2.E490354 - WIRING, PRINTED - COMPONENT

## Wiring, Printed - Component

See General Information for Wiring, Printed - Component

**O-LEADING SUPPLY CHAIN (HK) CO LTD**

E490354

ROOM 1205, 12/F  
TAI SANG BANK BLDG  
130-132 DES VOEUS ROAD  
CENTRAL, HONG KONG

Type	Cond Width			SS/ DS/ DSO	Max	Max			Meets UL796	C T	
	Min	Cond	Area		Solder	Flame	Class				
	Min	Edge			Thk			Oper			
mm(in)	mm(in)	mic(mil)	Diam	Limits	Temp	DSR	I				
<b>Multilayer (mass laminate) printed wiring boards.</b>											
<b>O-LEADING-401</b>	0.1 (0.004)	0.3 (0.012)	34 (1.34)	DS	12.7 (0.5)	260	10	130	V-0	-	-
<b>O-LEADING-407</b>	0.08 (0.003)	0.2 (0.008)	17 (0.67)	DS	9.7 (0.4)	260	10	130	V-0	All	-
<b>Multilayer printed wiring boards.</b>											
<b>O-LEADING-408</b>	0.125 (0.005)	0.125 (0.005)	12 (0.47) Int:136	DS	50.8 (2.0)	280	20	130	V-0	All	*
<b>Single layer printed wiring boards.</b>											
<b>O-LEADING-002</b>	0.38 (0.015)	1.14 (0.045)	34 (1.34)	SS	19.1 (0.8)	260	10	105	V-0	All	-
<b>O-LEADING-003</b>	0.38 (0.015)	1.14 (0.045)	34 (1.34)	SS	19.1 (0.8)	260	10	130	V-0	▲	-
<b>O-LEADING-033</b>	0.15 (0.006)	0.3 (0.012)	34 (1.34)	SS	25.4 (1.0)	260	10	120	V-0	All	-
<b>O-LEADING-205</b>	0.1 (0.004)	0.3 (0.012)	34 (1.34)	DS	69.6 (2.7)	260	10	130	V-0	All	-
<b>O-LEADING-206</b>	0.15 (0.006)	0.33 (0.013)	17 (0.67)	DS	69.6 (2.7)	260	10	130	V-0	All	-
<b>O-LEADING-D01</b>	0.14 (0.006)	0.15 (0.006)	33 (1.30)	DS	25.4 (1.0)	260	10	130	V-0	All	*
<b>O-LEADING-S01</b>	0.25 (0.010)	0.25 (0.010)	17 (0.67)	SS	25.4 (1.0)	260	4	130	V-0	All	*

## WIRING, PRINTED - COMPONENT | UL Product iQ

<b>O-LEADING-S02</b>	0.2 (0.008)	0.2 (0.008)	17 (0.67)	SS	25.4 (1.0)	260	4	130	HB	▲	*
<b>O-LEADING-S03</b>	0.25 (0.010)	0.25 (0.010)	34 (1.34)	SS	25.4 (1.0)	260	4	130	V-0	All	*

\* - CTI marking is optional and may be marked on the printed wiring board.

Marking: Company name or file number and type designation. May be followed by a suffix to denote factory identification or burning test classification.

并不是所有出现在本数据库中的公司名称和产品都满足了UL跟踪检验服务的要求。只有带有UL标志的产品，才应该被视为经过UL认证，并满足UL跟踪检验服务的要求。注意查看产品上的标志。

UL 允许在线认证目录中所含材料的复制遵循以下条件：1.指南信息、装配、构造、设计、系统和/或认证（文件）必须在不篡改任何数据（或图纸）的情况下完整且无误导性地呈现。2.经UL允许从在线认证目录转载“声明必须出现在所提取材料的邻近位置。此外，转载材料必须包含以下格式的版权声明：“© 2019 UL LLC”

# Capacità di processo

## Capacità di produzione PCB.

Conteggio del livello	1Layer-32layer.
Spessore di rame finito	1 / 3OZ-12OZ
Min Larghezza linea / spaziatura interna	3.0mil / 3.0mil.
Larghezza minima linea / spaziatura esterna	4.0mil / 4.0mil.
Rapporto Max Aspect.	10: 1.
Spessore del bordo	0,2 mm-5.0mm.
Dimensione massima del pannello (pollici)	635 * 1500mm.
Dimensione minima del foro forato	4Mil
Tolleranza del foro piegata	+/- 3mil.
BIIND / Vias sepolti (tipi AII)	Sì
Via Riempimento (conduttivo, non-conduttivo)	Sì
Materiale di base	FR-4, FR-4High TG. MATERIALE GRATUITO FREE, ROGERS, BASE DI ALLUMINIO, Poliimmide, rame pesante
Finiture superficiali	Hasl, osp, enig, hal-lf, Immersion argento, Tin di LMMER, dita d'oro, inchiostro del carbonio

## Capacità di produzione SMT.

Materiale PCB	FR-4, CEM-1, CEM-3, scheda a base di alluminio, FPC
Dimensione max PCB.	510x1500mm.
MIN Dimensioni PCB.	50x50mm.
Spessore PCB.	0,5 mm-4.5mm.
Spessore del bordo	0,5-4mm.
Dimensione dei componenti min	0201.
Componente di dimensioni del chip standard	0603 e più grande
Componente massima altezza	15mm.
Min Pitch	0.3mm.
Min BGA Ball Pitch	0.4mm.
Precisione del posizionamento	+/- 0,03mm.

# Confezione e consegna

# Shipping service



Quick Turn Lead Time		
Layer Count:	Lead Tim	Special Requirement
1L/2L	2-3days	24 Hours,48 Hours
4L	3-4days	48 Hours
6L	4-5days	72 Hours
8L	5-6days	NA
10L	6-7days	NA
12L	7-8days	NA
14L	8-9days	NA

Standard Lead Time		
Layer Count:	Sample Lead Time	Volume order lead time
2L	4 days	10 days
4L	5 days	11 days
6L	6 days	12 days
8L	8 days	14 days
10L	10 days	16 days
12L	12 days	18 days
14L	14 days	20 days
16-32L	18 days	24 days

## FAQ

### 1. In che modo gli o-leader garantiscono la qualità? Il nostro standard di alta qualità è ottenuto con quanto segue.

- 1.1 Il processo è rigorosamente controllato secondo gli standard ISO 9001: 2008.
- 1.2 Ampio uso del software nella gestione del processo di produzione
- 1.3 Attrezzature e strumenti di test all'avanguardia. Per esempio. Sonda volante, ispezione a raggi X, AOI (ispettore ottico automatico) e TIC (test in circuito).
- 1.4. Team di garanzia della qualità ridotto con processo di analisi del caso fallimento
- 1.5. Formazione e istruzione del personaleContinuo

### 2. In che modo O-leader mantiene il prezzo competitivo?

Nell'ultimo decennio, i prezzi di molte materie prime (ad es. Rame, prodotti chimici) erano raddoppiati, triplicati o quadruplicati; La valuta cinese RMB aveva apprezzato il 31% sul dollaro USA; E anche il nostro costo del lavoro è aumentato in modo significativo.

Tuttavia, o-leader ha mantenuto il prezzo fisso. Questo possiede interamente alle nostre innovazioni nel ridurre i costi, evitando i rifiuti e il miglioramento dell'efficienza. I nostri prezzi sono molto competitivi nel settore allo stesso livello di qualità.

Crediamo in una partnership win-win con i nostri clienti. La nostra partnership sarà reciprocamente vantaggiosa se possiamo fornirti un costo e una qualità di Edgeon.

### **3. Che tipo di schede possono il processo di leader o?**

Common FR4, Schede ad alte TG e alogeni, Rogers, Arlon, Telfon, alluminio / schede a base di rame, PI, ecc.

### **4. Quali dati sono necessari per la produzione PCB e PCBA?**

4.1 BOM (Bill of Materials) Con Designatori di riferimento: descrizione dei componenti, nome del produttore e numero di parte.

4.2 File Gerber PCB.

4.3 Disegno di fabbricazione PCB e disegno di assemblaggio PCBA.

4.4 Procedure di prova.

4.5 Eventuali restrizioni meccaniche come requisiti di altezza di assemblaggio.

### **5. Qual è il flusso di processo tipico per PCB multistrato?**

Taglio del materiale → Film secco interno → Interiore dell'incisione → Interno Aoi → Multi-Bond → Strati Stack Up Pressatura → Foratura → PTH → Placcatura del pannello → Pellicola a secco esterno → Pellicola a secco → Placcatura del motivo → Incisione esterna → Esterno Aoi → Maschera di saldatura → Marchio del componente → Finitura superficiale → Routing → E / T → Ispezione visiva.

### **6. Quali sono le apparecchiature chiave per la produzione di hdi?**

L'elenco delle apparecchiature chiave è il seguente: perforatrice laser, macchina per la pressatrice, linea VCP, macchina per esposizione automatica, LDI e ecc.

Le apparecchiature che abbiamo sono le migliori del settore, le perforatrici laser provengono da Mitsubishi e Hitachi, le macchine LDI sono provenienti da schermo (Giappone), anche le macchine per l'esposizione automatica sono anche da Hitachi, tutte effettuano che possiamo soddisfare i requisiti tecnici del cliente.

### **7. Quanti tipi di finitura superficiale o-piombo possono fare?**

O-Il leader ha la serie completa di finitura superficiale, come ad esempio: enig, osp, lf-hasl, placcatura in oro (morbido / duro), argento ad immersione, stagno, placcatura d'argento, placcatura di stagno, inchiostro di immersione e ecc. OSP, enig, osp + enig Comunemente usato sull'HDI, di solito consigliamo di utilizzare un client o osps osp + ITIG se la dimensione del pad BGA è inferiore a 0,3 mm.

### **8. Qual è la tua capacità di FPC? L'o-leader può fornire anche un servizio SMT?**

O-leader in grado di fabbricare il FPC dal singolo livello a 8layer, le dimensioni del pannello di lavoro possono essere grandi come 2000mm \* 240mm, si prega di trovare i dettagli nella pagina "Capacità Flex" Forniamo anche un servizio SMT one stop al cliente.

### **9. Quali sono i principali fattori che influenzeranno il prezzo del PCB?**

Materiale;

Finitura superficiale;

Difficoltà tecnologica;

Criteri di qualità diversi;

Caratteristiche del PCB;

Termini di pagamento;

Diversi paesi produttivi.

### **10. Qual è la definizione di PCB, PWB e FPC e qual è la differenza?**

PCB è corto per circuito stampato;

PWB è corto per la scheda di filo stampato, stesso significato del circuito stampato;

FPC è corto per una scheda stampata flessibile.

### **11. Quali fattori dovrebbero essere considerati quando si sceglie il materiale per una scheda PCB?**

Sotto i fattori dovrebbero essere considerati quando scegliamo il materiale per PCB:

Il valore TG del materiale dovrebbe essere maggiore della temperatura operativa;

Basso materiale CTE ha una buona prestazione della stabilità termica;

Buone prestazioni termiche resistenze: normalmente i PCB sono necessari per resistere a 250 °C per almeno 50 anni.

Buona piattezza; In considerazione delle proprietà elettriche, il materiale di bassa perdita / alta permittività è utilizzato su PCB ad alta frequenza; Substrato in fibra di vetro polimidrico utilizzato per PCB flessibile; Il nucleo in metallo viene utilizzato quando il prodotto ha requisito rigoroso della dissipazione del calore.

### **12. Quali sono i meriti del PCB rigido-Flex di O-Stainer?**

Il PCB rigido-Flex di O-Leading ha i caratteri di FPC e PCB, quindi può essere utilizzato in alcuni prodotti speciali. Alcune parti sono flessibili mentre l'altra parte rigida, può aiutare a salvare lo spazio interno del prodotto, ridurre il volume del prodotto e migliorare le prestazioni.

### **13. Come fare il calcolo dell'impedenza?**

Il sistema di controllo dell'impedenza viene eseguito utilizzando alcuni tagliandi di prova, il SI6000 morbido e l'apparecchiatura CITS 500S da strumenti polari.

L'attrezzatura misura l'impedenza su un coupon di configurazione del brano rappresentativo di cui il cliente ci ha dato un valore e una tolleranza determinati.