

# Welcome to O-leading

O-Leading strives to be your one stop solution partner in EMS supply chain, including PCB design , PCB fabrication and PCB assembly (PCBA),We provide some of the most advanced PCB technology, including HDI PCBs,multilayer PCBs, Rigid-Flexible PCBs.We can support from quick turn prototype to medium & mass Production. ([Control Board Design and Manufacturing Pcb and PCBA Assembling](#))

In general, our global customers are very impressed with our services:Rapid response, competitive price and quality commitment.Providing more valuable technical service and overall solution is the way O-leading forward.

Looking to the future, O-leading will concentrate on the innovation and development of electronics manufacturing technology as always, and make persistent efforts on PCB & PCBA one-stop service to provide first-class services and create more value for our customers.

PLEASE CLICK THESE FOR MORE INFORMATION [Electronic Oem 4 Layer Printed Circuit Board Assembly Sensor Pcba Factory](#)

## Product Description

# HOW O-LEADING MAKE A PROJECT FOR YOU

Hardware Dispenser Application Not

## Automatic Dispenser Application Not

Voltage Table

Volt Pin Number	Description
VDD	Battery voltage
+3V3	+3.3V
+5V	+5V
USB +5V	USB 5V input
+5V/2	Isolated +5V
+12V	12V DC Drive

STM32F072 PINOUT table

Wire Name	Description	DIO	Mode	Note
SMTN_TOF	Shutdown Time of flight sensor	Output		Logic '0' to shutdown
I2C_SCL_TOF	I2C communication with time of flight sensor	I2C1_SCL		
I2C_SDA_TOF	I2C communication with thermopile sensor	I2C1_SDA		
I2C_SCL_IR	I2C communication with thermopile sensor	I2C2_SCL		
I2C_SDA_IR	I2C communication with thermopile sensor	I2C2_SDA		
RATE_LC	Load cell control pins	Output		
DOUT_LC	Load cell control pins	Output		

**O-LEADING**  
TO BE RELIABLE, TO BE AVAILABLE

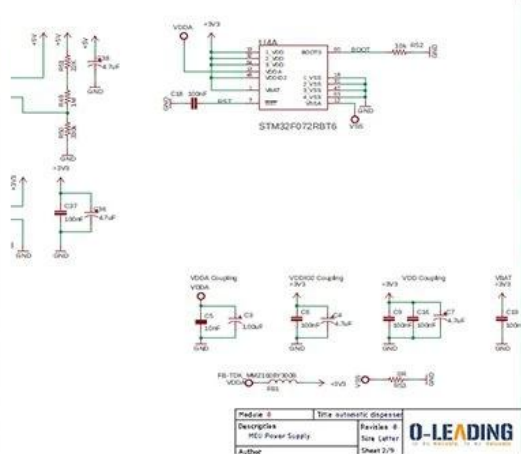

## HARDWARE schematics

## PCB PRODUCTION COMPONENTS SOURCING

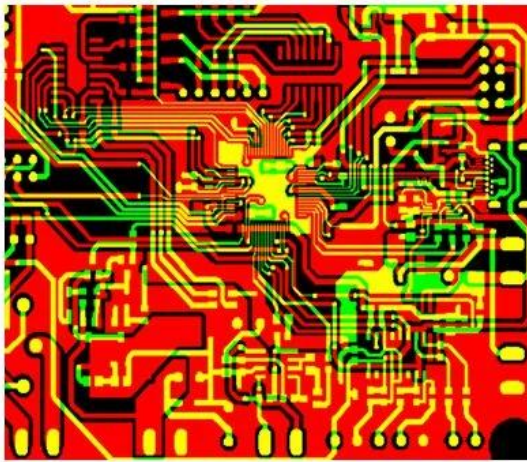

Qty	Value	Device	Parts	Description
4	AK500/2	AK500/2	X1, X2	CONNECTOR
1	AK500/3	AK500/3	X7	CONNECTOR
1	1241148	MA04-2	SV2	
1	PPPC04	MA04-2	SV1	8 POS, 4*2 FEMALE PIN HEAD
1	ML10	ML10	SV4	HARTING
1	8MHZ	XTALL_CSTCE8M	X5	STCE8M00G52-R0 RESONATOR
1	0R	R-0603	R53	Thick Film Resistors - SMD 0603
2	10R	R-0603	R12, R5	Thick Film Resistors - SMD 0603
8	100R	R-0603	R1, R2	Thick Film Resistors - SMD 0603
1	270R	R-0805	R15	Thick Film Resistors - SMD 0605
1	330R	R-0603	R11	Thick Film Resistors - SMD 0603
9	680R	R-0603	R20, R3	Thick Film Resistors - SMD 0603
17	1k	R-0603	R9, R10	Thick Film Resistors - SMD 0603
2	4.7k	R-0603	R17, R6	Thick Film Resistors - SMD 0603
2	5.1k	R-0603	R18, R1	Thick Film Resistors - SMD 0603
9	10k	R-0603	R16, R3	Thick Film Resistors - SMD 0603

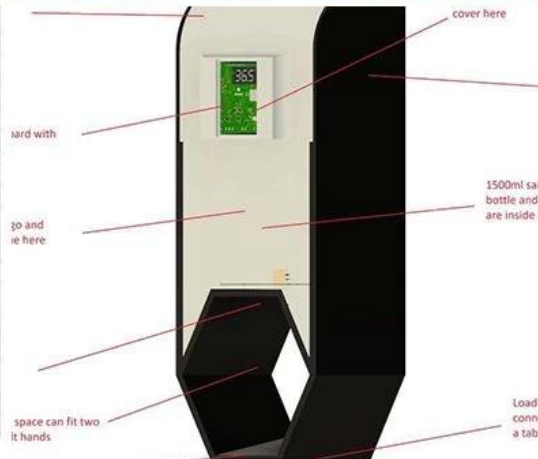

## PCB Assembly MECHANICAL DESIGN

TOP QUALITY PCBA

**O-LEADING**

To Be Reliable, To Be Valuable



MAKE YOUR IDEA COME **TRUE**

TOP QUALITY PCBA

**O-LEADING**

To Be **Reliable**, To Be **Valuable**

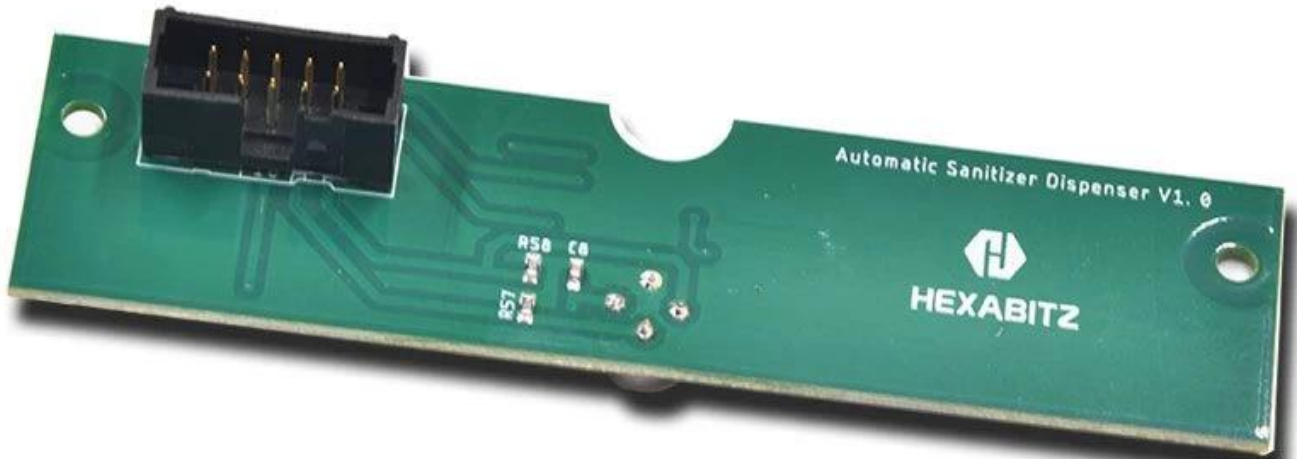

MAKE YOUR IDEA COME **TRUE**

TOP QUALITY PCBA

**O-LEADING**

To Be Reliable, To Be Valuable

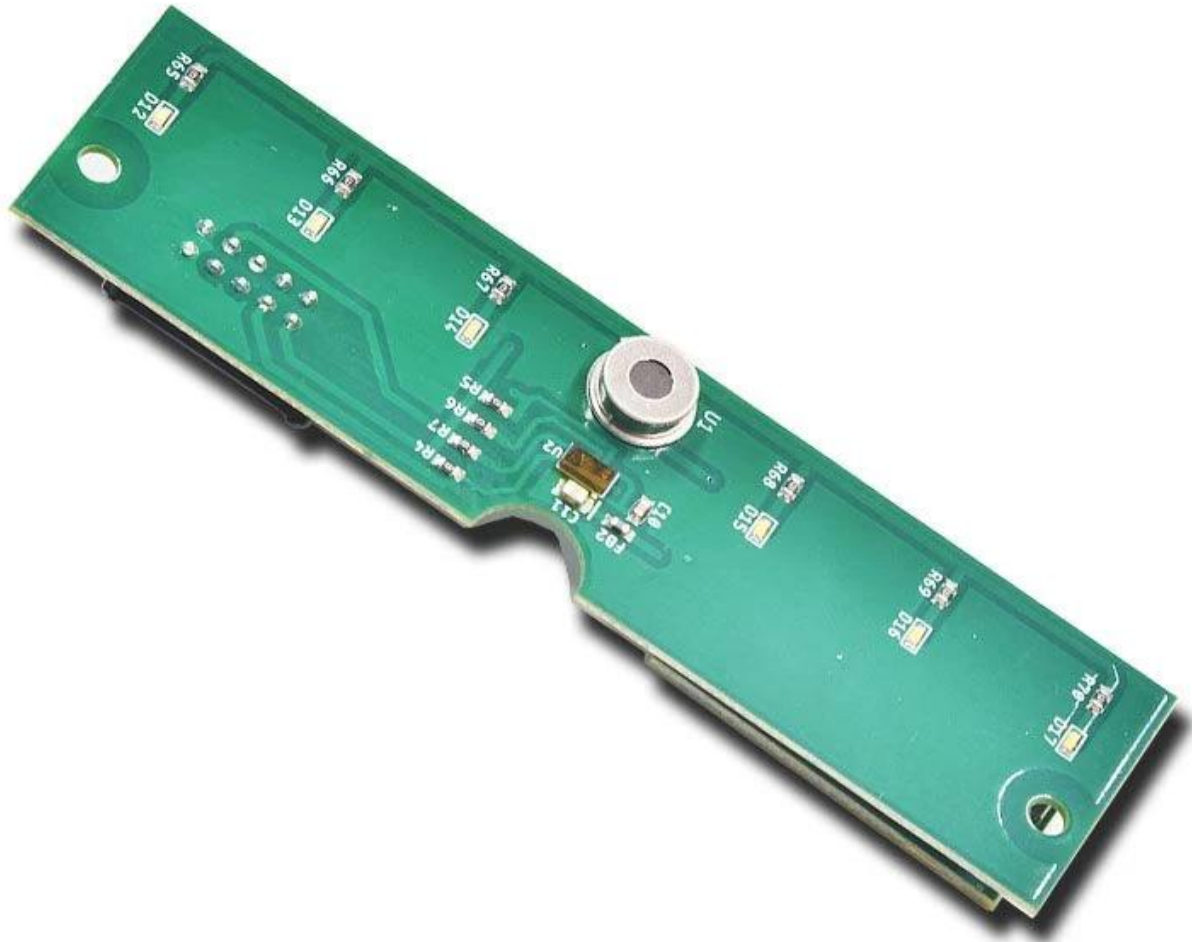

MAKE YOUR IDEA COME **TRUE**

## Process Flow Chart

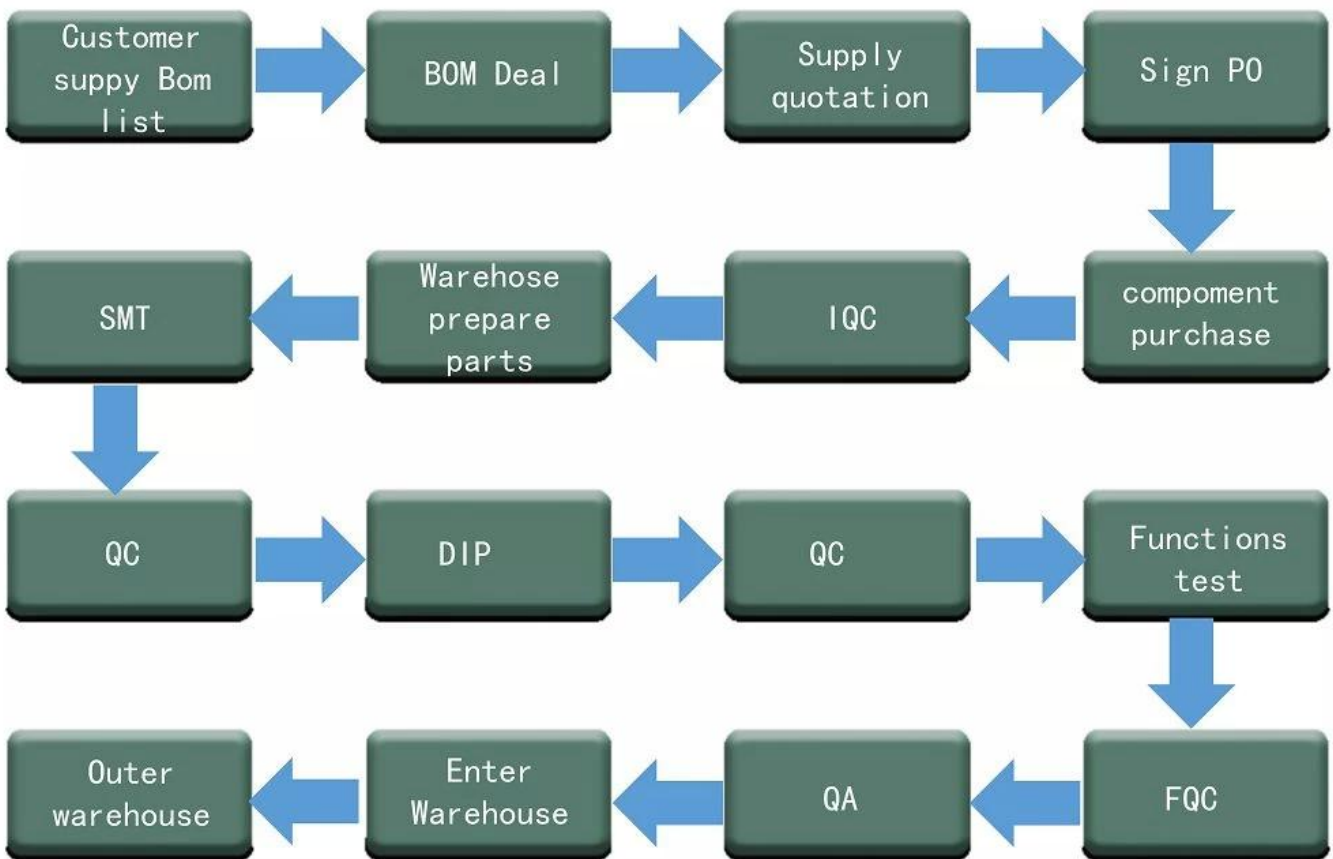

## Quality Control Process

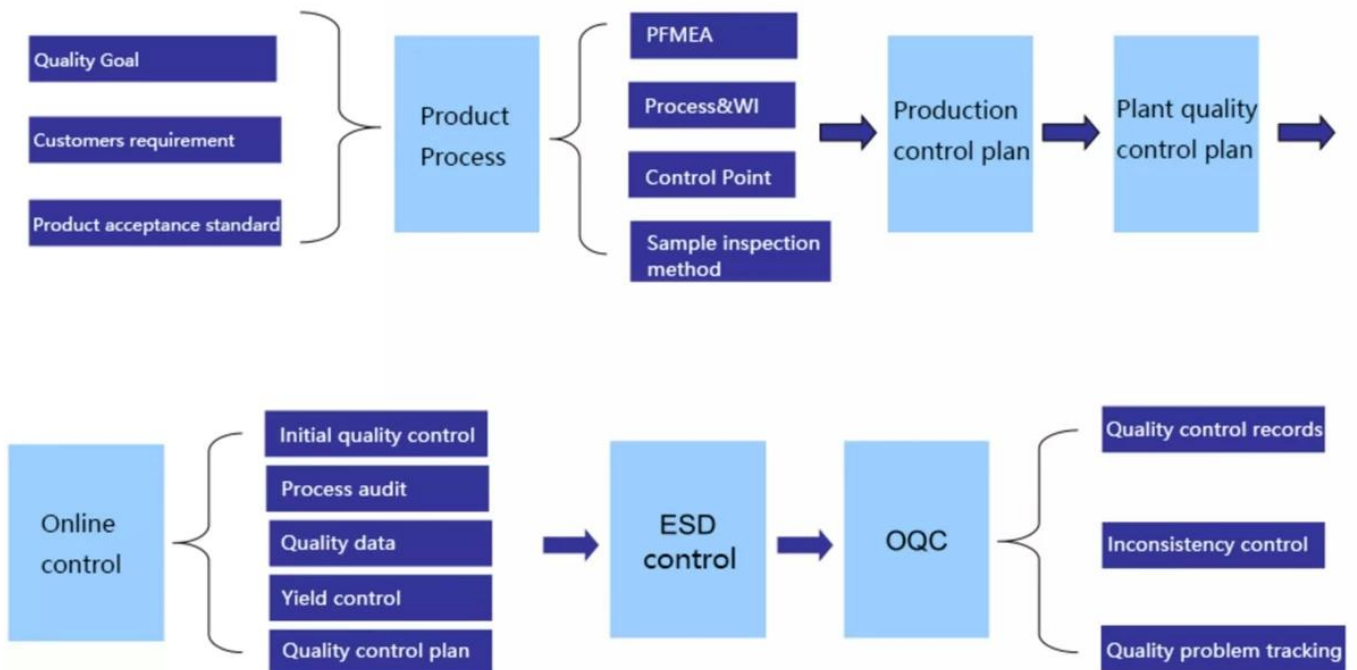



## Our Team

O-LEADING *CUSTOMER*

To be *RELIABLE*

- Quality first ,
- Customer supreme ,
- Scientifically management ,
- Striving for famous brand



*THE CUSTOMER IS KING*

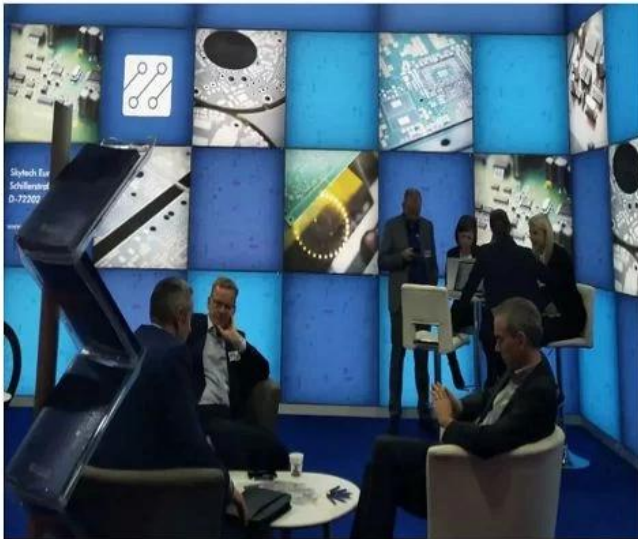

To be *VALUABLE*

- Science and technology keeps head ,
- Put people first ,
- Be precise and practical ,
- contribute sincerely

---

Factory PCB

---



Automatic vacuum press machine



Drilling Machine



Pattern Plating Machine



Scrubbing Machine



Developing Machine



Routing Machine



High-speed flying probe machine



E-test Machine

---

Factory SMT

---





Skyworth 创维

**HET** 和而泰  
HET INTELLIGENT CONTROL

dongweikeji  
东威科技

美的 Midea

STAR-NET  
星网锐捷

FORYOU  
ADAYO 华阳集团

**EDIFIER**<sup>®</sup>

Cultraview 金锐显

3nod 三诺

**T&W**

**TCL**

AcBel 康舒科技  
ACBEL POLYTECH INC.

**Honeywell**

Schneider  
Electric

**ZTE**中兴

**EMERSON**

**BYD**

**PHILIPS**

**TE**  
connectivity

**VIDEOTON**

CUSTOMER VOICE IS **EXTREMELY IMPORTANT** TO US

订单编号: 49335463501024670

供应商服务: 非常满意 (5 stars) 按时发货: 非常满意 (5 stars)



**High quality usb power pcb , pcba manufacturer**

★★★★★

Fancy has done an excellent job, whenever we write, she answered us within 1 second, O-leading is very perfect with fast delivery, fast logistics, the most important thing is good quality, good packaging, thank you!

[回复该评论](#)



**oem customized rohs pcb drawing schematic s...**

★★★★★

We received the boards, the quality is very good, the price is very reasonable, Fancy is very nice & smart & experienced, the logistics is super fast, I will come to see more in the future.

[回复该评论](#)

订单编号: 49298271001024670

供应商服务: 非常满意 (5 stars) 按时发货: 非常满意 (5 stars)



**High TG180 FR-4 Circuit HDI PCB 94V0 Board ...**

★★★★★

perfect product, perfect PCB supplier!

[回复该评论](#)



**oem customized rohs pcb drawing schematic s...**

★★★★★

Very good and professional PCB product as usual!

[回复该评论](#)



**Strip LED Aluminum FR-4 lighting PCB board 9...**

★★★★★

High quality, fast delivery, good service, competitive price, lucky and happy to purchase from O-leading!

[回复该评论](#)

订单编号: 499249622001024670

United States

供应商服务: 非常满意 (5 stars) 按时发货: 非常满意 (5 stars)



**High quality Keyboard pcb & pcba Factory SMT...**

★★★★★

Top quality, it's the right choice to choose O-leading to make the PCB & PCBA

[回复该评论](#)

订单编号: 4998622001024670

供应商服务: 非常满意 (5 stars) 按时发货: 非常满意 (5 stars)



**Professional Printed Circuit Board Manufactur...**

★★★★★

Very high quality PCB products, O-leading is the best PCB supplier that we have ever worked with!

订单编号: 44068794501034670

供应商服务: 非常满意 (5 stars) 按时发货: 非常满意 (5 stars)



**High TG180 FR-4 Circuit HDI PCB 94V0 Board ...**

★★★★★

We bought two batches, one by DHL, the other one by air, good quality and fast delivery!

LISTEN TO **CUSTOMER VOICE**

订单编号: 40903847501024670

供应商服务: 非常满意 (5 stars) 按时发货: 非常满意 (5 stars)



**Strip LED Aluminum FR-4 lighting PCB board 9...**

★★★★★

Very fast delivery! Fantastic, good job!!



**Professional Printed Circuit Board Manufactur...**

★★★★★

Very happy to great support from O-leading, they are not only professional on the PCB, but also provide good PCB products, very good supplier!

订单编号: 36919647001024670

供应商服务: 非常满意 (5 stars) 按时发货: 非常满意 (5 stars)



**AML-S802 Quad-core Android embedded boar...**

★★★★★

Good products



**Fast delivery low cost pcb fabrication O-leadi...**

★★★★★

Good supplier



**Lidar IR Sensor board pcba(H08R6x)**

★★★★★

perfect product



**Customized PCBA design PCB design**

★★★★★

perfect



**Audio Speaker and Headphone Jack (H07R3x)**

★★★★★

High quality, good

订单编号: 37378603001024670

供应商服务: 非常满意 (5 stars) 按时发货: 非常满意 (5 stars)



**hot sale rigid-flexible PCB with 0.2mm BGA an...**

★★★★★

very professional supplier



**High Quality custom FPCB/Flex PCB/FPC/Flexi...**

★★★★★

Good product



**OEM ODM PCBA Bluetooth Wireless Marking G...**

★★★★★

high soldering quality



**Electronic parts haptic pcba Circuit Board asse...**

★★★★★

Very Good product



**half hole pcb, half hole pcb module, half hole m...**

★★★★★

Top half hole pcb supplier, very perfect goods



**High Quality custom FPCB/Flex PCB/FPC/Flexi...**

★★★★★

this rigid-flexible pcb quality is perfect!



**Electronic parts haptic pcba Circuit Board asse...**

★★★★★

Very satisfied with O-leading products and quality, especially their on-time delivery, fantastic!



**Raspberry pi 0 Zero Raspberry Pi Zero PI W ver...**

★★★★★

Fantastic products!!



**double layer pcb with red S/M and LF-HASL su...**

★★★★★

Good!

Be **kind** to your client,  
because he has many choices,  
but he chooses you instead.

# Certifications

O-LEADING *TRAINING*



Keep *LEARNING*

There's a phrase in Buddhism, 'Beginner's mind.'

It's wonderful to have a beginner's mind

WE HAVE A *DREAM*

Keep *RUNNING*

I would like to live to study, and not study to live.

----Bacon

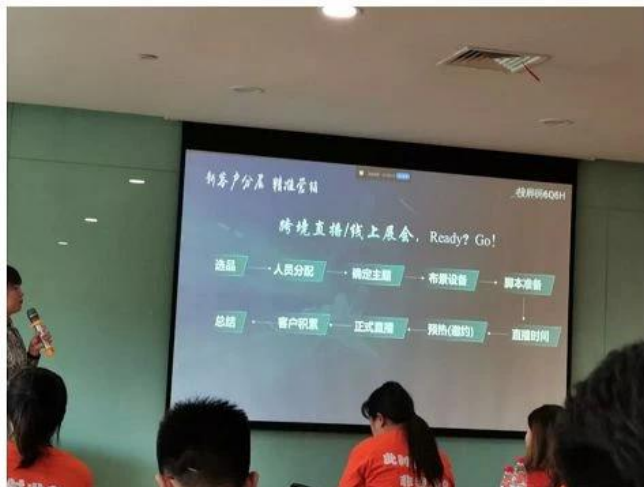



**Test Report** No. SZXEC1900530401 Date: 30 Mar 2019 Page 1 of 6

O-LEADING SUPPLY CHAIN (HK) CO., LIMITED  
1313.FLOOR 13, FORTUNE BUILDING, DANSHUI TOWN, HUIYANG DISTRICT, HUIZHOU, GUANGDONG, CHINA

The following sample(s) was/were submitted and identified on behalf of the clients as : OSP

SGS Job No. : RP19-005089 - SZ  
Date of Sample Received : 22 Mar 2019  
Testing Period : 22 Mar 2019 - 30 Mar 2019  
Test Requested : Selected tests(s) as requested by client.  
Test Method : Please refer to next page(s).  
Test Results : Please refer to next page(s).

Conclusion : Based on the performed tests on submitted sample(s), the results of Lead, Mercury, Cadmium, Hexavalent chromium, Polybrominated biphenyls (PBBs), Polybrominated diphenyl ethers (PBDEs) and Phthalates such as Bis(2-ethylhexyl) phthalate (DEHP), Butyl benzyl phthalate (BBP), Dibutyl phthalate (DBP), and Diisobutyl phthalate (DIBP) comply with the limits as set by RoHS Directive (EU) 2015/863 amending Annex II to Directive 2011/65/EU.

Signed for and on behalf of  
SGS-CSTC Standards Technical Services Co., Ltd. Shenzhen Branch

*Tina*  
Tina Fan  
Approved Signatory



Unless otherwise agreed in writing, this document is issued by the Company subject to its General Conditions of Service printed on the reverse side of this document or available at [www.sgs.com](http://www.sgs.com). The Client's attention is drawn to the limitation of liability, indemnification and jurisdiction clauses defined therein. Any holder of this document is advised that information contained herein reflects the Company's findings at the time of its intervention only and within the limits of the Client's instructions. In any case, the Company's sole responsibility is to its Client and the document does not exonerate parties to a transaction from respecting all their rights and obligations under the transaction documents. This document cannot be reproduced or used in any manner whatsoever without the prior written approval of the Company. Any unauthorized alteration, forgery or falsification of the content or appearance of this document is unlawful and offenders may be prosecuted to the fullest extent of the law. Unless otherwise stated the liability shown in this report refers only to the specific tested item.

Attention: To check the authenticity of testing SGS-CSTC Reports & certificates, please contact us at telephone: (86-755) 8307 1443 or website: [CN.sgs.com](http://CN.sgs.com)

SGS 检测有限公司 深圳分公司 地址: 深圳市福田区福安路11号 邮编: 518129 电话: (86-755) 25288888 / (86-755) 83071930 传真: (86-755) 25288888 / (86-755) 83071930 电子邮箱: [china@sgs.com](mailto:china@sgs.com)

Member of the SGS Group (SGS SA)



**Test Report** No. SZXEC1900530401 Date: 30 Mar 2019 Page 2 of 6

Test Results :

Test Part Description :

Specimen No.	SGS Sample ID	Description
SN1	SZX19-005304.001	Green"PCB"

Remarks :

- (1) 1 mg/kg = 1 ppm = 0.0001%
- (2) MDL = Method Detection Limit
- (3) ND = Not Detected (< MDL)
- (4) "-" = Not Regulated

**RoHS Directive (EU) 2015/863 amending Annex II to Directive 2011/65/EU**

Test Method : With reference to IEC 62321-4:2013+A1:2017, IEC62321-5:2013, IEC62321-7-2:2017, IEC 62321-6:2015 and IEC62321-8:2017, analyzed by ICP-OES, UV-Vis and GC-MS.

Test Item(s)	Limit	Unit	MDL	0/1
Cadmium (Cd)	100	mg/kg	2	ND
Lead (Pb)	1,000	mg/kg	2	8
Mercury (Hg)	1,000	mg/kg	2	ND
Hexavalent Chromium (Cr(VI))	1,000	mg/kg	8	ND
Sum of PBBs	1,000	mg/kg	-	ND
Monobromobiphenyl	-	mg/kg	5	ND
Dibromobiphenyl	-	mg/kg	5	ND
Tribromobiphenyl	-	mg/kg	5	ND
Tetrabromobiphenyl	-	mg/kg	5	ND
Pentabromobiphenyl	-	mg/kg	5	ND
Hexabromobiphenyl	-	mg/kg	5	ND
Heptabromobiphenyl	-	mg/kg	5	ND
Octabromobiphenyl	-	mg/kg	5	ND
Nonabromobiphenyl	-	mg/kg	5	ND
Decabromobiphenyl	-	mg/kg	5	ND
Sum of PBDEs	1,000	mg/kg	-	ND
Monobromodiphenyl ether	-	mg/kg	5	ND
Dibromodiphenyl ether	-	mg/kg	5	ND
Tribromodiphenyl ether	-	mg/kg	5	ND
Tetrabromodiphenyl ether	-	mg/kg	5	ND
Pentabromodiphenyl ether	-	mg/kg	5	ND



Unless otherwise agreed in writing, this document is issued by the Company subject to its General Conditions of Service printed on the reverse side of this document or available at [www.sgs.com](http://www.sgs.com). The Client's attention is drawn to the limitation of liability, indemnification and jurisdiction clauses defined therein. Any holder of this document is advised that information contained herein reflects the Company's findings at the time of its intervention only and within the limits of the Client's instructions. In any case, the Company's sole responsibility is to its Client and this document does not exonerate parties to a transaction from respecting all their rights and obligations under the transaction documents. This document cannot be reproduced or used in any manner whatsoever without the prior written approval of the Company. Any unauthorized alteration, forgery or falsification of the content or appearance of this document is unlawful and offenders may be prosecuted to the fullest extent of the law. Unless otherwise stated the liability shown in this report refers only to the specific tested item.

Attention: To check the authenticity of testing SGS-CSTC Reports & certificates, please contact us at telephone: (86-755) 8307 1443 or website: [CN.sgs.com](http://CN.sgs.com)

SGS 检测有限公司 深圳分公司 地址: 深圳市福田区福安路11号 邮编: 518129 电话: (86-755) 25288888 / (86-755) 83071930 传真: (86-755) 25288888 / (86-755) 83071930 电子邮箱: [china@sgs.com](mailto:china@sgs.com)

Member of the SGS Group (SGS SA)



## ZPMV2.E490354 - WIRING, PRINTED - COMPONENT

## Wiring, Printed - Component

See General Information for Wiring, Printed - Component

**O-LEADING SUPPLY CHAIN (HK) CO LTD**

E490354

ROOM 1205, 12/F  
TAI SANG BANK BLDG  
130-132 DES VOEUS ROAD  
CENTRAL, HONG KONG

Type	Cond Width			SS/ DS/ DSO	Max	Max		Meets UL796	C T	
	Min	Cond	Area		Solder	Oper	Flame			
	mm(in)	Edge Thk	Diam		Limits	Temp				Class
<b>Multilayer (mass laminate) printed wiring boards.</b>										
<b>O-LEADING-401</b>	0.1 (0.004)	0.3 (0.012)	34 (1.34)	DS	12.7 (0.5)	260	10	130	V-0	-
<b>O-LEADING-407</b>	0.08 (0.003)	0.2 (0.008)	17 (0.67)	DS	9.7 (0.4)	260	10	130	V-0	All
<b>Multilayer printed wiring boards.</b>										
<b>O-LEADING-408</b>	0.125 (0.005)	0.125 (0.005)	12 (0.47) Int:136	DS	50.8 (2.0)	280	20	130	V-0	All *
<b>Single layer printed wiring boards.</b>										
<b>O-LEADING-002</b>	0.38 (0.015)	1.14 (0.045)	34 (1.34)	SS	19.1 (0.8)	260	10	105	V-0	All -
<b>O-LEADING-003</b>	0.38 (0.015)	1.14 (0.045)	34 (1.34)	SS	19.1 (0.8)	260	10	130	V-0	▲ -
<b>O-LEADING-033</b>	0.15 (0.006)	0.3 (0.012)	34 (1.34)	SS	25.4 (1.0)	260	10	120	V-0	All -
<b>O-LEADING-205</b>	0.1 (0.004)	0.3 (0.012)	34 (1.34)	DS	69.6 (2.7)	260	10	130	V-0	All -
<b>O-LEADING-206</b>	0.15 (0.006)	0.33 (0.013)	17 (0.67)	DS	69.6 (2.7)	260	10	130	V-0	All -
<b>O-LEADING-D01</b>	0.14 (0.006)	0.15 (0.006)	33 (1.30)	DS	25.4 (1.0)	260	10	130	V-0	All *
<b>O-LEADING-S01</b>	0.25 (0.010)	0.25 (0.010)	17 (0.67)	SS	25.4 (1.0)	260	4	130	V-0	All *

## WIRING, PRINTED - COMPONENT | UL Product iQ

<b>O-LEADING-S02</b>	0.2 (0.008)	0.2 (0.008)	17 (0.67)	SS	25.4 (1.0)	260	4	130	HB	▲ *
<b>O-LEADING-S03</b>	0.25 (0.010)	0.25 (0.010)	34 (1.34)	SS	25.4 (1.0)	260	4	130	V-0	All *

\* - CTI marking is optional and may be marked on the printed wiring board.

Marking: Company name or file number and type designation. May be followed by a suffix to denote factory identification or burning test classification.

并不是所有出现在本数据库中的公司名称和产品都满足了UL跟踪检验服务的要求。只有带有UL标志的产品，才应该被视为经过UL认证，并满足UL跟踪检验服务的要求。注意查看产品上的标志。

UL 允许在线认证目录中所含材料的复制遵循以下条件：1.指南信息、装配、构造、设计、系统和/或认证（文件）必须在不篡改任何数据（或图纸）的情况下完整且无误导性地呈现。2.经UL允许从在线认证目录转载“声明必须出现在所提取材料的邻近位置。此外，转载材料必须包含以下格式的版权声明：“© 2019 UL LLC”

# Process Capability

## PCB Production Capabilities

Layer Count	1Layer-32Layer
Finished copper thickness	1/3oz-12oz
Min Line width/spacing internal	3.0mil/3.0mil
Min Line width/spacing external	4.0mil/4.0mil
Max Aspect Ratio	10:1
Board thickness	0.2mm-5.0mm
Max Panel size(inches)	635*1500mm
Minimum Drilled Hole Size	4mil
Plated Hole Tolerance	+/-3mil
Blind/Buried Vias (All Types)	YES
Via Fill(Conductive,Non-Conductive)	YES
Base Material	FR-4,FR-4high Tg,Halogen free material,Rogers,Aluminium base,Polyimide,Heavy Copper
Surface finishes	HASL,OSP,ENIG,HAL-LF,Immersion silver,Immersion Tin,Gold fingers,Carbon ink

## SMT Production Capabilities

PCB Material	FR-4,CEM-1,CEM-3,Aluminum-based board
Max PCB size	510x460mm
Min PCB size	50x50mm
PCB Thickness	0.5mm-4.5mm
Board thickness	0.5-4mm
Min Components size	0201
Standard chip size component	0603 and larger
Component max height	15mm
Min lead pitch	0.3mm
Min BGA ball pitch	0.4mm
Placement precision	+/-0.03mm

## Packaging & Delivery

# Shipping service



Quick Turn Lead Time		
Layer Count:	Lead Tim	Special Requirement
1L/2L	2-3days	24 Hours,48 Hours
4L	3-4days	48 Hours
6L	4-5days	72 Hours
8L	5-6days	NA
10L	6-7days	NA
12L	7-8days	NA
14L	8-9days	NA

Standard Lead Time		
Layer Count:	Sample Lead Time	Volume order lead time
2L	4 days	10 days
4L	5 days	11 days
6L	6 days	12 days
8L	8 days	14 days
10L	10 days	16 days
12L	12 days	18 days
14L	14 days	20 days
16-32L	18 days	24 days

## FAQ

### 1. How do O-Leading ensure quality?

Our high quality standard is achieved with the following.

1.1 The process is strictly controlled under ISO 9001:2008 standards.

1.2 Extensive use of software in managing the production process

1.3 State-of-art testing equipments and tools. E.g. Flying Probe, X-ray Inspection, AOI (Automated Optical Inspector) and ICT (in-circuit testing).

1.4.Dedicated quality assurance team with failure case analysis process

1.5.Continuous staff training and education

### 2. How do O-Leading keep your price competitive?

Over the last decade, prices of many raw materials (e.g. copper, chemicals) had doubled, tripled or quadrupled; Chinese currency RMB had appreciated 31% over US dollar; And our labor cost also increased significantly.

However, O-Leading have kept our pricing steady. This owns entirely to our innovations in reducing cost, avoiding wastes and improving efficiency. Our prices are very competitive in the industry at the same quality level.

We believe in a win-win partnership with our customers. Our partnership will be mutually beneficial if we can provide you an edgeon cost and quality.



### **3. What kinds of boards can O-Leading process?**

Common FR4, high-TG and halogen-free boards, Rogers, Arlon, Telfon, aluminum/copper-based boards, PI, etc.

### **4. What data are needed for PCB & PCBA production?**

4.1 BOM (Bill of Materials) with reference designators: component description, manufacturer's name and part number.

4.2 PCB Gerber files.

4.3 PCB fabrication drawing and PCBA assembly drawing.

4.4 Test procedures.

4.5 Any mechanical restrictions such as assembly height requirements.

### **5. What's the typical process flow for multi-layer PCB?**

Material cutting → Inner dry film → inner etching → Inner AOI → Multi-bond → Layer stack up Pressing → Drilling → PTH → Panel Plating → Outer Dry Film → Pattern Plating → Outer etching → Outer AOI → Solder Mask → Component Mark → Surface finish → Routing → E/T → Visual Inspection.

### **6. What's the key equipments for HDI manufacturing?**

Key equipment list is as following: Laser drilling machine, Pressing machine, VCP line, Automatic Exposing machine, LDI and etc.

The equipments we have are the best in the industry, laser drilling machines are from Mitsubishi and Hitachi, LDI machines are from Screen(Japan), Automatic Exposing machines are also from Hitachi, all of them make we can meet customer's technical requirements.

### **7. How many types of surface finish O-lead can do?**

O-the leader has the full series of surface finish, such as: ENIG, OSP, LF-HASL, gold plating (soft/hard), immersion silver, Tin, silver plating, immersion tin plating, carbon ink and etc. .. OSP, ENIG, OSP + ENIG commonly used on the HDI, we usually recommend that you use a client or OSP OSP + ENIG if BGA PAD size less than 0.3 mm.

### **8. What's your capability for FPC? Can O-Leading provide SMT service also?**

O-Leading can fabricate FPC from single layer to 8layer, the working panel size can be as large as 2000mm\*240mm, please find the details in the page "Flex Capability"

We also provide SMT one stop service to customer.

### **9. What are the main factors which will affect the price of PCB?**

Material;

Surface finish;

Technology difficulty;

Different quality criteria;

PCB characteristics;

Payment terms;

Different manufacturing countries.

### **10. What's the definition of PCB, PWB and FPC and what's the difference?**

PCB is short for Printed Circuit Board;

PWB is short for Printed Wire Board, same meaning as Printed Circuit Board;

FPC is short for Flexible Printed Board.

### **11. What factors should be considered when choosing the material for a PCB board?**

Below factors should be considered when we choose the material for PCB:

The material's Tg value should be greater than the operation temperature;

Low CTE material has good performance of thermal stability;

Good thermal resistance performance: Normally PCBs are required to resist 250°C for at least 50s.  
Good flatness; In consideration of the electrical properties, low loss/high permittivity material is used on high frequency PCB; Polyimide glass fiber substrate used for flexible PCB; Metal core is used when the product has strict requirement of heat dissipation.

### **12. What's the merits of O-leading's rigid-flex PCB?**

O-leading's rigid-flex PCB has the characters of both FPC and PCB, so it can be used in some special products. Some part is flexible while the other part rigid, it can help save product's interior space, reduce product volume and improve performance.

### **13. How to you make the impedance calculation?**

The impedance control system is done using some test coupons, the SI6000 soft and the CITS 500s equipment from POLAR INSTRUMENTS.

The equipment measures the impedance on a representative track configuration coupon of which the client has given us a determinate value and tolerance.