

Bienvenue chez O-Leading

O-Leading s'efforce d'être votre partenaire de solution unique dans la chaîne d'approvisionnement EMS, y compris la conception de circuits imprimés, la fabrication de circuits imprimés et l'assemblage de circuits imprimés (PCBA). Nous pouvons prendre en charge du prototype à rotation rapide à la production de moyenne et de masse. ([Fabricant de carte PCB double face de livraison ast](#))

En général, nos clients mondiaux sont très impressionnés par nos services: réponse rapide, prix compétitifs et engagement de qualité. Fournir un service technique et une solution globale plus précieuses est la voie à suivre pour O-leader.

Tourné vers l'avenir, O-Leading se concentrera sur l'innovation et le développement de la technologie de fabrication électronique, comme toujours, et fera des efforts persistants sur le service à guichet unique PCB et PCBA pour fournir des services de première classe et créer plus de valeur pour nos clients.

VEUILLEZ CLIQUER ICI POUR PLUS D'INFORMATIONS [Usine de circuits imprimés de placage d'or dur double face PCB](#)

O-LEADING
To Be Reliable, To Be Valuable

WE ALWAYS PROVIDE YOU
BEST RIGID-FLEXIBLE CIRCUIT

WE ALWAYS PROVIDE YOU
BEST HIGH DENSITY INTERCONNECT PCB



Keep *LEARNING*

There's a phrase in Buddhism, 'Beginner's mind.'

It's wonderful to have a beginner's mind

WE HAVE A *DREAM*

Keep *RUNNING*

I would like to live to study and not study to live.

---Bacon

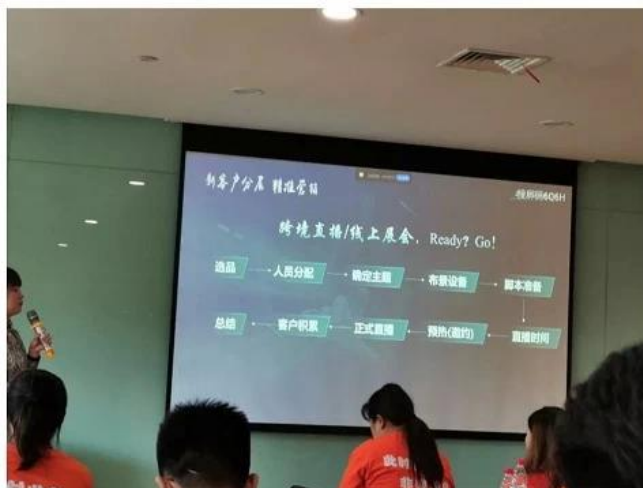

Description du produit

Guangdong Circuit Board Fournisseur fabricant de cartes de circuits imprimés Carte de circuits imprimés OEM professionnelle, fabricant de cartes de circuits imprimés Double face Pcb Hard Gold Prix d'usine 0,2 6 mm d'épaisseur Carte de circuits de placage de matériel électronique

TOP QUALITY PCBA

O-LEADING

To Be Reliable, To Be Valuable

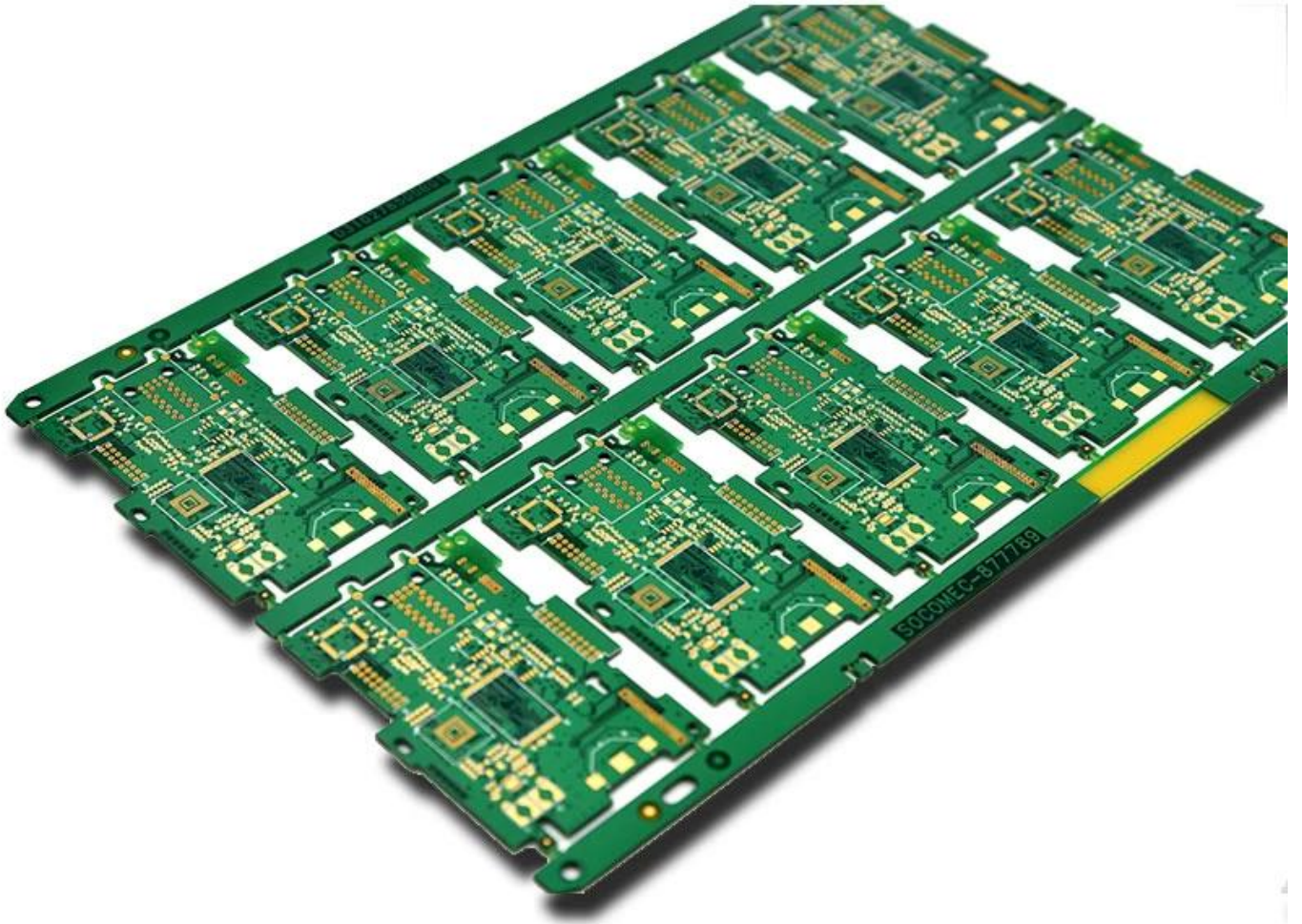

MAKE YOUR IDEA COME TRUE

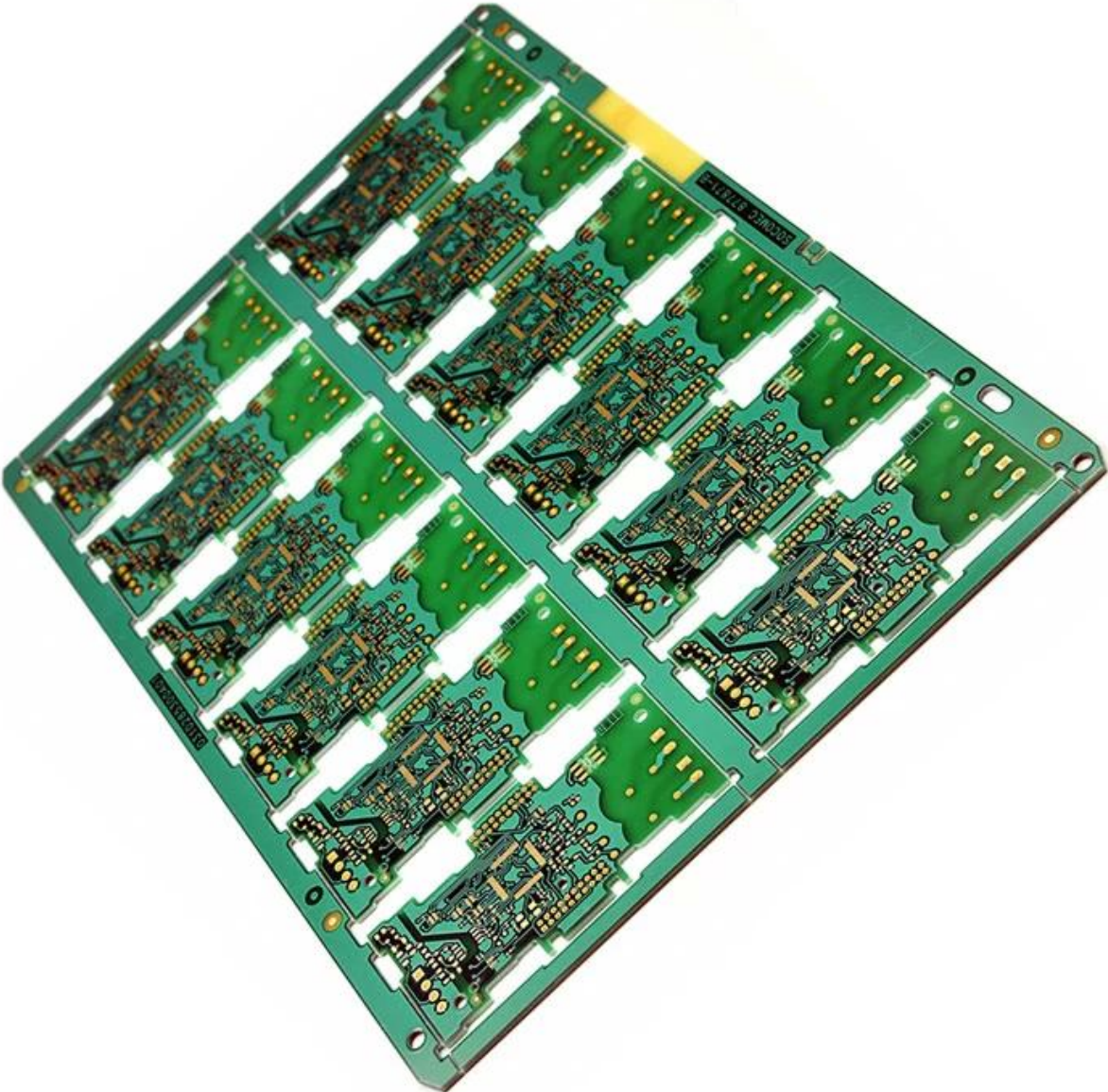

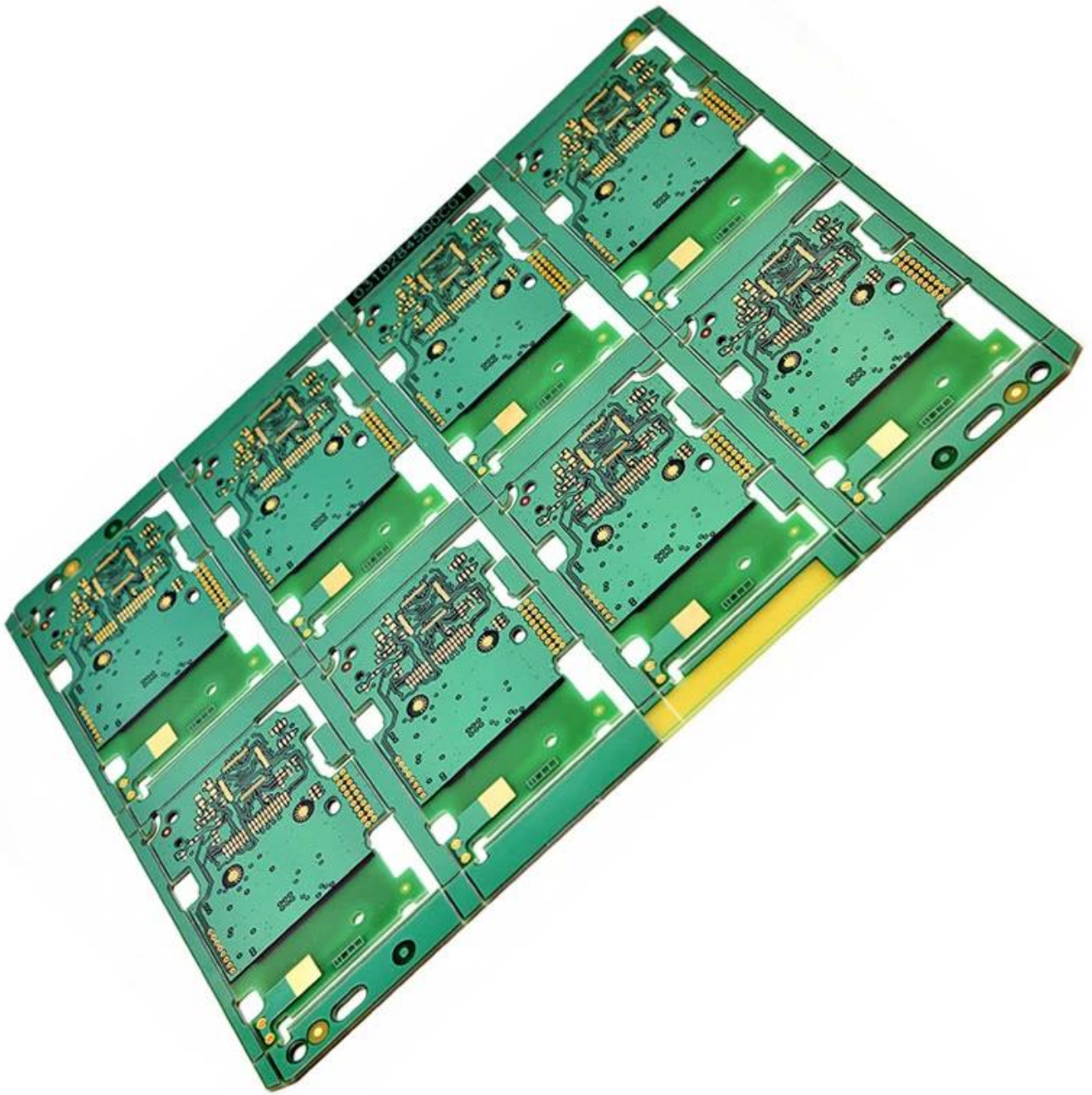

TOP QUALITY PCBA

O-LEADING

To Be Reliable, To Be Valuable



MAKE YOUR IDEA COME **TRUE**

TOP QUALITY PCBA

O-LEADING

To Be Reliable, To Be Valuable

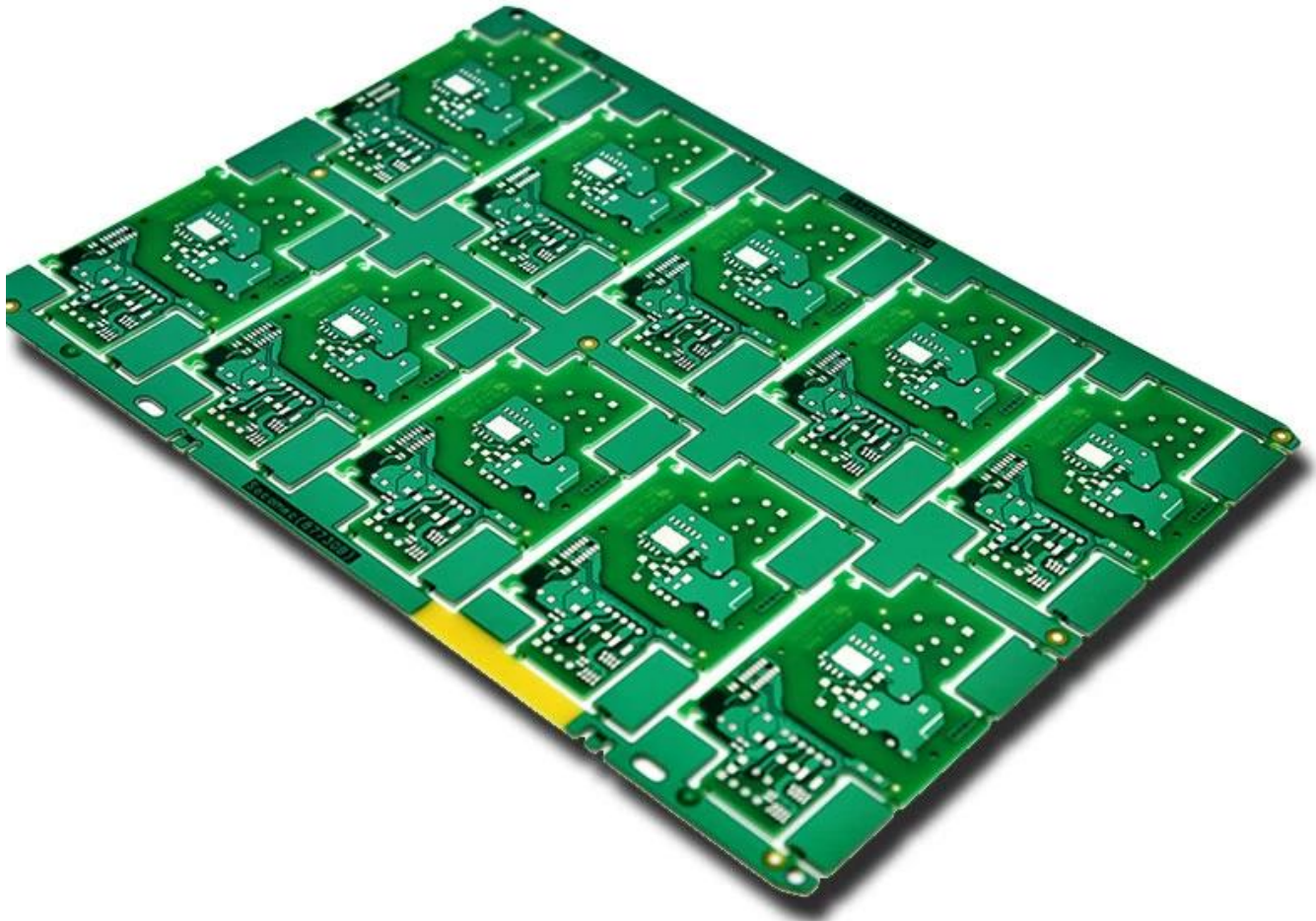

MAKE YOUR IDEA COME **TRUE**

TOP QUALITY PCBA

O-LEADING

To Be Reliable, To Be Valuable

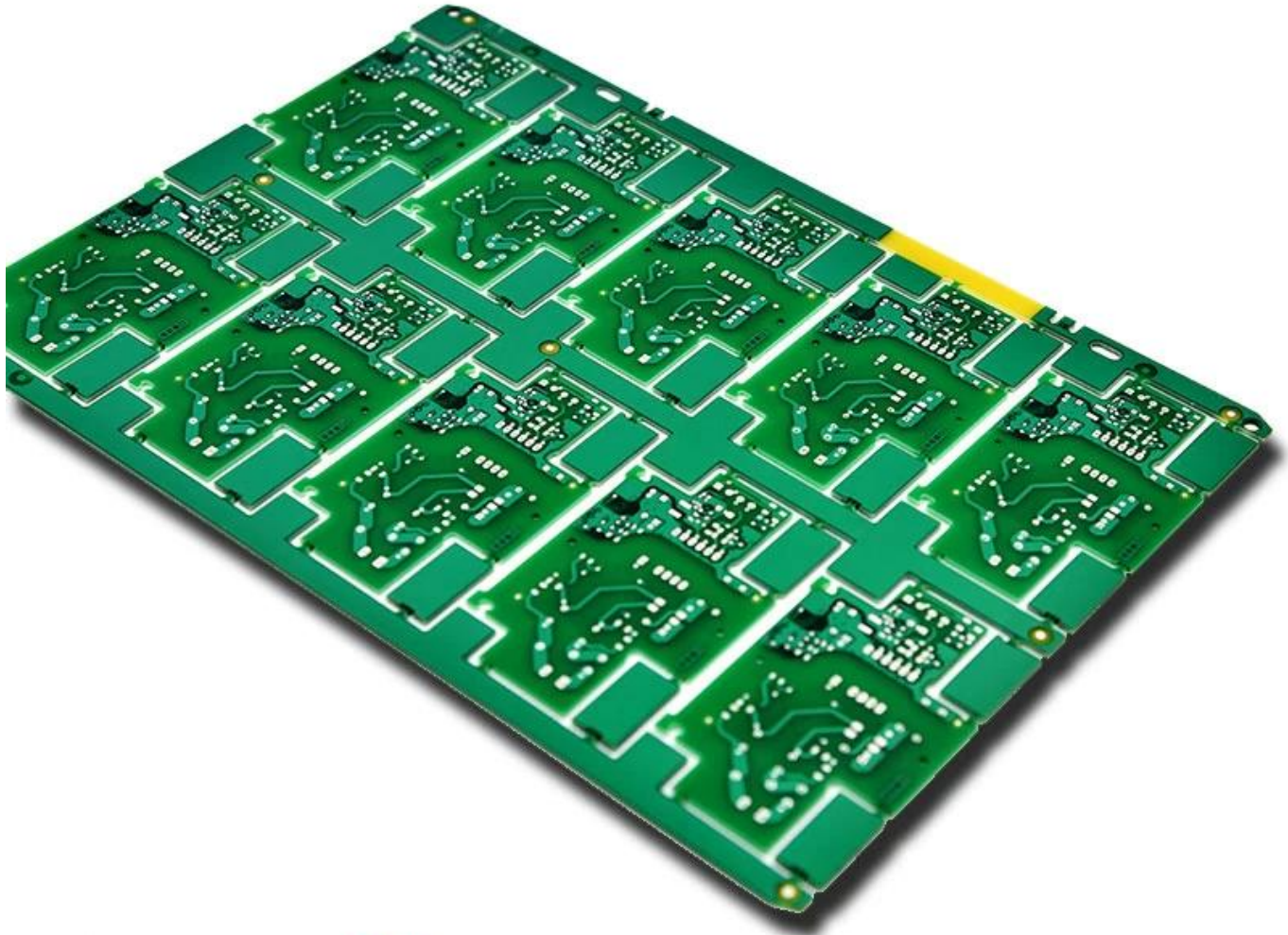

MAKE YOUR IDEA COME **TRUE**

Market Share

 CONSUMER ELECTRONICS

 AUTOMOTIVE ELECTRONICS

 INDUSTRIAL CONTROL

 INTELLECTUALIZED HOUSEHOLD CONTROL

 OTHER



30%
CONSUMER ELECTRONICS



18%
INTELLECTUALIZED HOUSEHOLD CONTROL

20%
AUTOMOTIVE ELECTRONICS



12%
OTHER

20%
INDUSTRIAL CONTROL

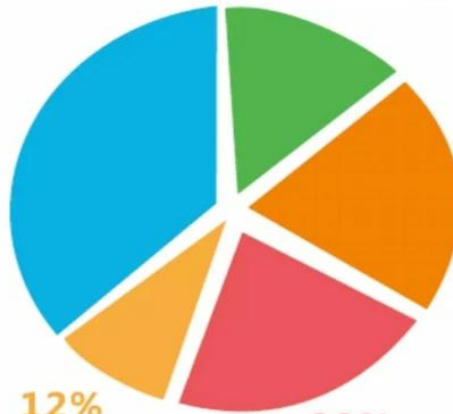

Product types

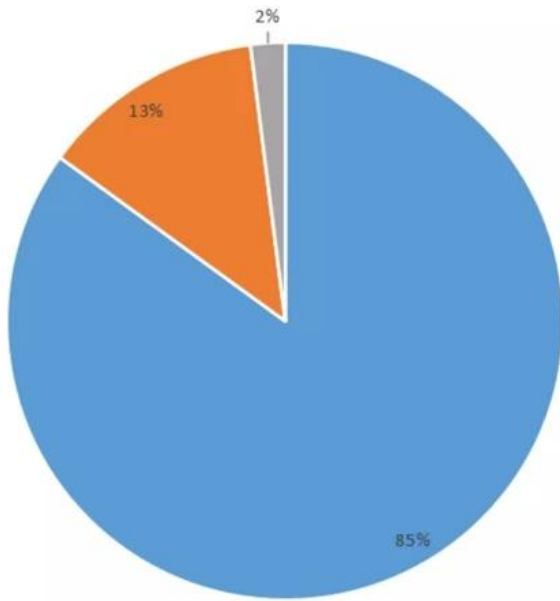

■ FR-4 PCB ■ MC PCB ■ rigid-flexible PCB

Product layers

■ 1L ■ 2L ■ 4L ■ 6L ■ >8L

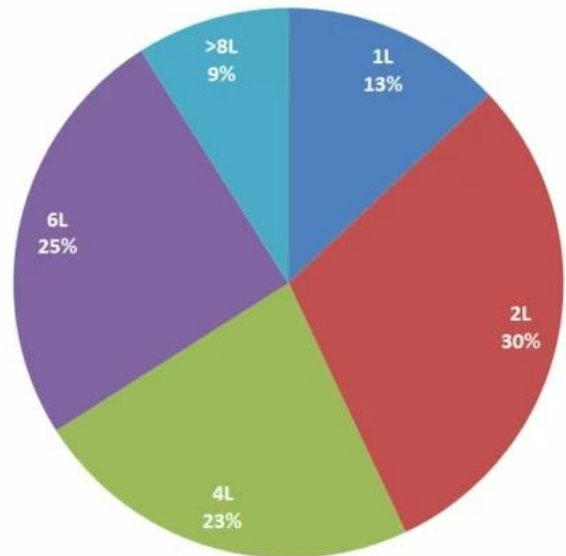

Production Process

18 years experience in one-stop PCB and PCBA, we can make your idea come true,



Notre équipe



Factory PCB



Automatic vacuum press machine



Drilling Machine



Pattern Plating Machine



Scrubbing Machine



Developing Machine



Routing Machine



High-speed flying probe machine



E-test Machine

Factory SMT

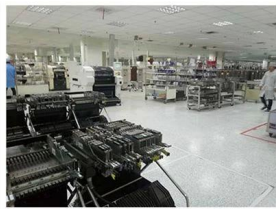

HOW O-LEADING MAKE A PROJECT FOR YOU

Hardware Dispenser Application Not



Automatic Dispenser Application Not

Voltage Table

Volt Pin Number	Description
VDD	Battery Voltage
+3V3	+3.3V
+5V	+5V
USB +5V	USB 5V input
+5V/2	Isolated +5V
+12V	12V DC Drive

STM32F072 PinOUT table

Wire Name	Description	DIO	Mode	Note
SM7N_TOF	Shutdown Time of flight sensor	Output	Logic '1' to shutdown	
I2C_SCL_TOF	I2C communication with time of flight sensor	I2C1_SCL		
I2C_SDA_TOF	I2C communication with thermopile sensor	I2C1_SDA		
I2C_SCL_IR	I2C communication with load cell control pins	I2C2_SCL		
I2C_SDA_IR		I2C2_SDA		
RATE_IC		Output		
DOUT_IC		Output		

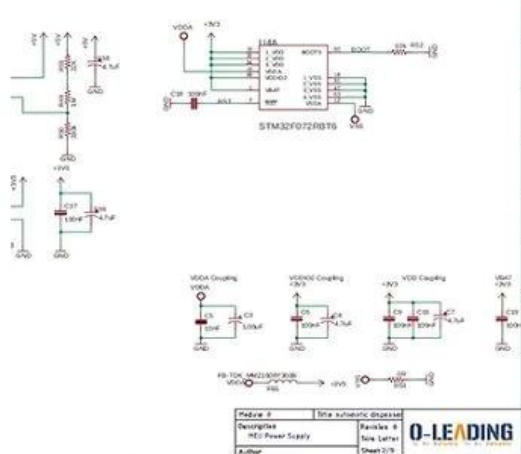

HARDWARE schematics

PCB PRODUCTION COMPONENTS SOURCING

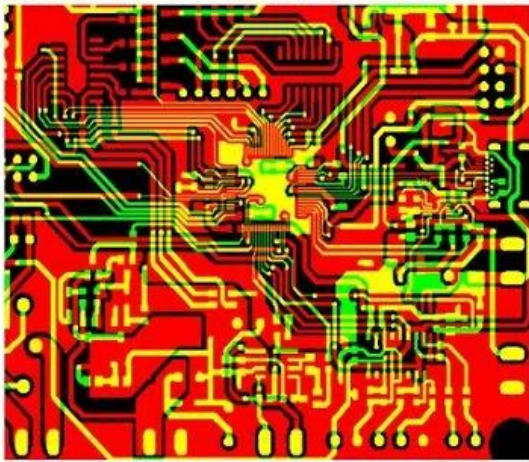

Qty	Value	Device	Parts	Description
4	AK500/1	AK500/2	X1, X2	CONNECTOR
1	AK500/1	AK500/3	X7	CONNECTOR
1	124114	MA04-2	SV2	
1	PPPC04	MA04-2	SV1	8 POS , 4*2 FEMALE PIN HEADE
1	ML10	ML10	SV4	HARTING
1	8MHZ	XTALL_CSTCE8M	X5	STCE8M00G52-R0 RESONATOR
1	0R	R-0603	R53	Thick Film Resistors - SMD 0603
2	10R	R-0603	R12, R5	Thick Film Resistors - SMD 0603
8	100R	R-0603	R1, R2	Thick Film Resistors - SMD 0603
1	270R	R-0805	R15	Thick Film Resistors - SMD 0605
1	330R	R-0603	R11	Thick Film Resistors - SMD 0603
9	680R	R-0603	R20, R3	Thick Film Resistors - SMD 0603
17	1k	R-0603	R9, R10	Thick Film Resistors - SMD 0603
2	4.7k	R-0603	R17, R6	Thick Film Resistors - SMD 0603
2	5.1k	R-0603	R18, R7	Thick Film Resistors - SMD 0603
9	10k	R-0603	R16, R3	Thick Film Resistors - SMD 0603

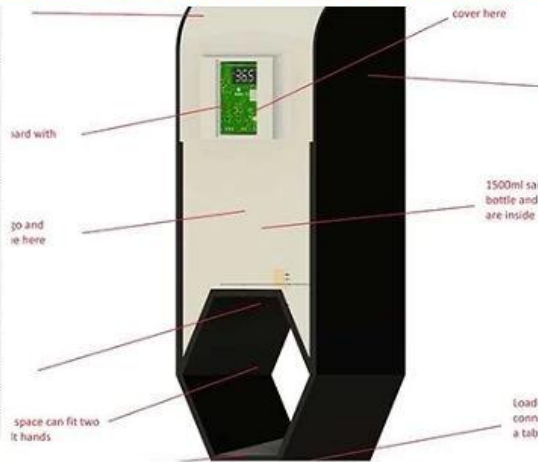
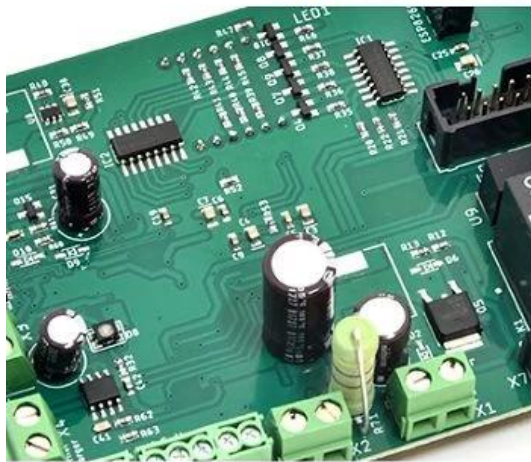

PCB Assembly MECHANICAL DESIGN

O-LEADING CUSTOMER

To be **RELIABLE**

- Q**uality first ,
- C**ustomer supreme ,
- S**cientifically management ,
- S**triving for famous brand



THE CUSTOMER IS KING



To be **VALUABLE**

- S**cience and technology keeps head ,
- P**ut people first ,
- B**e precise and practical ,
- C**ontribute sincerely

Skyworth 创维

HET 和而泰
HET INTELLIGENT CONTROL

dongweikeji
东威科技

美的 Midea

STAR-NET
星网锐捷

FORYOU
ADAYO 华阳集团

EDIFIER[®]

Cultraview 金锐显

3nod 三诺

T&W

TCL

AcBel 康舒科技
ACBEL POLYTECH INC.

Honeywell

Schneider
Electric

ZTE 中兴

EMERSON

BYD

PHILIPS

TE
connectivity

VIDEOTON

CUSTOMER VOICE IS **EXTREMELY IMPORTANT TO US**

订单编号: 49335463501024670

供应商服务: 非常满意 (5 stars) 按时发货: 非常满意 (5 stars)



High quality usb power pcb , pcba manufacturer

★★★★★

Fancy has done an excellent job, whenever we write, she answered us within 1 second, O-leading is very perfect with fast delivery, fast logistics, the most important thing is good quality, good packaging, thank you!

[回复该评论](#)



oem customized rohs pcb drawing schematic s...

★★★★★

We received the boards, the quality is very good, the price is very reasonable, Fancy is very nice & smart & experienced, the logistics is super fast, I will come to see more in the future.

[回复该评论](#)

订单编号: 490224962001024670

供应商服务: 非常满意 (5 stars) 按时发货: 非常满意 (5 stars)



High TG180 FR-4 Circuit HDI PCB 94V0 Board...

★★★★★

This is a very efficient PCB design, but we are lucky to find O-leading to support the PCB for us, very good to a PCB supplier.



universal FR4 Multilayer PCB washing machine...

★★★★★

Fancy gives us very excellent service, very professional and experienced, O-leading is the best one of our suppliers, very happy to work with them.

订单编号: 49298271001024670

供应商服务: 非常满意 (5 stars) 按时发货: 非常满意 (5 stars)



High TG180 FR-4 Circuit HDI PCB 94V0 Board ...

★★★★★

perfect product, perfect PCB supplier!

[回复该评论](#)



oem customized rohs pcb drawing schematic s...

★★★★★

Very good and professional PCB product as usual!

[回复该评论](#)



Strip LED Aluminum FR-4 lighting PCB board 9...

★★★★★

High quality, fast delivery, good service, competitive price, lucky and happy to purchase from O-leading!

[回复该评论](#)

订单编号: 4093862201024670

供应商服务: 非常满意 (5 stars) 按时发货: 非常满意 (5 stars)



High quality Keyboard pcb & pcba Factory SMT...

★★★★★

Top quality, it's the right choice to choose O-leading to make the PCB & PCBA

[回复该评论](#)



Professional Printed Circuit Board Manufactur...

★★★★★

Very high quality PCB products, O-leading is the best PCB supplier that we have ever worked with.

订单编号: 44068794501024670

供应商服务: 非常满意 (5 stars) 按时发货: 非常满意 (5 stars)



High TG180 FR-4 Circuit HDI PCB 94V0 Board ...

★★★★★

We bought two batches, one by DHL, the other one by air, good quality and fast delivery!

LISTEN TO **CUSTOMER VOICE**

订单编号: 40903347501024670

供应商服务: 非常满意 (5 stars) 按时发货: 非常满意 (5 stars)



Strip LED Aluminum FR-4 lighting PCB board 9...

★★★★★

Very fast delivery! Fantastic, good job!!!



Professional Printed Circuit Board Manufactur...

★★★★★

Very happy to great support from O-leading, they are not only professional on the PCB, but also provide good PCB products, very good supplier!

订单编号: 36919647001024670

供应商服务: 非常满意 (5 stars) 按时发货: 非常满意 (5 stars)



AML-S802 Quad-core Android embedded boar...

★★★★★

Good products



Fast delivery low cost pcb fabrication O-leadin...

★★★★★

Good supplier

订单编号: 37378603001024670

供应商服务: 非常满意 (5 stars) 按时发货: 非常满意 (5 stars)



hot sale rigid-flexible PCB with 0.2mm BGA an...

★★★★★

very professional supplier



High Quality custom FPCB/Flex PCB/FPC/Flexi...

★★★★★

Good product



OEM ODM PCBA Bluetooth Wireless Marking G...

★★★★★

high soldering quality



Electronic parts haptic pcba Circuit Board asse...

★★★★★

Very Good product

订单编号: 37378603001024670

供应商服务: 非常满意 (5 stars) 按时发货: 非常满意 (5 stars)



Lidar IR Sensor board pcba(H08R6x)

★★★★★

perfect product



Customized PCBA design PCB design

★★★★★

perfect



Audio Speaker and Headphone Jack (H07R3x)

★★★★★

High quality, good

订单编号: 37378603001024670

供应商服务: 非常满意 (5 stars) 按时发货: 非常满意 (5 stars)



Raspberry pi 0 Zero Raspberry Pi Zero PI W ver...

★★★★★

Fantastic products!!



double layer pcb with red S/M and LF-HASL su...

★★★★★

Good!

订单编号: 37378603001024670

供应商服务: 非常满意 (5 stars) 按时发货: 非常满意 (5 stars)



half hole pcb, half hole pcb module, half hole m...

★★★★★

Top half hole pcb supplier, very perfect goods



High Quality custom FPCB/Flex PCB/FPC/Flexi...

★★★★★

this rigid-flexible pcb quality is perfect!



Electronic parts haptic pcba Circuit Board asse...

★★★★★

Very satisfied with O-leading products and quality, especially their on-time delivery, fantastic!

**Be kind to your client,
because he has many choices,
but he chooses you instead.**

Certifications

CICC INSPECTION CERTIFICATION



嘉泰认证

QUALITY MANAGEMENT SYSTEM CERTIFICATE

Certificate No: 18118Q10347R05

We hereby certify that

O-LEADING SUPPLY CHAIN(HK) CO.,LIMITED
 Credit No: 61691591-000-07-18-7
 Registration Add: FLAT/RM 1205 12/F TAI SANG BANK BUILDING 130-132 DES
 VOEUS BOAD CENTRAL HK
 Business Add: 1313, Floor 13, Fortune Building, Danshui Town, Huiyang
 District, Huizhou, Guangdong, China

Has implemented and maintains a **Quality Management System**
 Which fulfils the requirements of the following standards
GB/T19001-2016 idt ISO9001:2015

Scope of certification
 Sales of printed circuit boards

Initial issuance period: February 27, 2018
 Renewal date: April 22, 2019

This certificate is valid during: April 22, 2019 ~ February 26, 2021
 This certificate is invalid without CICC qualified label in the following period

First supervision and audit	Second supervision and audit	Qualified mark
-----------------------------	------------------------------	----------------

The certification implementation scope does not include those production services which shall be obtained by the relevant effective administrative procedures and qualification procedures regulated by the state.
 The effectiveness of this certificate shall be notified by annual surveillance audits of CICC. The certificate shall be valid also only together with the surveillance audit certificate.
 The initial information of this certificate can be searched at the portal of CICC: www.cicc.com.cn
 In the case of changes see clause 8.1.2.





CICC INSPECTION CERTIFICATION



嘉泰认证

质量管理体系认证证书

证书号: 18118Q10347R05

兹证明

诚领供应链(香港)有限公司
 统一社会信用代码: 61691591-000-07-18-7
 注册地址: 香港中環德輔道中 130-132 號大生銀行大廈 1205 室
 经营地址: 广东惠州惠阳淡水南亨西路财富大厦 13 楼 1313

建立的质量管理体系符合
GB/T19001-2016 idt ISO9001:2015 质量标准适用条款的要求

认证范围
 印刷线路板的销售

初次发证日期: 2018年02月27日
 换证日期: 2019年04月22日
 证书有效期: 自2019年04月22日至2021年02月26日
 在下列期限内, 未经 CICC 黏贴合格标贴, 本证书无效

第一次监审	第二次监审	粘标处
-------	-------	-----

本证书认证范围不包括未获得有效的国家规定的行政许可、资质许可的产品/服务范围。
 本证书通过CICC定期监督审核保持, 与年度《保持认证通知书》共同方为有效。
 本证书信息可在国家认监委网站: www.cnca.gov.cn及CICC网站www.cicc.com.cn查询。







Test Report

No. SZXEC1900530401 Date: 30 Mar 2019 Page 1 of 6

O-LEADING SUPPLY CHAIN (HK) CO., LIMITED
1313.FLOOR 13, FORTUNE BUILDING, DANSHUI TOWN, HUIYANG DISTRICT, HUIZHOU, GUANGDONG, CHINA

The following sample(s) was/were submitted and identified on behalf of the clients as : OSP

SGS Job No.: RP19-005089 - SZ
Date of Sample Received: 22 Mar 2019
Testing Period: 22 Mar 2019 - 30 Mar 2019
Test Requested: Selected test(s) as requested by client.
Test Method: Please refer to next page(s).
Test Results: Please refer to next page(s).

Conclusion: Based on the performed tests on submitted sample(s), the results of Lead, Mercury, Cadmium, Hexavalent chromium, Polybrominated biphenyls (PBBs), Polybrominated diphenyl ethers (PBDEs) and Phthalates such as Bis(2-ethylhexyl) phthalate (DEHP), Butyl benzyl phthalate (BBP), Dibutyl phthalate (DBP), and Diisobutyl phthalate (DIBP) comply with the limits as set by RoHS Directive (EU) 2015/863 amending Annex II to Directive 2011/65/EU.

Signed for and on behalf of
SGS-CSTC Standards Technical Services Co., Ltd. Shenzhen Branch

Tina Fan
Approved Signatory

Red circular seal with Chinese text and SGS logo. Includes disclaimer text and contact information for SGS-CSTC Standards Technical Services Co., Ltd. Shenzhen Branch.

Member of the SGS Group (SGS SA)



Test Report

No. SZXEC1900530401 Date: 30 Mar 2019 Page 2 of 6

Test Results:

Test Part Description:

Specimen No. SN1
SGS Sample ID SZX19-005304.001
Description Green"PCB"

Remarks:

- (1) 1 mg/kg = 1 ppm = 0.0001%
(2) MDL = Method Detection Limit
(3) ND = Not Detected (< MDL)
(4) "-" = Not Regulated

RoHS Directive (EU) 2015/863 amending Annex II to Directive 2011/65/EU

Test Method: With reference to IEC 62321-4:2013+A1:2017, IEC 62321-5:2013, IEC 62321-7-2:2017, IEC 62321-6:2015 and IEC 62321-8:2017, analyzed by ICP-OES, UV-Vis and GC-MS.

Table with 5 columns: Test Item(s), Limit, Unit, MDL, and 027. Lists various substances like Cadmium, Lead, Mercury, Hexavalent Chromium, and various brominated biphenyls with their respective limits and detection methods.

Red circular seal with Chinese text and SGS logo. Includes disclaimer text and contact information for SGS-CSTC Standards Technical Services Co., Ltd. Shenzhen Branch.

Member of the SGS Group (SGS SA)



ZPMV2.E490354 - WIRING, PRINTED - COMPONENT

Wiring, Printed - Component

See General Information for Wiring, Printed - Component

O-LEADING SUPPLY CHAIN (HK) CO LTD

E490354

ROOM 1205, 12/F
TAI SANG BANK BLDG
130-132 DES VOEUS ROAD
CENTRAL, HONG KONG

Type	Cond Width		Cond Thk mic(mil)	SS/ DS/ DSO	Max	Max		Meets UL796	C		
	Min	Edge			Area Diam	Solder Limits	Oper Temp			Flame	
	mm(in)	mm(in)			mm(in)	C	sec	C	Class	DSR	I
Multilayer (mass laminate) printed wiring boards.											
O-LEADING-401	0.1 (0.004)	0.3 (0.012)	34 (1.34)	DS	12.7 (0.5)	260	10	130	V-0	-	-
O-LEADING-407	0.08 (0.003)	0.2 (0.008)	17 (0.67)	DS	9.7 (0.4)	260	10	130	V-0	All	-
Multilayer printed wiring boards.											
O-LEADING-408	0.125 (0.005)	0.125 (0.005)	12 (0.47) Int:136	DS	50.8 (2.0)	280	20	130	V-0	All	*
Single layer printed wiring boards.											
O-LEADING-002	0.38 (0.015)	1.14 (0.045)	34 (1.34)	SS	19.1 (0.8)	260	10	105	V-0	All	-
O-LEADING-003	0.38 (0.015)	1.14 (0.045)	34 (1.34)	SS	19.1 (0.8)	260	10	130	V-0	▲	-
O-LEADING-033	0.15 (0.006)	0.3 (0.012)	34 (1.34)	SS	25.4 (1.0)	260	10	120	V-0	All	-
O-LEADING-205	0.1 (0.004)	0.3 (0.012)	34 (1.34)	DS	69.6 (2.7)	260	10	130	V-0	All	-
O-LEADING-206	0.15 (0.006)	0.33 (0.013)	17 (0.67)	DS	69.6 (2.7)	260	10	130	V-0	All	-
O-LEADING-D01	0.14 (0.006)	0.15 (0.006)	33 (1.30)	DS	25.4 (1.0)	260	10	130	V-0	All	*
O-LEADING-S01	0.25 (0.010)	0.25 (0.010)	17 (0.67)	SS	25.4 (1.0)	260	4	130	V-0	All	*

WIRING, PRINTED - COMPONENT | UL Product iQ

O-LEADING-S02	0.2 (0.008)	0.2 (0.008)	17 (0.67)	SS	25.4 (1.0)	260	4	130	HB	▲	*
O-LEADING-S03	0.25 (0.010)	0.25 (0.010)	34 (1.34)	SS	25.4 (1.0)	260	4	130	V-0	All	*

* - CTI marking is optional and may be marked on the printed wiring board.

Marking: Company name or file number and type designation. May be followed by a suffix to denote factory identification or burning test classification.

并不是所有出现在本数据库中的公司名称和产品都满足了UL跟踪检验服务的要求。只有带有UL标志的产品，才应该被视为经过UL认证，并满足UL跟踪检验服务的要求。注意查看产品上的标志。

UL允许在线认证目录中所含材料的复制遵循以下条件：1.指南信息、装配、构造、设计、系统和/或认证（文件）必须在不篡改任何数据（或图纸）的情况下完整且无误导性地呈现。2.经UL允许从在线认证目录转载“声明必须出现在所摘取材料的邻近位置。此外，转载材料必须包含以下格式的版权声明：“© 2019 UL LLC”

Capacité du processus

Capacités de production de PCB

Nombre de couches	1 couche-32 couche
Épaisseur de cuivre finie	1/3 oz-12 oz
Min Largeur de ligne / espacement interne	3,0 mil / 3,0 mil
Min Largeur de ligne / espacement externe	4,0 mil / 4,0 mil
Rapport hauteur / largeur maximum	10: 1
Épaisseur du panneau	0,2 mm à 5,0 mm
Taille maximale du panneau (pouces)	635 * 1500 mm
Taille minimale du trou percé	4 mil
Tolérance de trou Plated	+/- 3 mil
Blind / Buried Vias (types AII)	OUI
Par remplissage (conducteur, non conducteur)	OUI
Matériel de base	FR-4, FR-4high Tg Matériau sans halogène, Rogers, base en aluminium, Polyimide, cuivre lourd
Finitions de surface	HASL, OSP, ENIG, HAL-LF, Immersion argent, Immersion étain, doigts d'or, encre de carbone

Capacités de production SMT

Matériel PCB	FR-4, CEM-1, CEM-3, panneau à base d'aluminium, FPC
Taille maximale du PCB	510 x 1 500 mm
Taille minimale du PCB	50 x 50 mm
Épaisseur de PCB	0,5 mm à 4,5 mm
Épaisseur du panneau	0,5 à 4 mm
Taille minimale des composants	0201
Composant de taille de puce standard	0603 et plus
Hauteur max du composant	15 mm
Pas de plomb minimum	0,3 mm
Pas de balle min BGA	0,4 mm
Précision de placement	+/- 0,03 mm

Emballage et livraison

Shipping service



Quick Turn Lead Time		
Layer Count:	Lead Tim	Special Requirement
1L/2L	2-3days	24 Hours,48 Hours
4L	3-4days	48 Hours
6L	4-5days	72 Hours
8L	5-6days	NA
10L	6-7days	NA
12L	7-8days	NA
14L	8-9days	NA

Standard Lead Time		
Layer Count:	Sample Lead Time	Volume order lead time
2L	4 days	10 days
4L	5 days	11 days
6L	6 days	12 days
8L	8 days	14 days
10L	10 days	16 days
12L	12 days	18 days
14L	14 days	20 days
16-32L	18 days	24 days

FAQ

1. Comment O-Leading assure-t-il la qualité? Notre standard de qualité élevé est atteint avec ce qui suit.

- 1.1 Le processus est strictement contrôlé selon les normes ISO 9001: 2008.
- 1.2 Utilisation étendue de logiciels dans la gestion du processus de production
- 1.3 Équipements et outils de test de pointe. Par exemple. Sonde volante, inspection aux rayons X, AOI (Automated Optical Inspector) et ICT (test in-circuit).
- 1.4 Équipe d'assurance qualité dédiée avec processus d'analyse des cas de défaillance
- 1.5 Formation et éducation continue du personnel

2. Comment O-Leading maintient-il votre prix compétitif?

Au cours de la dernière décennie, les prix de nombreuses matières premières (par exemple le cuivre, les produits chimiques) ont doublé, triplé ou quadruplé; Le RMB en devise chinoise s'est apprécié de 31% par rapport au dollar américain; Et nos coûts de main-d'œuvre ont également augmenté de manière significative.

Cependant, O-Leading a maintenu nos prix stables. Cela dépend entièrement de nos innovations en matière de réduction des coûts, d'évitement des déchets et d'amélioration de l'efficacité. Nos prix sont très compétitifs dans l'industrie au même niveau de qualité.

Nous croyons en un partenariat gagnant-gagnant avec nos clients. Notre partenariat sera mutuellement avantageux si nous pouvons vous fournir un coût et une qualité anedgeon.

3. Quels types de tableaux peuvent être traités par O-Leading?

Cartes courantes FR4, à haute TG et sans halogène, Rogers, Arlon, Telfon, cartes à base d'aluminium / cuivre, PI, etc.

4. Quelles données sont nécessaires pour la production de PCB et PCBA?

4.1 Nomenclature (Nomenclature) avec désignations de référence: description des composants, nom du fabricant et numéro de pièce.

4.2 Fichiers Gerber PCB.

4.3 Dessin de fabrication de PCB et dessin d'assemblage de PCBA.

4.4 Procédures d'essai.

4.5 Toutes restrictions mécaniques telles que les exigences de hauteur d'assemblage.

5. Quel est le flux de processus typique pour les PCB multicouches?

Découpe du matériau → Film sec interne → gravure interne → AOI interne → Multi-bond → Empilement de couches Pressage → Perçage → PTH → Placage de panneau → Film sec externe → Placage de motif → Gravure externe → AOI externe → Masque de soudure → Marque de composant → Finition de surface → Routage → E / T → Contrôle visuel.

6. Quels sont les équipements clés pour la fabrication HDI?

La liste des équipements clés est la suivante: perceuse laser, machine de pressage, ligne VCP, machine d'exposition automatique, LDI et etc. Les équipements que nous avons sont les meilleurs de l'industrie, les machines de forage laser sont de Mitsubishi et Hitachi, les machines LDI sont de Screen (Japon), les machines d'exposition automatiques sont également de Hitachi, elles permettent toutes de répondre aux exigences techniques du client.

7. Combien de types de finition de surface O-plomb peuvent faire?

O-the leader a la série complète de finitions de surface, telles que: ENIG, OSP, LF-HASL, placage d'or (doux / dur), argent d'immersion, étain, placage d'argent, placage d'étain par immersion, encre de carbone, etc. OSP, ENIG, OSP + ENIG couramment utilisés sur le HDI, nous vous recommandons généralement d'utiliser un client ou OSP OSP + ENIG si la taille du BGA PAD est inférieure à 0,3 mm.

8. Quelle est votre capacité pour FPC? O-Leading peut-il également fournir un service SMT?

O-Leading peut fabriquer des FPC d'une seule couche à 8 couches, la taille du panneau de travail peut être aussi grande que 2000 mm * 240 mm, veuillez trouver les détails dans la page «Flex Capability». Nous fournissons également un service SMT à guichet unique au client.

9. Quels sont les principaux facteurs qui affecteront le prix du PCB?

Matériel;

Finition de surface;

Difficulté technologique;

Différents critères de qualité;

Caractéristiques des PCB;

Modalités de paiement;

Différents pays de fabrication.

10. Quelle est la définition des PCB, PWB et FPC et quelle est la différence?

PCB est l'abréviation de Circuit imprimé;

PWB est l'abréviation de Printed Wire Board, au même sens que Printed Circuit Board;

FPC est l'abréviation de Flexible Printed Board.

11. Quels facteurs faut-il prendre en compte lors du choix du matériau pour une carte PCB?

Les facteurs ci-dessous doivent être pris en compte lorsque nous choisissons le matériau pour PCB:

La valeur Tg du matériau doit être supérieure à la température de fonctionnement;

Le matériau à faible CTE a de bonnes performances de stabilité thermique;

Bonnes performances de résistance thermique: Normalement, les circuits imprimés doivent résister à 250 °C pendant au moins 50 s.

Bonne planéité; Compte tenu des propriétés électriques, un matériau à faible perte / haute permittivité est utilisé sur les circuits imprimés haute fréquence;

Substrat en fibre de verre polyimide utilisé pour les circuits imprimés flexibles; Le noyau métallique est utilisé lorsque le produit a une exigence stricte de chaleur dissipation.

12. Quels sont les avantages du PCB rigide-flex d'O-Leading?

Le PCB rigide-flex de O-Leading a les caractères FPC et PCB, il peut donc être utilisé dans certains produits spéciaux. Une partie est flexible tandis que l'autre est rigide, elle peut aider à économiser l'espace intérieur du produit, à réduire le volume du produit et à améliorer les performances.

13. Comment faire le calcul de l'impédance?

Le système de contrôle d'impédance se fait à l'aide de quelques coupons de test, du logiciel SI6000 et de l'équipement CITS 500s de POLAR INSTRUMENTS. L'équipement mesure l'impédance sur un coupon de configuration de piste représentatif dont le client nous a donné une valeur et une tolérance déterminées.