

Tuotteen Kuvaus

Kotitalouksien kosketusvapaa käsien desinfiointilaite sähköinen vaahtosuihku Automaattinen infrapuna-anturisaippua-annostelija käsivaahdesuihke hotelli

Sovellus: HOTEL, huvila, ASUNTO, TOIMISTORAKENNUS, SAIRAALA, koulu, ostoskeskus, urheilupaikat, vapaa-ajanviettomahdollisuudet, supermarket, varasto, työpaja, puisto, maalaistalo, piha

tuotteen nimi	Automaattinen käsienvuuhdistusaineen annostelija
Materiaali	ABS + PP
Paino	255G
Kapasiteetti	350ml
Lataus	USB ladattava
Ominaisuus	Automaattinen anturi

**Ominaisuus.**

Automaattinen ja kosketukseton: Tämä vaahtosaippua-annostelija, joka on erityisesti sisäänrakennettu infrapunatunnistin, kädet vapaana, se pitää bakteerit poissa ja auttaa pitämään terveellisenä sinulle ja perheellesi. Lisäksi se tekee käsien pesusta mielenkiintoisemman lapsille!

Turvallisempi perheille / vieraille: Aseta käsien desinfiointiaine annostelijamme, joka on täynnä käsien desinfiointigeeliä, oveen, anna perheiden ja vieraiden, jotka lähtevät ostamaan päivittäisiä tarvikkeita, desinfioimaan kätensä ennen sisään tulemistä. Kieltäydy tuomasta virusta kotiin.

MATERIAALI: ABS ympäristöystävällinen likainen materiaali, turvallinen ja korroosionkestävä; infrapuna tarkka ja älykäs tunnistava, vuotamaton kumipistorasia; ei meteliä.

Sopivampi: Tämän käyttäminen [käsien desinfiointigeelisaippua](#) Kaikissa julkisten tilojen sisäänkäynnissä desinfioida kätensä ennen ravintolaan, hotelliin, sairaalaan tulemistä ... Ne ovat täynnä

käsinpuhdistusgeeliä vaahtosaippuan sijasta, joten voit laittaa ne mihin tahansa, koska sinun ei tarvitse pestä käsiäsi vettä.

NEW OPTION FOR CLEANING

AUTOMATIC INDUCTION HAND-WASHING MACHINE

The essence of natural plants
nourishes and cares for your hands
Contact-free, More at ease



Hand-washing machine x 1
Antibacterial effervescent tablets x 1

INTELLIGENT TECHNOLOGY IMPROVE YOUR QUALITY OF LIFE



Near-field
infrared sensing



Rapid
bubbling



No contact
more hygienic



40 days of
continuous use



Small and free
installation



ABS
Material

**FULLY AUTOMATIC HAND-WASHING MACHINE
CARE FOR THE HEALTH OF THE WHOLE FAMILY**



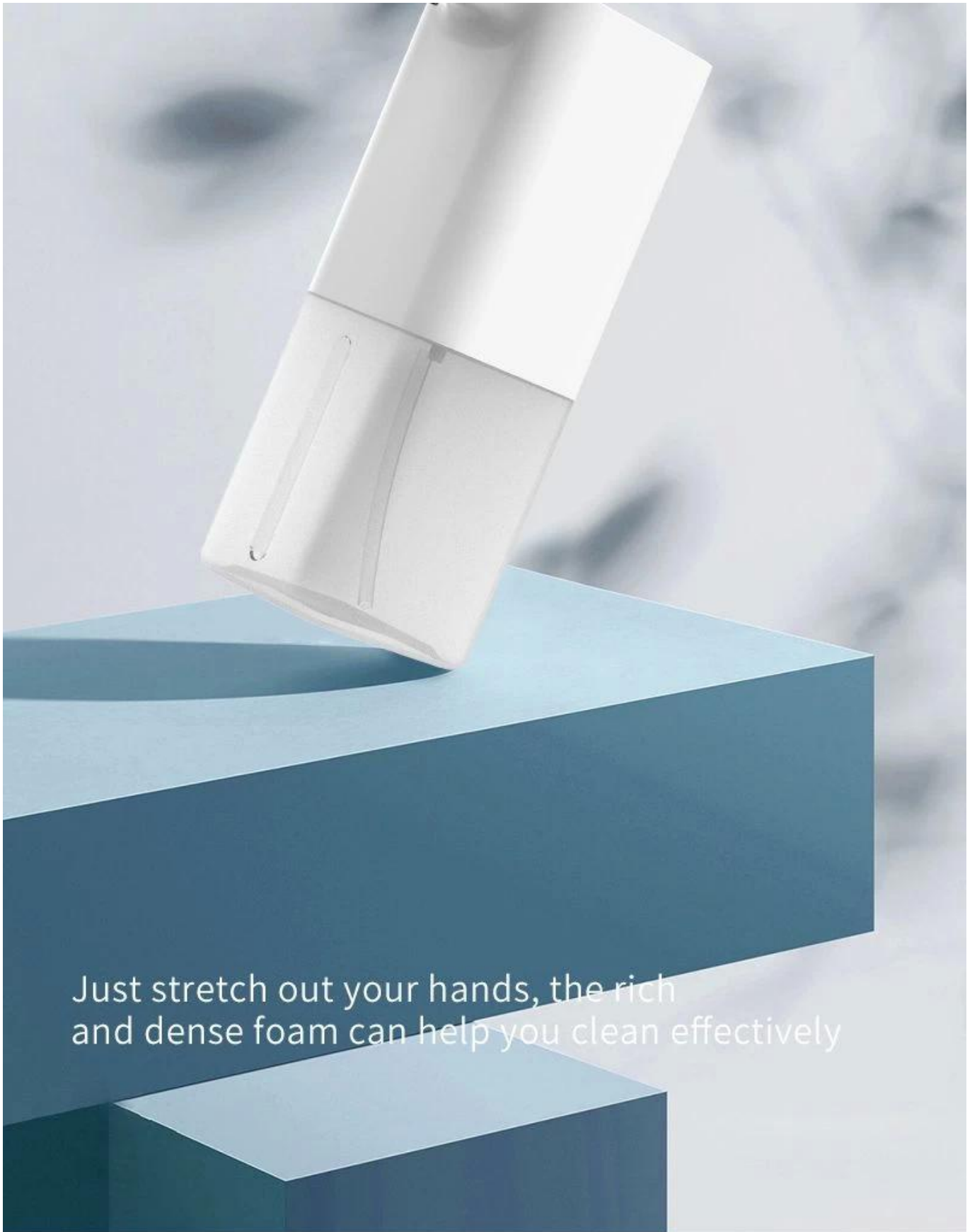

Just stretch out your hands, the rich
and dense foam can help you clean effectively

AUTOMATIC INDUCTION

EFFECTIVELY INHIBIT HARMFUL BACTERIA TAKE CARE OF CHILDREN'S HEALTH

Effectively remove 5 major bacteria
Deeply clean pores
Gentle care for every inch of the child's skin





E.coli



Staphylococcus
aureus



Pseudomonas
aeruginosa



Candida
albicans



salmonella

CHARGING 3 HOURS CAN BE USED CONTINUOUSLY FOR 40 DAYS

Reasonably control the amount of foam
350ml large capacity design
can be used 500 times
to meet the family's 30-day dosage





Near-field
infrared sensing



0.25S Rapid
bubbling

DEEP CLEAN

DENSE AND RICH FOAM PENETRATES INTO PORES FOR DEEP CLEANSING

The dense foam can better cover the skin's epidermis and reach the fine pores for deep cleaning





ONE MACHINE IS VERSATILE LIQUID CAN BE CHANGED FREELY

A replaceable solution bottle at the bottom makes it easy
to inject different hand sanitizers
making it easier to add
various hand sanitizers you have purchased



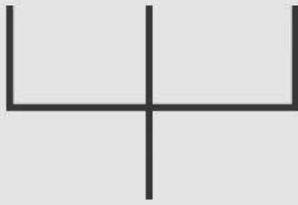

Hand sanitizer 3:7 tap water
Shake evenly to allow
hand soap to penetrate and dilute

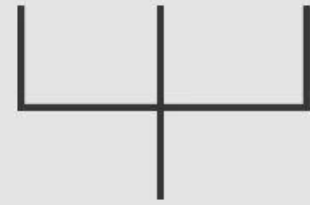

Detergent 3:7 tap water
Shake evenly to allow hand
soap to penetrate and dilute

*Effervescent tablets can be replaced with liquid soap or dishwashing liquid
The ratio is for reference only, the effect of self-provisioning is more suitable

MOISTURIZING FUNCTION

ANTIBACTERIAL MOISTURIZING CLEANSING

Choose a slightly acidic formula
close to the pH of human skin
With moisturizing function
Glycerin made from natural oil, mild texture



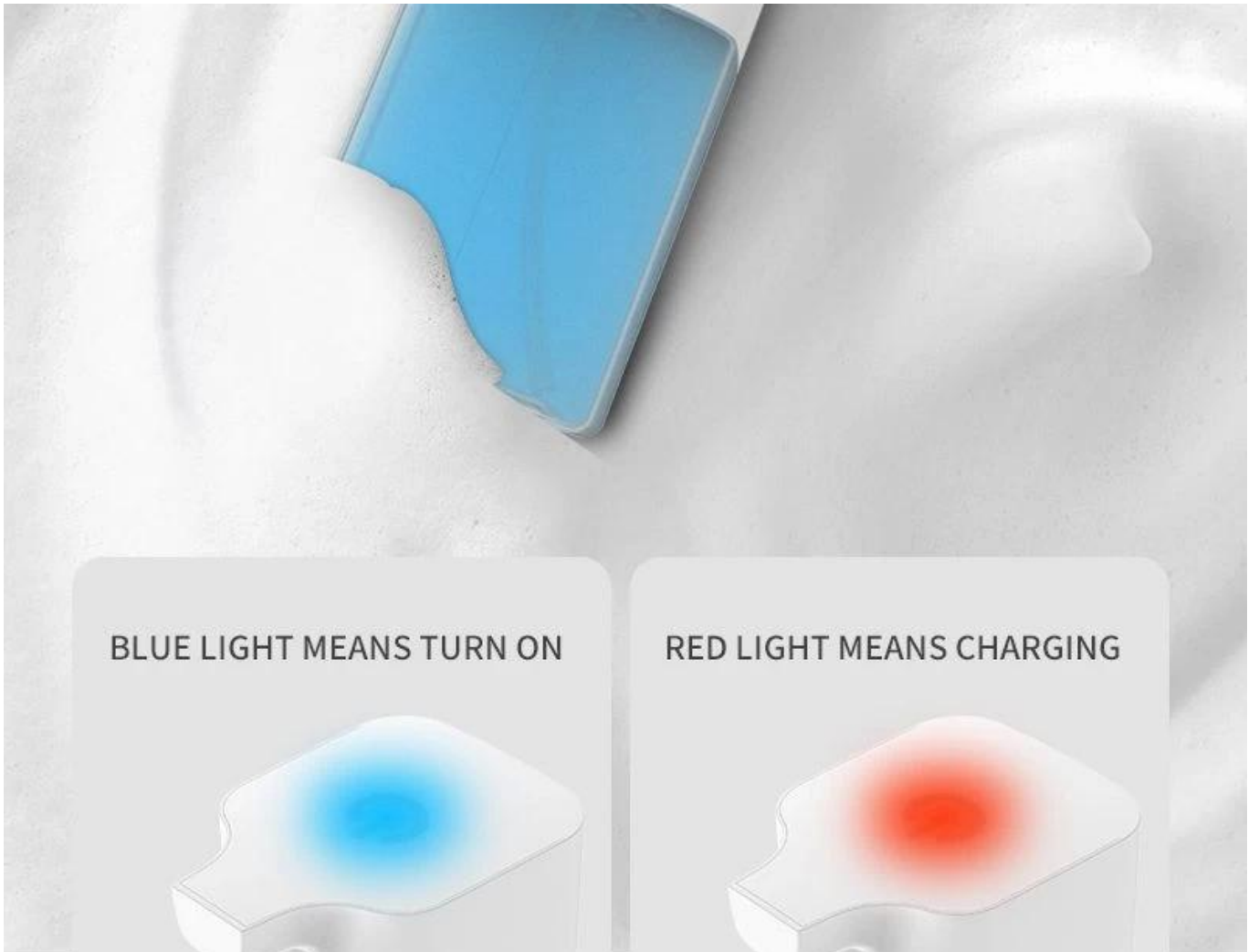

BLUE LIGHT MEANS TURN ON



RED LIGHT MEANS CHARGING



Inhibit bacteria
insist on daily hand washing

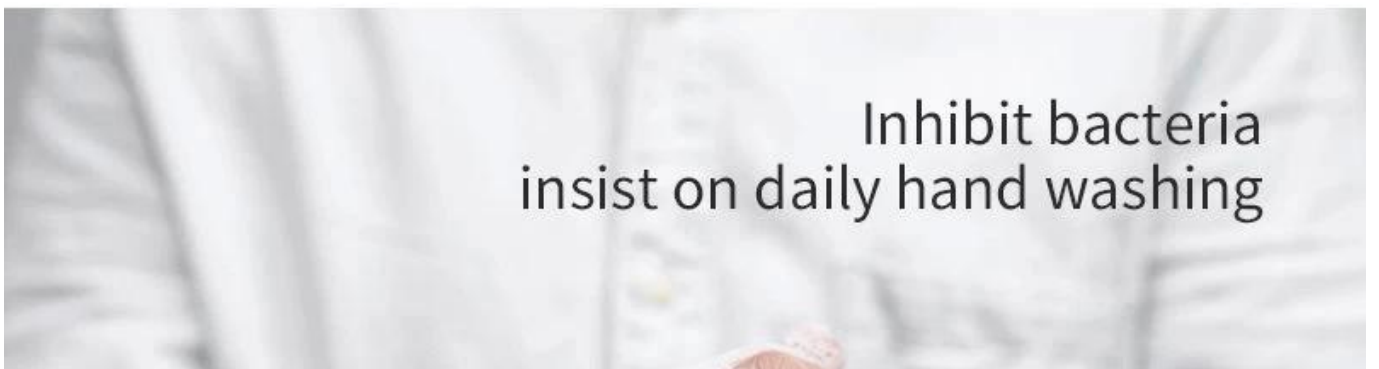



MINIATURE HIGH EFFICIENCY MOTOR LOW POWER CONSUMPTION, QUIETER

The selected miniature high-efficiency motor not only has a high foaming efficiency but also does not disturb the noise during use



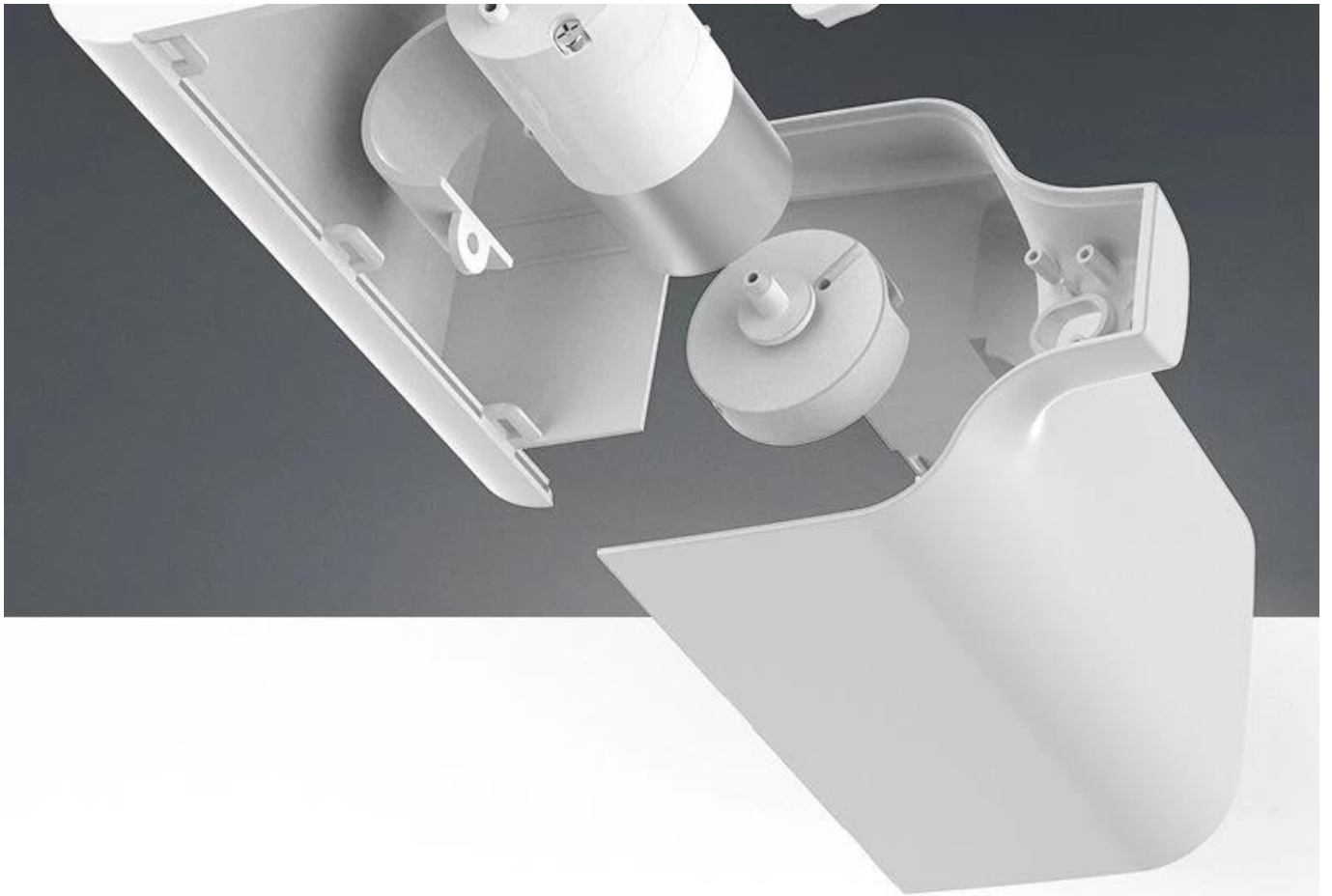

SCANDINAVIAN MINIMALIST DESIGN
SMALL SIZE
SUITABLE FOR VARIOUS ENVIRONMENTS

The bottle of hand sanitizer is made of high-grade frosted material
Clear and clean at any time to check the use of the situation.





PRODUCT INFORMATION

Product Name: Induction foam hand washing machine

Rated voltage: 5V

Rated power: 15W

Capacity: 350ml

Applicable scene:

Material: ABS

Home cleaning, dormitory



PICTURE COLOR IS FOR REFERENCE ONLY
PLEASE REFER TO THE ACTUAL PRODUCT

PRODUCT DETAILS

**TOUCH TO
TURN ON**



**ABS
MATERIAL**

USB CHARGING PORT



INSTALLATION STEPS OF HAND SANITIZER



Remove concentrated effervescent tablets



Break the concentrated effervescent tablet in half



Dilute the concentrated effervescent tablets in a cup



Put the diluted solution in the solution bottle



Tighten the cap and shake gently



After installation you can use

Pakkaus ja toimitus

sähköinen anturi desinfiointilaitteen toimittaja

Pakkausmitta:

60kpl / pakkaus

Pakkauskoko: 8 * 14 * 22cm

Brutto W: 22,5 kg / pakkaus

HS-koodi: 8509809000

Pakkaus ja toimitus

Yksiköiden myynti	Yksi kohde
Yhden pakkauksen koko	8X14X22 cm
Yksi bruttopaino	0,500 kg
Pakkaustyyppi:	30 yksikköä laatikossa Tuotteen koko: 7,5 * 9,7 * 20 cm sisäpakkauksen koko: 8 * 14 * 22cm, 0,35KG Ulkopakkauksen koko: 58 * 42 * 68 cm, GW 22,5 kg

Toimitusaika:

Määrä (yksikköä)	1-100	101-500	501-1000	> 1000
Määrä (yksikköä)	5	7	10	Tulee neuvotella

KuvaEsimerkki:

hotel, KTV and other places

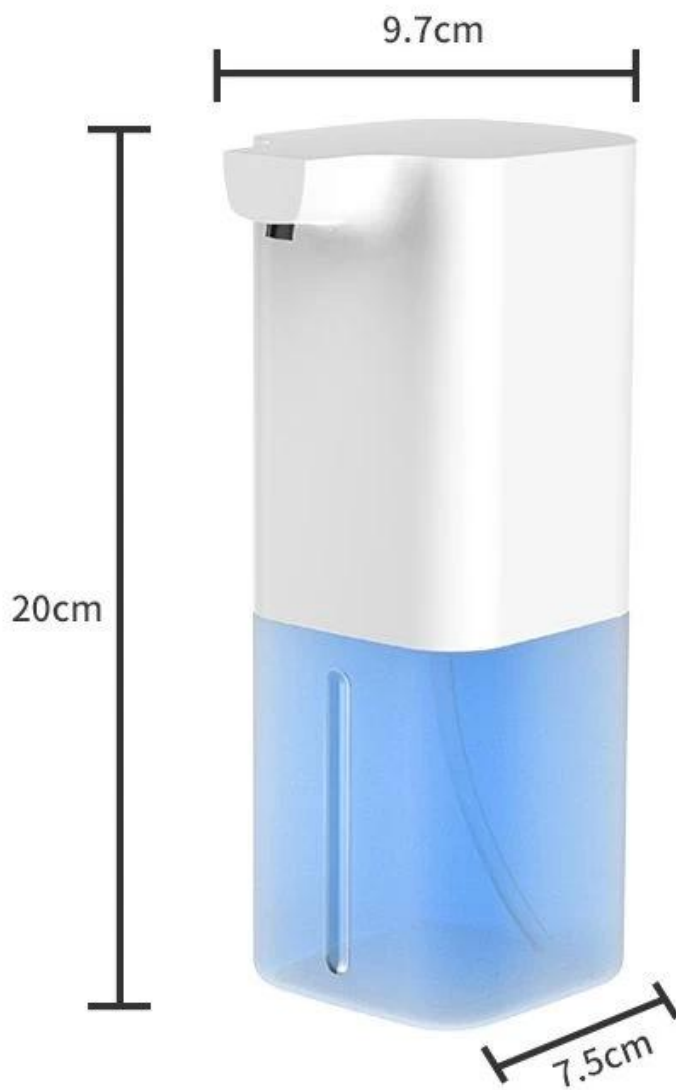

Marine incense

=



Effervescent tablets



MOIST CARE

NORDIC SIMPLE DESIGN

Marine incense/Osmanthus/Rose fragrance/Lemon scent

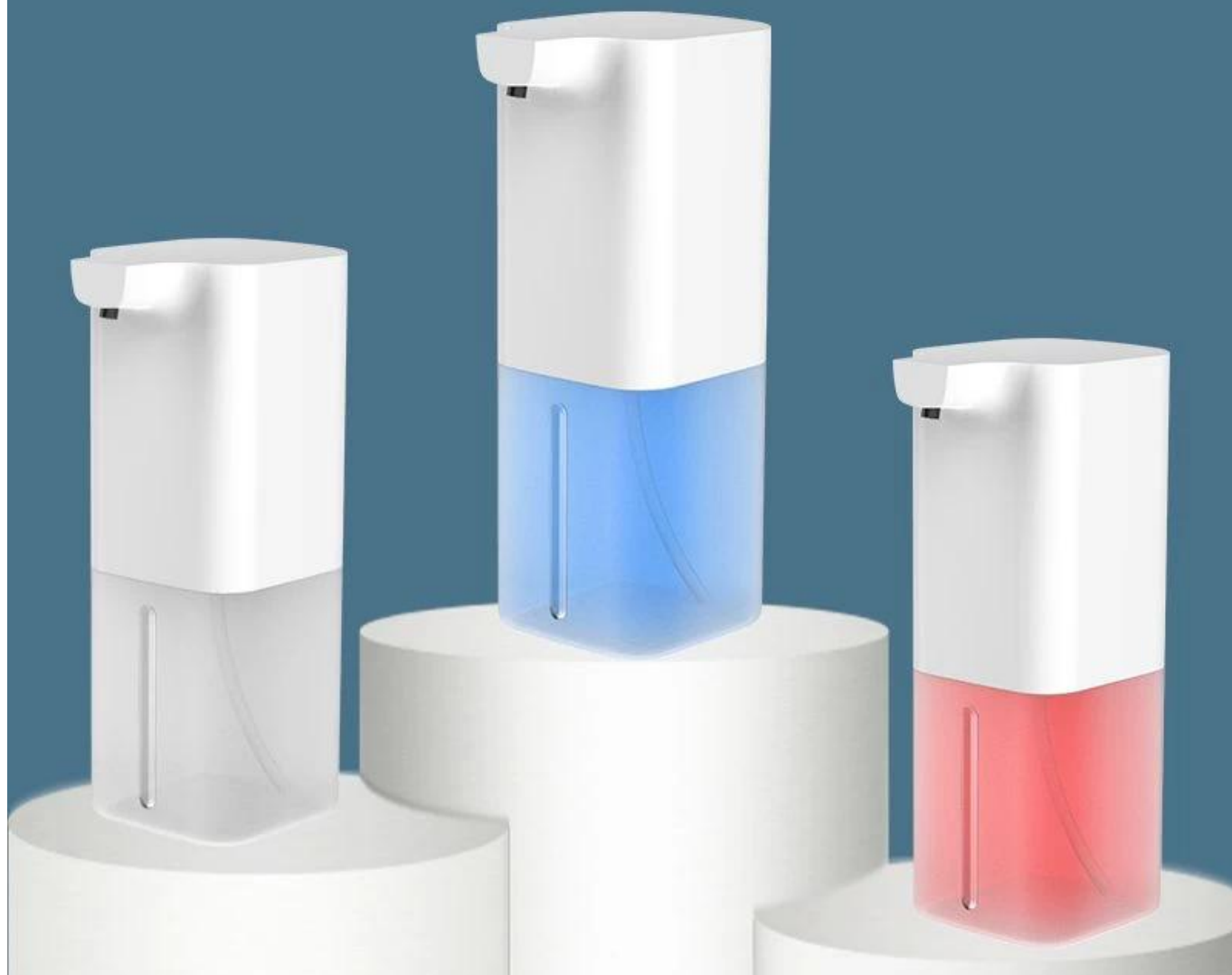

UKK

K: Kuinka saan automaattisen saippua-annostelijan näytteet tarkistamaan laadun?

V: Näyte tilaus on käytettävissä, voidaan lähettää Expressin kautta, saat sen 3-7 päivän kuluessa.

K: Mitä saan hinnan?

V: Tarjoamme yleensä 24 tunnin kuluessa kyselysi saamisesta. Jos haluat saada hinnan erittäin kiireellisesti, kerro meille sähköpostissasi, jotta pidämme kyselyäsi ensisijaisena.

K: Mikä on kaupan toimitusaika?

V: Hyväksymme EXW-, FOB Shenzhen- tai CIF-kohdesataman. Voit valita yhden, joka onsinulle sopivin tai

kustannustehokkain.

K: Entä massatuotannon läpimenoaika?

V: Rehellisesti, se riippuu tilauksen määrästä ja tilauksesta. Näytetilaus on 2 päivän sisällä. OEM / OEM-tilaus vaatii lisää aikaa.