

Bienvenido a O-Leaders

O-Leading se esfuerza por ser su socio de soluciones integrales en la cadena de suministro de EMS, incluido el diseño de PCB, la fabricación de PCB y el ensamblaje de PCB. Ofrecemos algunas de las tecnologías de PCB más avanzadas, incluidas PCB HDI, PCB multicapa, PCB rígido-flexible. Soporte desde el prototipo de giro rápido hasta la producción media y masiva.

En general, nuestros clientes globales están muy impresionados con nuestros servicios: respuesta rápida, precio competitivo y compromiso de calidad. Brindar un servicio técnico más valioso y una solución general es el camino a seguir para O-liderar. ([OEM Proveedor de PCB de Rohs personalizado](#))

Mirando hacia el futuro, O-Leaders se concentrará en la innovación y el desarrollo de la tecnología de fabricación de productos electrónicos como siempre, y hará esfuerzos persistentes en el servicio integral de PCB y PCBA para brindar servicios de primera clase y crear más valor para nuestros clientes.

HAGA CLIC EN ESTOS PARA OBTENER MÁS INFORMACIÓN: [Fabricantes de placas de circuito impreso PCB multicapa OEM](#)



WE ALWAYS PROVIDE YOU
BEST RIGID-FLEXIBLE CIRCUIT



WE ALWAYS PROVIDE YOU

BEST HIGH DENSITY INTERCONNECT PCB





Keep **LEARNING**

There's a phrase in Buddhism, 'Beginner's mind.'

It's wonderful to have a beginner's mind

WE HAVE A **DREAM**

Keep **RUNNING**

I would like to live to study and not study to live.

---Bacon

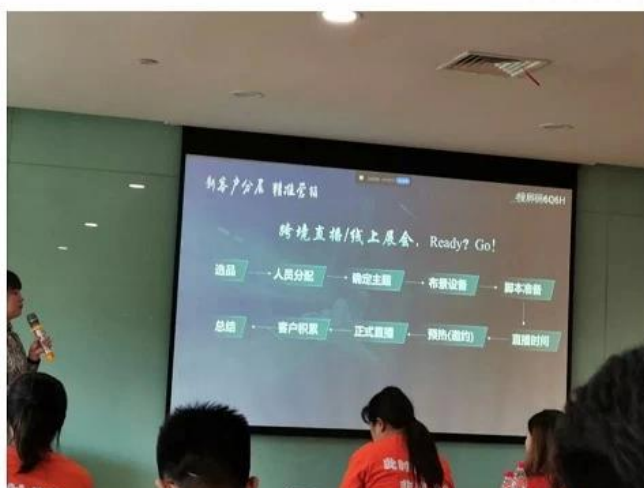

Descripción del producto

OEM Multicapa PCB Board Service PCBA Fabricación Diseño Teclado cuadrado Mobil LED Radio Machine PCB Placa de circuito en blanco ([Ensamblaje de PCB de teclado personalizado del fabricante de PCBA](#))

nombre del producto	Placa de circuito impreso
Nombre de la marca	O-líder
Material de base	FR-4 / CEM-1 / CEM-3 / Polyimild / PTFE / Rogers
Espesor de cobre	0.4-2mil (10-50um)
Espesor del tablero	0,2-6 mm
Min. Tamaño del agujero	0,1 mm (4 mil) para HDI / 0,15 mm (6 mil)

Min. Ancho de línea	0,075 mm / 0,075 mm (3 mil / 3 mil)
Min. Espaciado entre líneas	0,003 pulgadas
Acabado de superficies	HASL / OSP / Ag / ENIG / ENEPIG / Plata de inmersión, Estaño

TOP QUALITY PCBA

O-LEADING
To Be Reliable, To Be Valuable

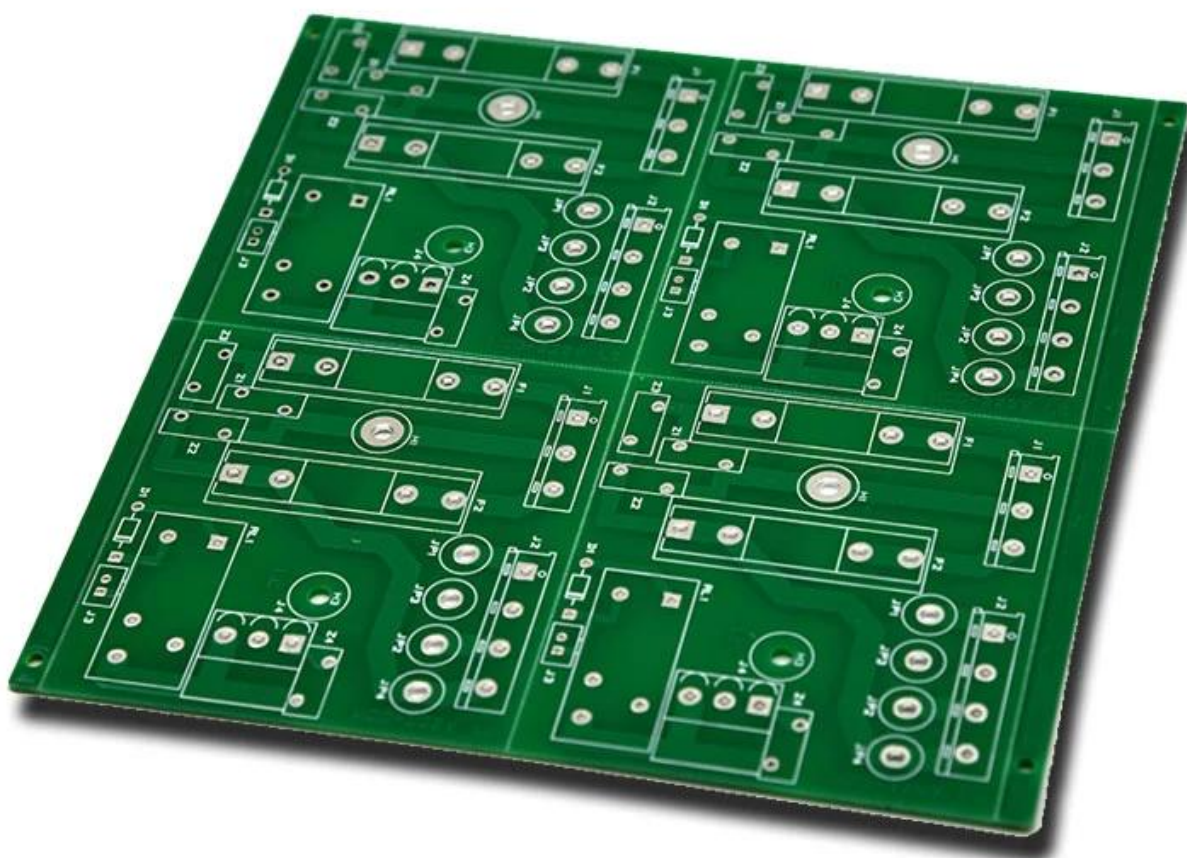

MAKE YOUR IDEA COME **TRUE**

TOP QUALITY PCBA

O-LEADING

To Be Reliable, To Be Valuable

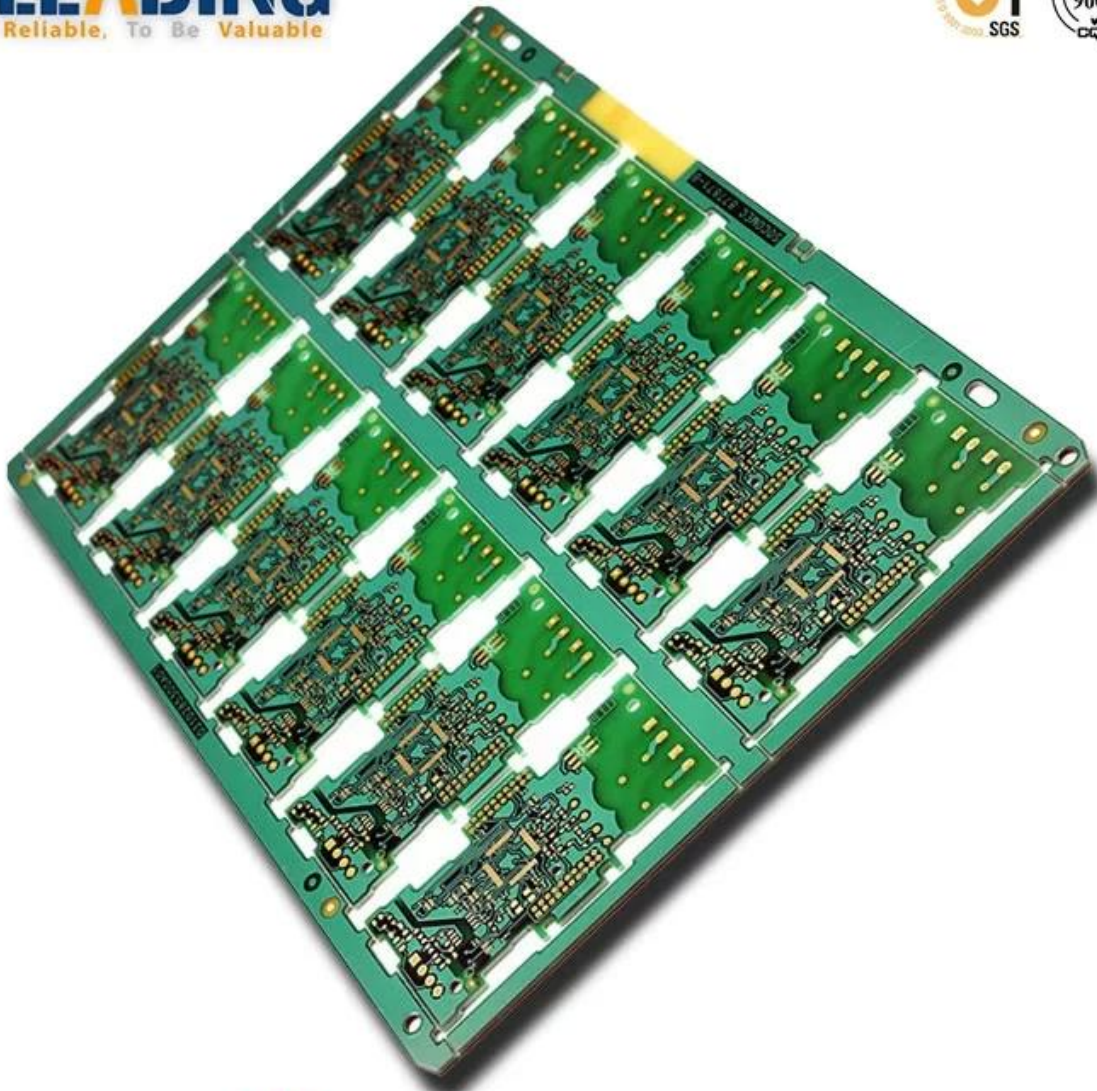

MAKE YOUR IDEA COME TRUE

TOP QUALITY PCBA

O-LEADING

To Be **Reliable**, To Be **Valuable**

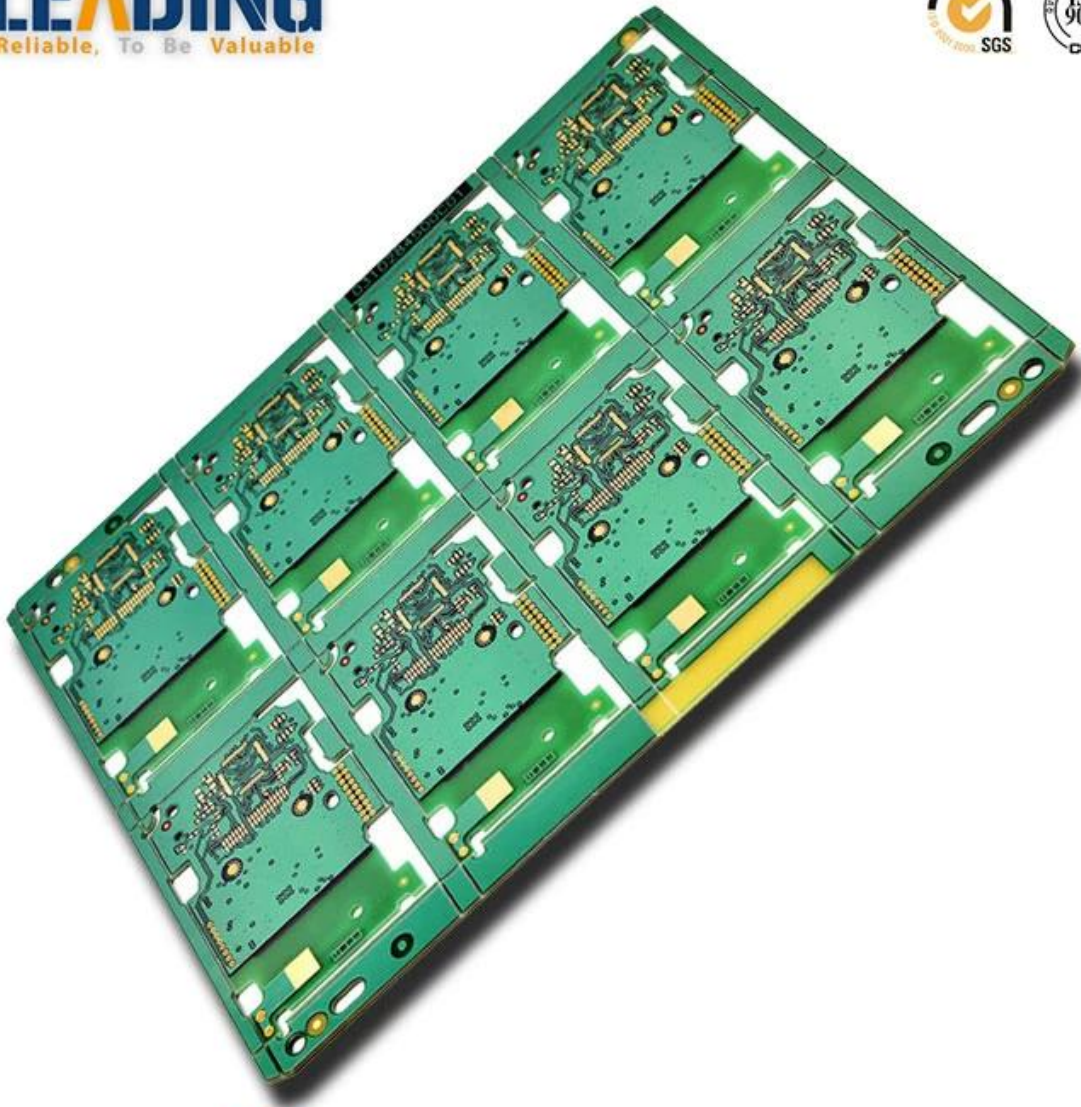

MAKE YOUR IDEA COME **TRUE**

TOP QUALITY PCBA

O-LEADING

To Be Reliable, To Be Valuable

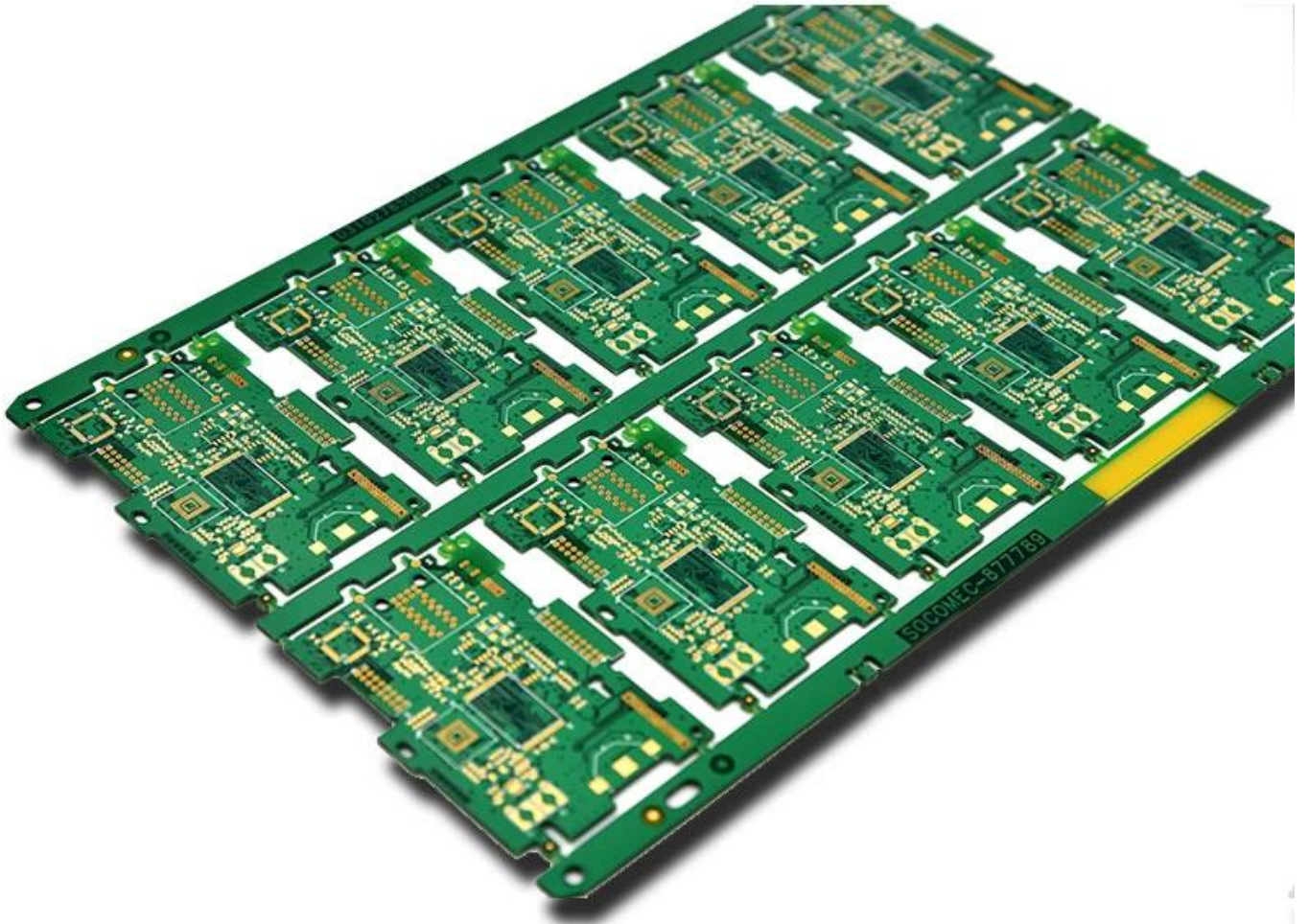

MAKE YOUR IDEA COME TRUE

TOP QUALITY PCBA

O-LEADING

To Be **Reliable**, To Be **Valuable**

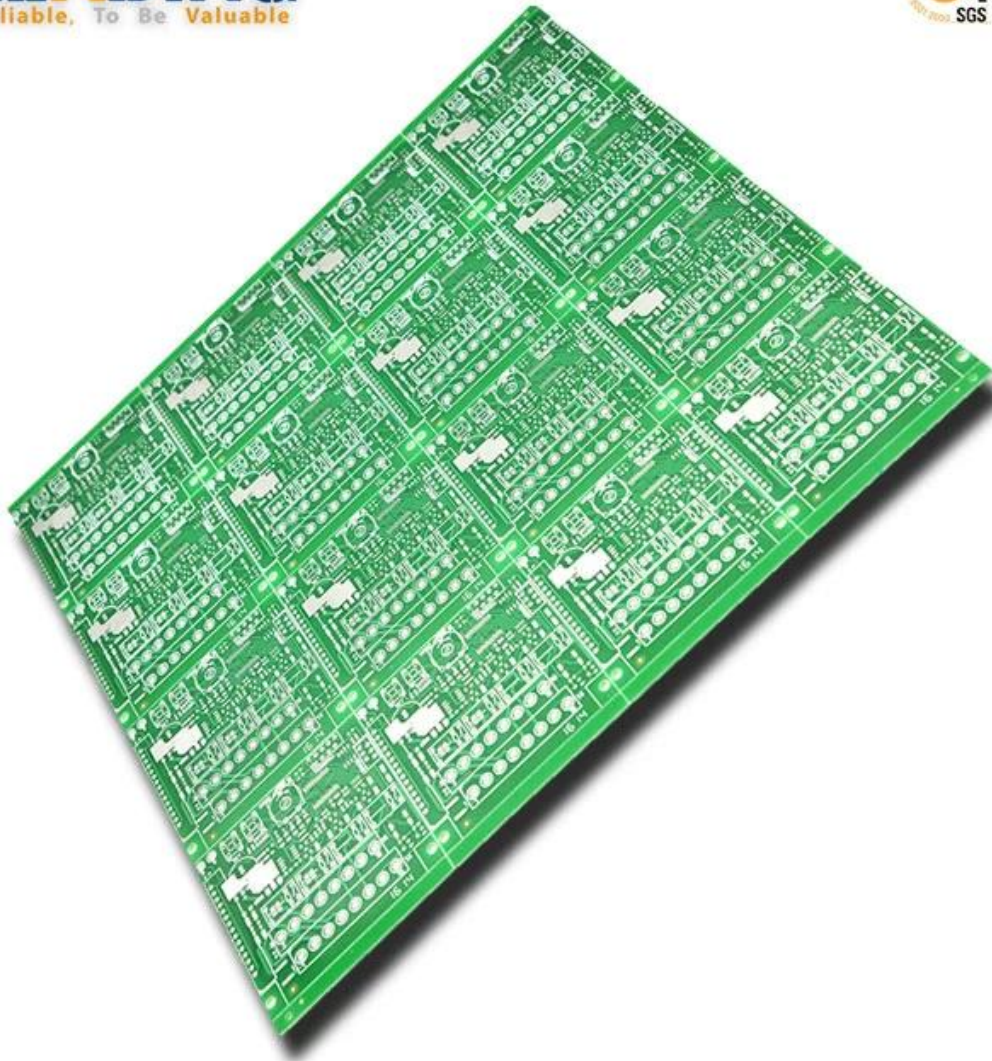

MAKE YOUR IDEA COME **TRUE**

TOP QUALITY PCBA

O-LEADING

To Be Reliable, To Be Valuable

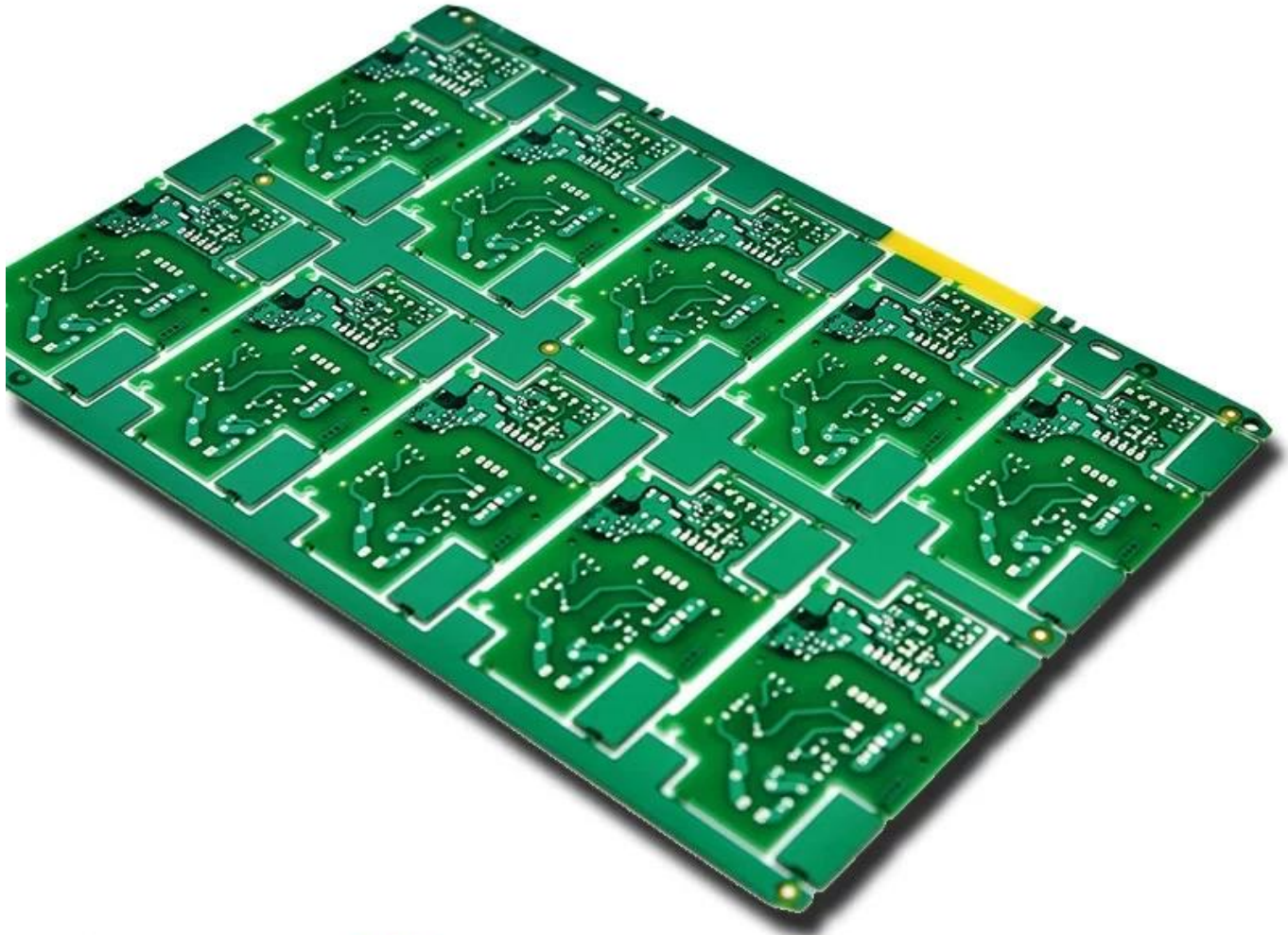

MAKE YOUR IDEA COME **TRUE**

Market Share

 CONSUMER ELECTRONICS

 AUTOMOTIVE ELECTRONICS

 INDUSTRIAL CONTROL

 INTELLECTUALIZED HOUSEHOLD CONTROL

 OTHER



30%
CONSUMER ELECTRONICS

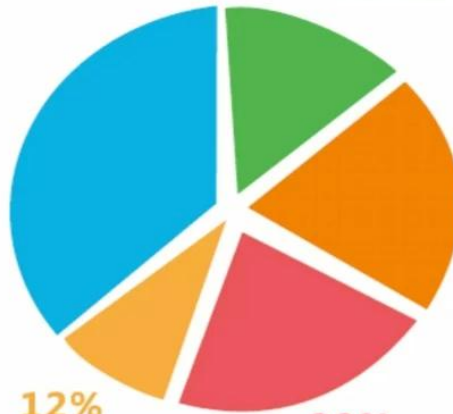

18%
INTELLECTUALIZED HOUSEHOLD CONTROL

20%
AUTOMOTIVE ELECTRONICS



12%
OTHER

20%
INDUSTRIAL CONTROL



Product types

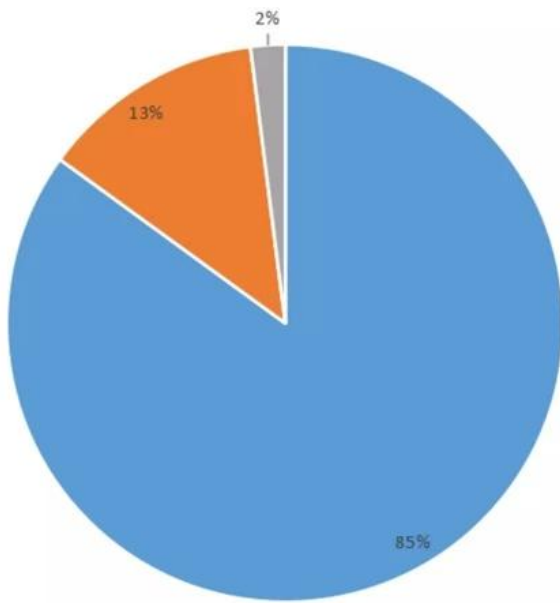

■ FR-4 PCB ■ MC PCB ■ rigid-flexible PCB

Product layers

■ 1L ■ 2L ■ 4L ■ 6L ■ >8L

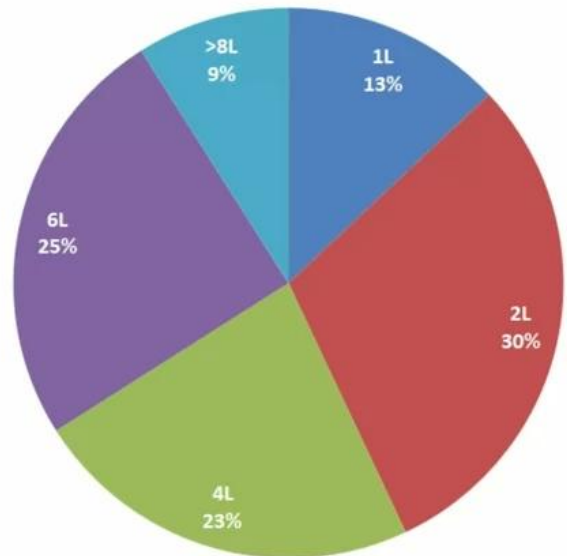

Production Process

18 years experience in one-stop PCB and PCBA, we can make your idea come true,



Nuestro equipo



Factory PCB



Automatic vacuum press machine



Drilling Machine



Pattern Plating Machine



Scrubbing Machine



Developing Machine



Routing Machine



High-speed flying probe machine



E-test Machine

Factory SMT



HOW O-LEADING MAKE A PROJECT FOR YOU

Hardware Dispenser Application Not



Automatic Dispenser Application Not

Voltage Table

Volt Pin Number	Description
VDD	Battery Voltage
+3V3	+3.3V
+5V	+5V
USB +5V	USB 5V input
+5V/2	Isolated +5V
+12V	12V DC Drive

STM32F072 PinOUT table

Wire Name	Description	DIO	Mode	Note
SM7N_TOF	Shutdown Time of flight sensor	Output	Logic '1' to shutdown	
I2C_SCL_TOF	I2C communication with time of flight sensor	I2C1_SCL		
I2C_SDA_TOF	I2C communication with thermopile sensor	I2C1_SDA		
I2C_SCL_IR	I2C communication with load cell control pins	I2C2_SCL		
I2C_SDA_IR		I2C2_SDA		
RATE_IC		Output		
DOUT_IC		Output		

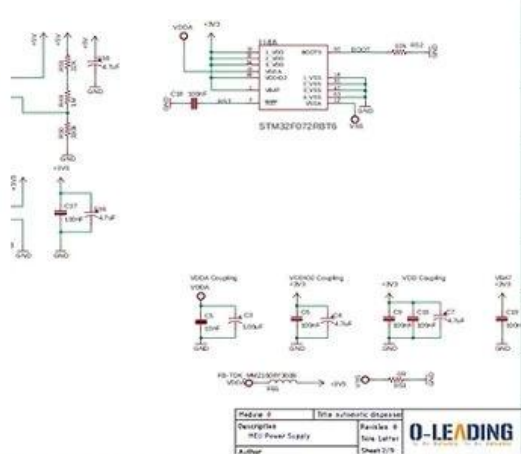

HARDWARE schematics

PCB PRODUCTION COMPONENTS SOURCING

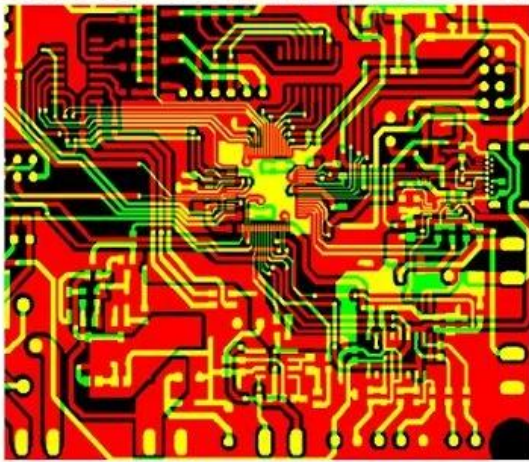

Qty	Value	Device	Parts	Description
4	AK500/1	AK500/2	X1, X2	CONNECTOR
1	AK500/1	AK500/3	X7	CONNECTOR
1	124114	MA04-2	SV2	
1	PPPC04	MA04-2	SV1	8 POS, 4*2 FEMALE PIN HEADS
1	ML10	ML10	SV4	HARTING
1	8MHZ	XTALL_CSTCE8M	X5	STCE8M00G52-R0 RESONATOR
1	0R	R-0603	R53	Thick Film Resistors - SMD 0603
2	10R	R-0603	R12, R5	Thick Film Resistors - SMD 0603
8	100R	R-0603	R1, R2	Thick Film Resistors - SMD 0603
1	270R	R-0805	R15	Thick Film Resistors - SMD 0605
1	330R	R-0603	R11	Thick Film Resistors - SMD 0603
9	680R	R-0603	R20, R3	Thick Film Resistors - SMD 0603
17	1k	R-0603	R9, R10	Thick Film Resistors - SMD 0603
2	4.7k	R-0603	R17, R6	Thick Film Resistors - SMD 0603
2	5.1k	R-0603	R18, R7	Thick Film Resistors - SMD 0603
9	10k	R-0603	R16, R3	Thick Film Resistors - SMD 0603

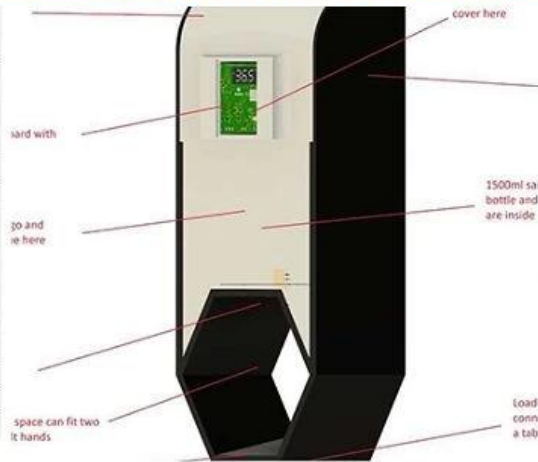
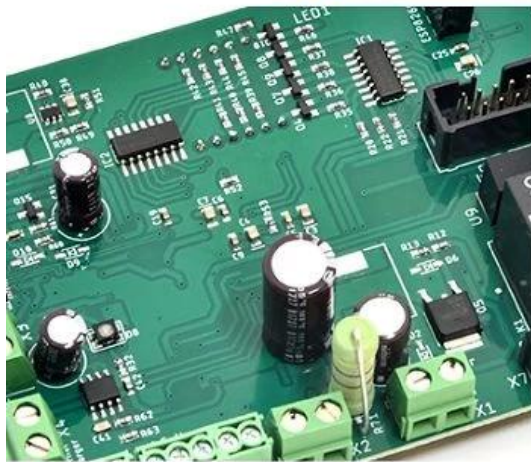

PCB Assembly MECHANICAL DESIGN

O-LEADING CUSTOMER

To be **RELIABLE**

- Q**uality first ,
- C**ustomer supreme ,
- S**cientifically management ,
- S**triving for famous brand



THE CUSTOMER IS KING

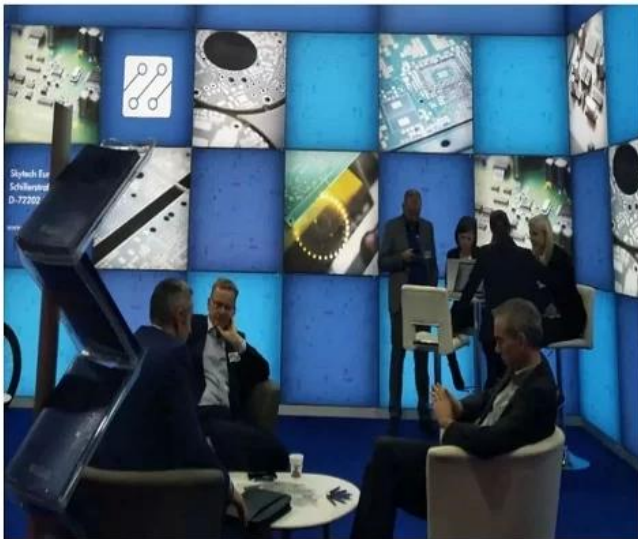

To be **VALUABLE**

- S**cience and technology keeps head ,
- P**ut people first ,
- B**e precise and practical ,
- C**ontribute sincerely

Skyworth 创维

HET 和而泰
HET INTELLIGENT CONTROL

dongweikeji
东威科技

美的 Midea

STAR-NET
星网锐捷

FORYOU
ADAYO 华阳集团

EDIFIER[®]

Cultraview 金锐显

3nod 三诺

T&W

TCL

AcBel 康舒科技
ACBEL POLYTECH INC.

Honeywell

Schneider
Electric

ZTE 中兴

EMERSON

BYD

PHILIPS

TE
connectivity

VIDEOTON

O-LEADING CUSTOMER REVIEW

CUSTOMER VOICE IS EXTREMELY IMPORTANT TO US

订单编号: 49335463501024670

供应商服务: 非常满意 (5 stars) 按时发货: 非常满意 (5 stars)

High quality usb power pcb , pcba manufacturer

★★★★★

Fancy has done an excellent job, whenever we write, she answered us within 1 second, O-leading is very perfect with fast delivery, fast logistics, the most important thing is good quality, good packaging, thank you!

[回复该评论](#)

oem customized rohs pcb drawing schematic s...

★★★★★

We received the boards, the quality is very good, the price is very reasonable, Fancy is very nice & smart & experienced, the logistics is super fast, I will come to see more in the future.

[回复该评论](#)

订单编号: 49298271001024670

供应商服务: 非常满意 (5 stars) 按时发货: 非常满意 (5 stars)

High TG180 FR-4 Circuit HDI PCB 94V0 Board ...

★★★★★

perfect product, perfect PCB supplier!

[回复该评论](#)

oem customized rohs pcb drawing schematic s...

★★★★★

Very good and professional PCB product as usual!

[回复该评论](#)

Strip LED Aluminum FR-4 lighting PCB board 9...

★★★★★

High quality, fast delivery, good service, competitive price, lucky and happy to purchase from O-leading!

[回复该评论](#)

订单编号: 49024962001024670

United States

供应商服务: 非常满意 (5 stars) 按时发货: 非常满意 (5 stars)

High quality Keyboard pcb & pcba Factory SMT...

★★★★★

Top quality, it's the right choice to choose O-leading to make the PCB & PCBA

[回复该评论](#)

订单编号: 4093862201024670

供应商服务: 非常满意 (5 stars) 按时发货: 非常满意 (5 stars)

Professional Printed Circuit Board Manufact...

★★★★★

Very high quality PCB products, O-leading is the best PCB supplier that we have ever worked with.

订单编号: 44068794501024670

供应商服务: 非常满意 (5 stars) 按时发货: 非常满意 (5 stars)

High TG180 FR-4 Circuit HDI PCB 94V0 Board ...

★★★★★

We bought two batches, one by DHL, the other one by air, good quality and fast delivery!

LISTEN TO CUSTOMER VOICE

订单编号: 40903347501024670

供应商服务: 非常满意 (5 stars) 按时发货: 非常满意 (5 stars)

Strip LED Aluminum FR-4 lighting PCB board 9...

★★★★★

Very fast delivery! Fantastic, good job!!!

Professional Printed Circuit Board Manufact...

★★★★★

Very happy to great support from O-leading, they are not only professional on the PCB, but also provide good PCB products, very good supplier!

hot sale rigid-flexible PCB with 0.2mm BGA an...

★★★★★

very professional supplier

High Quality custom FPCB/Flex PCB/FPC/Flexi...

★★★★★

Good product

OEM ODM PCBA Bluetooth Wireless Marking G...

★★★★★

high soldering quality

Electronic parts haptic pcba Circuit Board asse...

★★★★★

Very Good product

订单编号: 36919647001024670

供应商服务: 非常满意 (5 stars) 按时发货: 非常满意 (5 stars)

AML-S802 Quad-core Android embedded boar...

★★★★★

Good products

Fast delivery low cost pcb fabrication O-leadin...

★★★★★

Good supplier

Lidar IR Sensor board pcba(H08R6x)

★★★★★

perfect product

Customized PCBA design PCB design

★★★★★

perfect

Audio Speaker and Headphone Jack (H07R3x)

★★★★★

High quality, good

订单编号: 37378603001024670

供应商服务: 非常满意 (5 stars) 按时发货: 非常满意 (5 stars)

half hole pcb, half hole pcb module, half hole m...

★★★★★

Top half hole pcb supplier, very perfect goods

High Quality custom FPCB/Flex PCB/FPC/Flexi...

★★★★★

this rigid-flexible pcb quality is perfect!

Electronic parts haptic pcba Circuit Board asse...

★★★★★

Very satisfied with O-leading products and quality, especially their on-time delivery, fantastic!

Raspberry pi 0 Zero Raspberry Pi Zero Pi W ver...

★★★★★

Fantastic products!!

double layer pcb with red S/M and LF-HASL su...

★★★★★

Good!

Be kind to your client, because he has many choices, but he chooses you instead.

Certificaciones

CICC INSPECTION CERTIFICATION



嘉泰认证

QUALITY MANAGEMENT SYSTEM CERTIFICATE

Certificate No: 18118Q10347R05

We hereby certify that

O-LEADING SUPPLY CHAIN(HK) CO.,LIMITED
 Credit No: 61691591-000-07-18-7
 Registration Add: FLAT/RM 1205 12/F TAI SANG BANK BUILDING 130-132 DES
 VODEUS BOAD CENTRAL HK
 Business Add: 1313, Floor 13, Fortune Building, Danshui Town, Huiyang
 District, Huizhou, Guangdong, China

Has implemented and maintains a **Quality Management System**
 Which fulfils the requirements of the following standards
GB/T19001-2016 idt ISO9001:2015

Scope of certification
 Sales of printed circuit boards

Initial issuance period: February 27, 2018
 Renewal date: April 22, 2019

This certificate is valid during: April 22, 2019 ~ February 26, 2021
 This certificate is invalid without CICC qualified label in the following period

First supervision and audit	Second supervision and audit	Qualified mark
-----------------------------	------------------------------	----------------

The certification implementation scope does not include those production services which shall be obtained by the relevant effective administrative procedures and qualification procedures regulated by the state.
 The effectiveness of this certificate shall be notified by annual surveillance audits of CICC. The certificate shall be valid also only together with the surveillance audit certificate.
 The initial information of this certificate can be searched at the portal of CICC: www.cicc.com.cn
 In the case of changes see clause 8.1.2.





CICC INSPECTION CERTIFICATION



嘉泰认证

质量管理体系认证证书

证书号: 18118Q10347R05

兹证明

诚领供应链(香港)有限公司
 统一社会信用代码: 61691591-000-07-18-7
 注册地址: 香港中環德輔道中 130-132 號大生銀行大廈 1205 室
 经营地址: 广东惠州惠阳淡水南亨西路财富大厦 13 楼 1313



建立的质量管理体系符合
GB/T19001-2016 idt ISO9001:2015 质量标准适用条款的要求

认证范围
 印刷线路板的销售

初次发证日期: 2018年02月27日
 换证日期: 2019年04月22日
 证书有效期: 自2019年04月22日至2021年02月26日
 在下列期限内, 未经 CICC 黏贴合格标贴, 本证书无效

第一次监审	第二次监审	粘标处
-------	-------	-----

本证书认证范围不包括未获得有效的国家规定的行政许可、资质许可的产品/服务范围。
 本证书通过CICC定期监督审核保持, 与年度《保持认证通知书》共同方为有效。
 本证书信息可在国家认监委网站: www.cnca.gov.cn及CICC网站www.cicc.com.cn查询。





Test Report

No. SZXEC1900530401 Date: 30 Mar 2019 Page 1 of 6

O-LEADING SUPPLY CHAIN (HK) CO., LIMITED

1313.FLOOR 13, FORTUNE BUILDING, DANSHUI TOWN, HUIYANG DISTRICT, HUIZHOU, GUANGDONG, CHINA

The following sample(s) was/were submitted and identified on behalf of the clients as : OSP

SGS Job No.: RP19-005089 - SZ
Date of Sample Received: 22 Mar 2019
Testing Period: 22 Mar 2019 - 30 Mar 2019
Test Requested: Selected test(s) as requested by client.
Test Method: Please refer to next page(s).
Test Results: Please refer to next page(s).

Conclusion: Based on the performed tests on submitted sample(s), the results of Lead, Mercury, Cadmium, Hexavalent chromium, Polybrominated biphenyls (PBBs), Polybrominated diphenyl ethers (PBDEs) and Phthalates such as Bis(2-ethylhexyl) phthalate (DEHP), Butyl benzyl phthalate (BBP), Dibutyl phthalate (DBP), and Diisobutyl phthalate (DIBP) comply with the limits as set by RoHS Directive (EU) 2015/863 amending Annex II to Directive 2011/65/EU.

Signed for and on behalf of
SGS-CSTC Standards Technical Services Co., Ltd. Shenzhen Branch

Tina
Tina Fan
Approved Signatory



Member of the SGS Group (SGS SA)



Test Report

No. SZXEC1900530401 Date: 30 Mar 2019 Page 2 of 6

Test Results:

Test Part Description:

Table with 3 columns: Specimen No., SGS Sample ID, Description. Row 1: SN1, SZX19-005304.001, Green"PCB"

Remarks:

- (1) 1 mg/kg = 1 ppm = 0.0001%
(2) MDL = Method Detection Limit
(3) ND = Not Detected (< MDL)
(4) "-" = Not Regulated

RoHS Directive (EU) 2015/863 amending Annex II to Directive 2011/65/EU

Test Method: With reference to IEC 62321-4:2013+A1:2017, IEC 62321-5:2013, IEC 62321-7-2:2017, IEC 62321-6:2015 and IEC 62321-8:2017, analyzed by ICP-OES, UV-Vis and GC-MS.

Table with 5 columns: Test Item(s), Limit, Unit, MDL, 0/1. Lists various heavy metals and phthalates with their respective limits and detection results.



Member of the SGS Group (SGS SA)



ZPMV2.E490354 - WIRING, PRINTED - COMPONENT

Wiring, Printed - Component

See General Information for Wiring, Printed - Component

O-LEADING SUPPLY CHAIN (HK) CO LTD
 ROOM 1205, 12/F
 TAI SANG BANK BLDG
 130-132 DES VOEUS ROAD
 CENTRAL, HONG KONG

E490354

Type	Cond Width		Cond Thk	SS/ DS/ DSO	Max	Max		Meets	C			
	Min	Edge			Area	Solder Limits	Oper Temp			Flame		
	mm(in)	mm(in)	mic(mil)		mm(in)	C	sec	C	Class	UL796	DSR	I
Multilayer (mass laminate) printed wiring boards.												
O-LEADING-401	0.1 (0.004)	0.3 (0.012)	34 (1.34)	DS	12.7 (0.5)	260	10	130	V-0	-	-	
O-LEADING-407	0.08 (0.003)	0.2 (0.008)	17 (0.67)	DS	9.7 (0.4)	260	10	130	V-0	All	-	
Multilayer printed wiring boards.												
O-LEADING-408	0.125 (0.005)	0.125 (0.005)	12 (0.47) Int:136	DS	50.8 (2.0)	280	20	130	V-0	All	*	
Single layer printed wiring boards.												
O-LEADING-002	0.38 (0.015)	1.14 (0.045)	34 (1.34)	SS	19.1 (0.8)	260	10	105	V-0	All	-	
O-LEADING-003	0.38 (0.015)	1.14 (0.045)	34 (1.34)	SS	19.1 (0.8)	260	10	130	V-0	▲	-	
O-LEADING-033	0.15 (0.006)	0.3 (0.012)	34 (1.34)	SS	25.4 (1.0)	260	10	120	V-0	All	-	
O-LEADING-205	0.1 (0.004)	0.3 (0.012)	34 (1.34)	DS	69.6 (2.7)	260	10	130	V-0	All	-	
O-LEADING-206	0.15 (0.006)	0.33 (0.013)	17 (0.67)	DS	69.6 (2.7)	260	10	130	V-0	All	-	
O-LEADING-D01	0.14 (0.006)	0.15 (0.006)	33 (1.30)	DS	25.4 (1.0)	260	10	130	V-0	All	*	
O-LEADING-S01	0.25 (0.010)	0.25 (0.010)	17 (0.67)	SS	25.4 (1.0)	260	4	130	V-0	All	*	

WIRING, PRINTED - COMPONENT | UL Product iQ

O-LEADING-S02	0.2 (0.008)	0.2 (0.008)	17 (0.67)	SS	25.4 (1.0)	260	4	130	HB	▲	*	
O-LEADING-S03	0.25 (0.010)	0.25 (0.010)	34 (1.34)	SS	25.4 (1.0)	260	4	130	V-0	All	*	

* - CTI marking is optional and may be marked on the printed wiring board.

Marking: Company name or file number and type designation. May be followed by a suffix to denote factory identification or burning test classification.

并不是所有出现在本数据库中的公司名称和产品都满足了UL跟踪检验服务的要求。只有带有UL标志的产品，才应该被视为经过UL认证，并满足UL跟踪检验服务的要求。注意查看产品上的标志。

UL 允许在线认证目录中所含材料的复制遵循以下条件：1.指南信息、装配、构造、设计、系统和/或认证（文件）必须在不篡改任何数据（或图纸）的情况下完整且无误导性地呈现。2.经UL允许从在线认证目录转载“声明必须出现在所提取材料的邻近位置。此外，转载材料必须包含以下格式的版权声明：“© 2019 UL LLC”

Capacidad de procesamiento

Capacidades de producción de PCB

Recuento de capas	1Layer-32Layer
Espesor de cobre terminado	1 / 3oz-12oz
Mínimo ancho de línea / espaciado interno	3,0 mil / 3,0 mil
Ancho de línea mínimo / espaciado externo	4.0 mil / 4.0 mil
Relación de aspecto máxima	10: 1
Espesor del tablero	0,2 mm a 5,0 mm
Tamaño máximo del panel (pulgadas)	635 * 1500 mm
Tamaño mínimo del orificio perforado	4 mil
Tolerancia de orificio revestido	+/- 3 mil
Vias Blind / Enterradas (Tipos AII)	SI
Vía relleno (conductivo, no conductivo)	SI
Material de base	FR-4, FR-4 de alta Tg. Material libre de halógenos, Rogers, Base de aluminio, Poliamida, cobre pesado
Acabados superficiales	HASL, OSP, ENIG, HAL-LF, plata de inmersión, Estaño de inmersión, dedos de oro, tinta de carbón

Capacidades de producción SMT

Material de PCB	FR-4, CEM-1, CEM-3, tablero a base de aluminio, FPC
Tamaño máximo de PCB	510x1500mm
Tamaño mínimo de PCB	50x50mm
Espesor de PCB	0,5 mm a 4,5 mm
Espesor del tablero	0,5-4 mm
Tamaño mínimo de los componentes	0201
Componente de tamaño de chip estándar	0603 y mayor
Altura máxima del componente	15 mm
Paso mínimo de plomo	0,3 mm
Paso mínimo de bola BGA	0,4 mm
Precisión de colocación	+/- 0,03 mm

Empaquetado y entrega

Shipping service



Quick Turn Lead Time		
Layer Count:	Lead Tim	Special Requirement
1L/2L	2-3days	24 Hours,48 Hours
4L	3-4days	48 Hours
6L	4-5days	72 Hours
8L	5-6days	NA
10L	6-7days	NA
12L	7-8days	NA
14L	8-9days	NA

Standard Lead Time		
Layer Count:	Sample Lead Time	Volume order lead time
2L	4 days	10 days
4L	5 days	11 days
6L	6 days	12 days
8L	8 days	14 days
10L	10 days	16 days
12L	12 days	18 days
14L	14 days	20 days
16-32L	18 days	24 days

Preguntas más frecuentes

1. ¿Cómo asegura O-Leading la calidad? Nuestro alto estándar de calidad se logra con lo siguiente.

- 1.1 El proceso está estrictamente controlado bajo las normas ISO 9001: 2008.
- 1.2 Uso extensivo de software en la gestión del proceso de producción
- 1.3 Equipos y herramientas de prueba de última generación. P.ej. Flying Probe, inspección de rayos X, AOI (inspector óptico automatizado) e ICT (pruebas en circuito).
- 1.4 Equipo de aseguramiento de la calidad dedicado con proceso de análisis de casos de falla
- 1.5 Formación y educación continua del personal

2. ¿Cómo mantiene O-Leading su precio competitivo?

Durante la última década, los precios de muchas materias primas (por ejemplo, cobre, productos químicos) se duplicaron, triplicaron o cuadruplicaron; La moneda china RMB se había apreciado un 31% con respecto al dólar estadounidense; Y nuestro costo laboral también aumentó significativamente.

Sin embargo, O-Leading ha mantenido nuestros precios estables. Esto se debe enteramente a nuestras innovaciones para reducir costos, evitar desperdicios y mejorar la eficiencia. Nuestros precios son muy competitivos en la industria al mismo nivel de calidad.

Creemos en una asociación de beneficio mutuo con nuestros clientes. Nuestra asociación será de beneficio

mutuo si podemos ofrecerle un coste y una calidad superiores.

3. ¿Qué tipo de tableros puede procesar O-Leading?

Placas comunes FR4, High-TG y libres de halógenos, Rogers, Arlon, Telfon, placas a base de aluminio / cobre, PI, etc.

4. ¿Qué datos se necesitan para la producción de PCB y PCBA?

4.1 Lista de materiales (BOM) con designadores de referencia: descripción del componente, nombre del fabricante y número de pieza.

4.2 Archivos Gerber de PCB.

4.3 Plano de fabricación de PCB y plano de montaje de PCBA.

4.4 Procedimientos de prueba.

4.5 Cualquier restricción mecánica, como los requisitos de altura de montaje.

5. ¿Cuál es el flujo de proceso típico para PCB multicapa?

Corte de material → Película seca interna → Grabado interno → AOI interno → Multi-bond → Apilado de capas Presionando → Perforación → PTH → Revestimiento de panel → Película seca externa → Revestimiento de patrón → Grabado externo → AOI externo → Máscara de soldadura → Marca de componente → Acabado de superficie → Enrutamiento → E / T → Inspección visual.

6. ¿Cuáles son los equipos clave para la fabricación de HDI?

La lista de equipos clave es la siguiente: perforadora láser, máquina de prensado, línea VCP, máquina de exposición automática, LDI, etc. Los equipos que tenemos son los mejores de la industria, las perforadoras láser son de Mitsubishi e Hitachi, las máquinas LDI son de Screen (Japón), las máquinas de exposición automática también son de Hitachi, todas ellas hacen que podamos cumplir con los requisitos técnicos del cliente.

7. ¿Cuántos tipos de acabado superficial O-lead puede hacer?

O-the leader tiene la serie completa de acabados superficiales, tales como: ENIG, OSP, LF-HASL, chapado en oro (suave / duro), plata de inmersión, estaño, chapado en plata, estañado por inmersión, tinta de carbón y etc. OSP, ENIG, OSP + ENIG de uso común en el HDI, generalmente recomendamos que utilice un cliente o OSP OSP + ENIG si el tamaño de BGA PAD es inferior a 0,3 mm.

8. ¿Cuál es su capacidad para FPC? ¿O-Leading también puede proporcionar servicio SMT?

O-Leading puede fabricar FPC de una sola capa a 8 capas, el tamaño del panel de trabajo puede ser tan grande como 2000 mm * 240 mm, encuentre los detalles en la página "Capacidad de Flexión". También proporcionamos un servicio integral de SMT al cliente.

9. ¿Cuáles son los principales factores que afectarán el precio de los PCB?

Material;

Acabado de superficie;

Dificultad tecnológica;

Diferentes criterios de calidad;

Características de PCB;

Términos de pago;

Diferentes países de fabricación.

10. ¿Cuál es la definición de PCB, PWB y FPC y cuál es la diferencia?

PCB es la abreviatura de placa de circuito impreso;

PWB es la abreviatura de Printed Wire Board, con el mismo significado que Printed Circuit Board;

FPC es la abreviatura de Tablero impreso flexible.

11. ¿Qué factores deben tenerse en cuenta al elegir el material para una placa PCB?

Los siguientes factores deben considerarse cuando elegimos el material para PCB:

El valor de Tg del material debe ser mayor que la temperatura de operación;

El material de bajo CTE tiene un buen rendimiento de estabilidad térmica;

Buen rendimiento de resistencia térmica: normalmente se requiere que los PCB resistan 250 °C durante al menos 50 segundos.

Buena planitud; Teniendo en cuenta las propiedades eléctricas, se utiliza material de baja pérdida / alta permitividad en PCB de alta frecuencia;

Sustrato de fibra de vidrio de poliimida utilizado para PCB flexible; El núcleo de metal se utiliza cuando el producto tiene un requisito estricto de calor. disipación.

12. ¿Cuáles son las ventajas de la placa de circuito impreso rígido-flexible de O-leading?

El PCB rígido-flexible de O-Leader tiene los caracteres de FPC y PCB, por lo que puede usarse en algunos productos especiales. Una parte es flexible mientras que la otra parte rígida, puede ayudar a ahorrar espacio interior del producto, reducir el volumen del producto y mejorar el rendimiento.

13. ¿Cómo se hace el cálculo de la impedancia?

El sistema de control de impedancia se realiza utilizando algunos cupones de prueba, el equipo SI6000 soft y el CITS 500s de POLAR INSTRUMENTS. El equipo mide la impedancia en un cupón de configuración de pista representativa del cual el cliente nos ha dado un valor y tolerancia determinados.