

Willkommen bei O-Leading

O-Leading ist bestrebt, Ihr One-Stop-Lösungspartner in der EMS-Lieferkette zu sein, einschließlich Leiterplattendesign, Leiterplattenherstellung und Leiterplattenbestückung (PCBA). Wir bieten einige der fortschrittlichsten Leiterplattentechnologien, einschließlich HDI-Leiterplatten, Mehrschicht-Leiterplatten und starrflexiblen Leiterplatten. Wir können vom schnellen Prototyp bis zur mittleren und Massenproduktion unterstützen. ([C.Aufbau und Herstellung von Steuerplatinen und PCBA-Montage](#))

Im Allgemeinen sind unsere globalen Kunden von unseren Dienstleistungen sehr beeindruckt: Schnelle Reaktion, wettbewerbsfähiger Preis und Qualitätsverpflichtung. Die Bereitstellung eines wertvolleren technischen Service und einer Gesamtlösung ist der Weg nach vorne.

Mit Blick auf die Zukunft wird sich O-Leading wie immer auf die Innovation und Entwicklung der Elektronikfertigungstechnologie konzentrieren und sich konsequent um PCB & PCBA One-Stop-Service bemühen, um erstklassige Services bereitzustellen und mehr Wert für unsere Kunden zu schaffen.

BITTE KLICKEN SIE AUF DIESE FÜR WEITERE INFORMATIONEN: [E.Lectronic Oem 4-lagiger Leiterplatten-Baugruppensensor Pcba Factory](#)

Produktbeschreibung

HOW O-LEADING MAKE A PROJECT FOR YOU

Hardware Dispenser Application Not

Automatic Dispenser Application Not

Voltage Table

Volt Pin Number	Description
VDD	Battery voltage
+3V3	+3.3V
+5V	+5V
USB +5V	USB 5V input
+5V/2	Isolated +5V
+12V	12V DC Drive

STM32F072 PINOUT table

Wire Name	Description	DIO	Mode	Note
SMTN_TOF	Shutdown Time of flight sensor	Output		Logic '0' to shutdown
I2C_SCL_TOF	I2C communication with time of flight sensor	I2C1_SCL		
I2C_SDA_TOF	I2C communication with thermopile sensor	I2C1_SDA		
I2C_SCL_IR	I2C communication with thermopile sensor	I2C2_SCL		
I2C_SDA_IR	I2C communication with thermopile sensor	I2C2_SDA		
RATE_LC	Load cell control pins	Output		
DOUT_LC	Load cell control pins	Output		

O-LEADING
TO BE RELIABLE, TO BE AVAILABLE

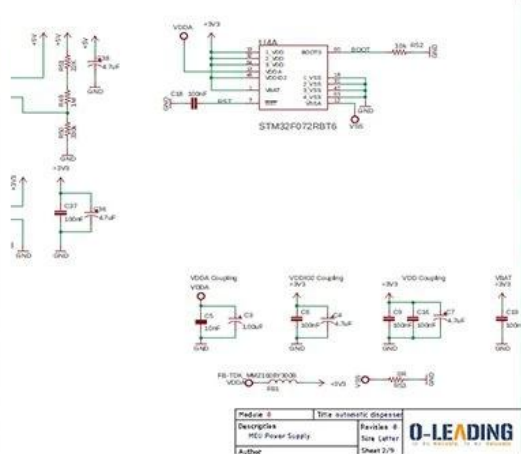

HARDWARE schematics

PCB PRODUCTION COMPONENTS SOURCING

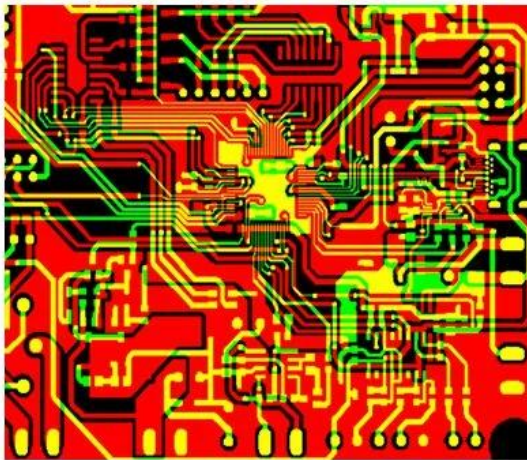

Qty	Value	Device	Parts	Description
4	AK500/2	AK500/2	X1, X2	CONNECTOR
1	AK500/3	AK500/3	X7	CONNECTOR
1	1241148	MA04-2	SV2	
1	PPPC04	MA04-2	SV1	8 POS, 4*2 FEMALE PIN HEAD
1	ML10	ML10	SV4	HARTING
1	8MHZ	XTALL_CSTCE8M	X5	STCE8M00G52-R0 RESONATOR
1	0R	R-0603	R53	Thick Film Resistors - SMD 0603
2	10R	R-0603	R12, R5	Thick Film Resistors - SMD 0603
8	100R	R-0603	R1, R2	Thick Film Resistors - SMD 0603
1	270R	R-0805	R15	Thick Film Resistors - SMD 0605
1	330R	R-0603	R11	Thick Film Resistors - SMD 0603
9	680R	R-0603	R20, R3	Thick Film Resistors - SMD 0603
17	1k	R-0603	R9, R10	Thick Film Resistors - SMD 0603
2	4.7k	R-0603	R17, R6	Thick Film Resistors - SMD 0603
2	5.1k	R-0603	R18, R1	Thick Film Resistors - SMD 0603
9	10k	R-0603	R16, R3	Thick Film Resistors - SMD 0603

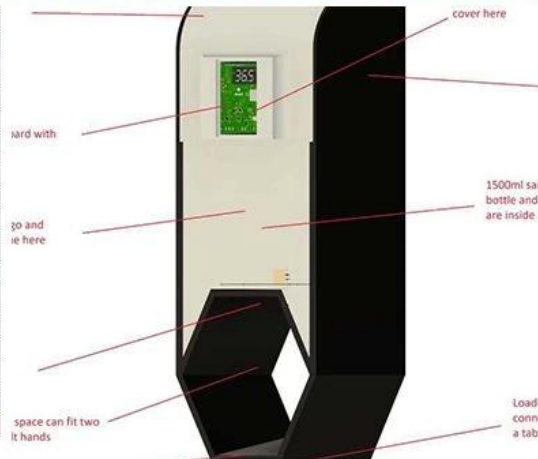
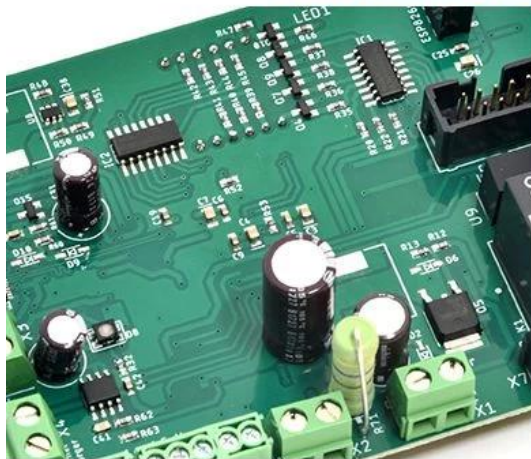

PCB Assembly MECHANICAL DESIGN

TOP QUALITY PCBA

O-LEADING

To Be Reliable, To Be Valuable



MAKE YOUR IDEA COME **TRUE**

TOP QUALITY PCBA

O-LEADING

To Be **Reliable**, To Be **Valuable**

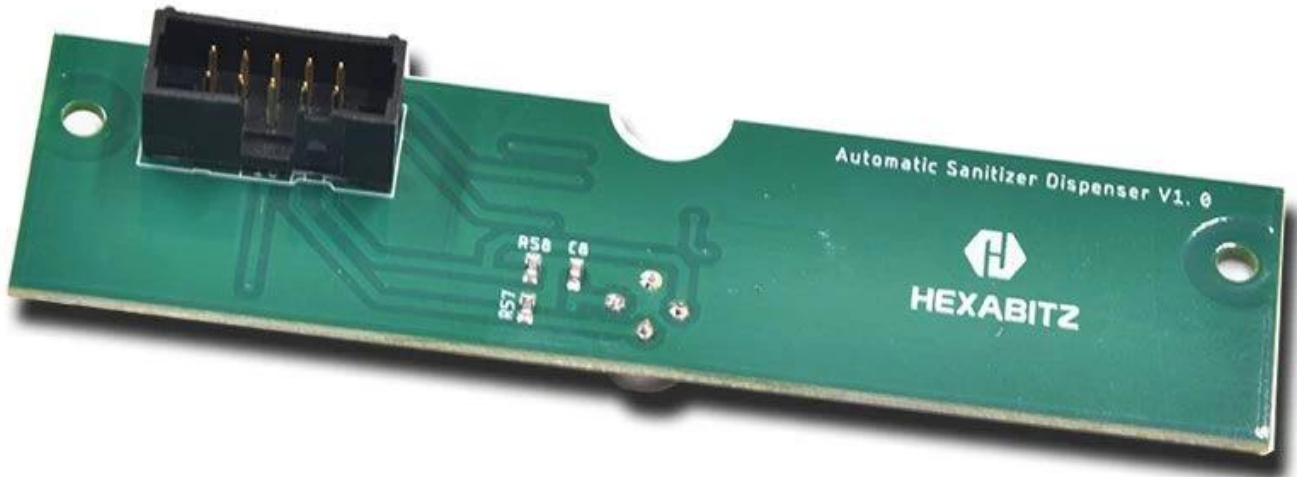

MAKE YOUR IDEA COME **TRUE**

TOP QUALITY PCBA

O-LEADING

To Be Reliable, To Be Valuable

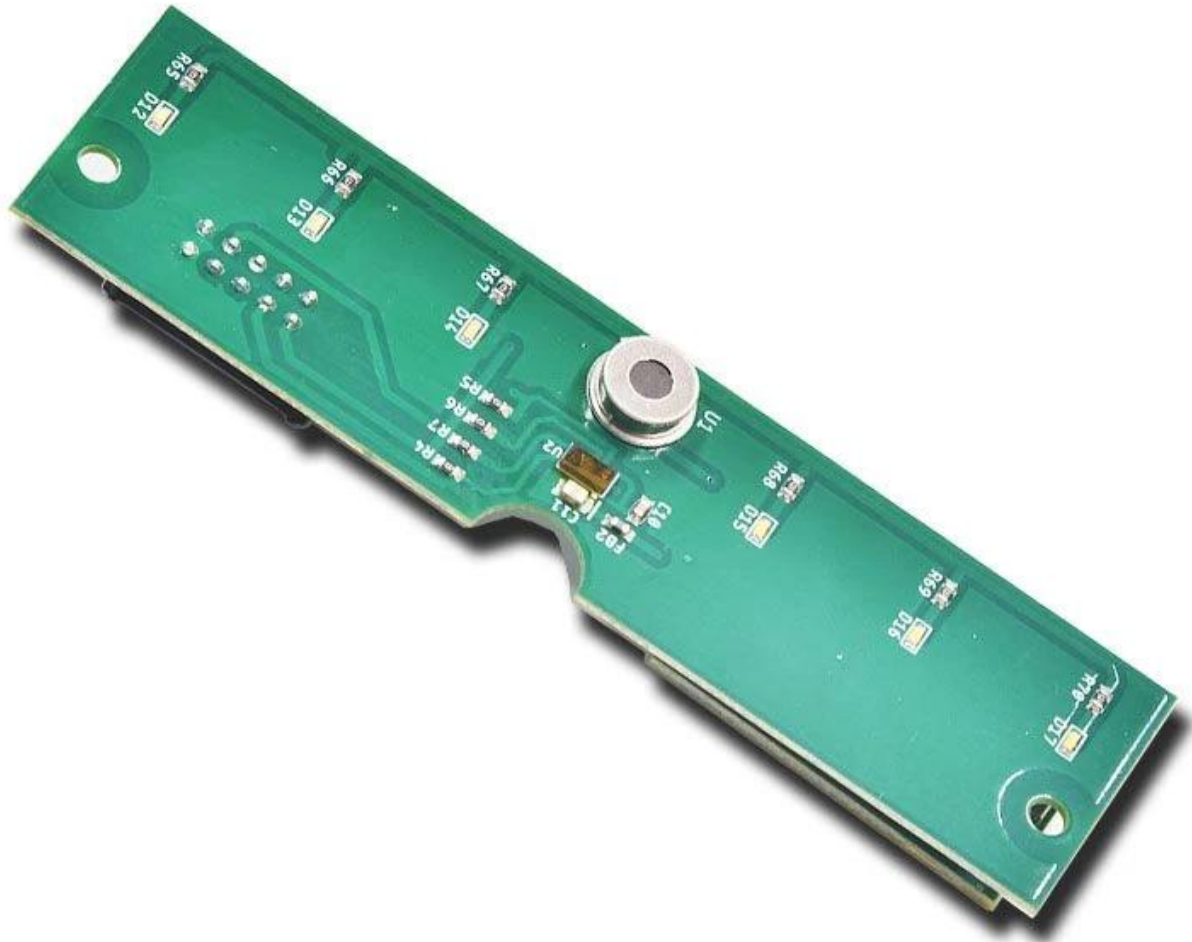

MAKE YOUR IDEA COME TRUE

Process Flow Chart

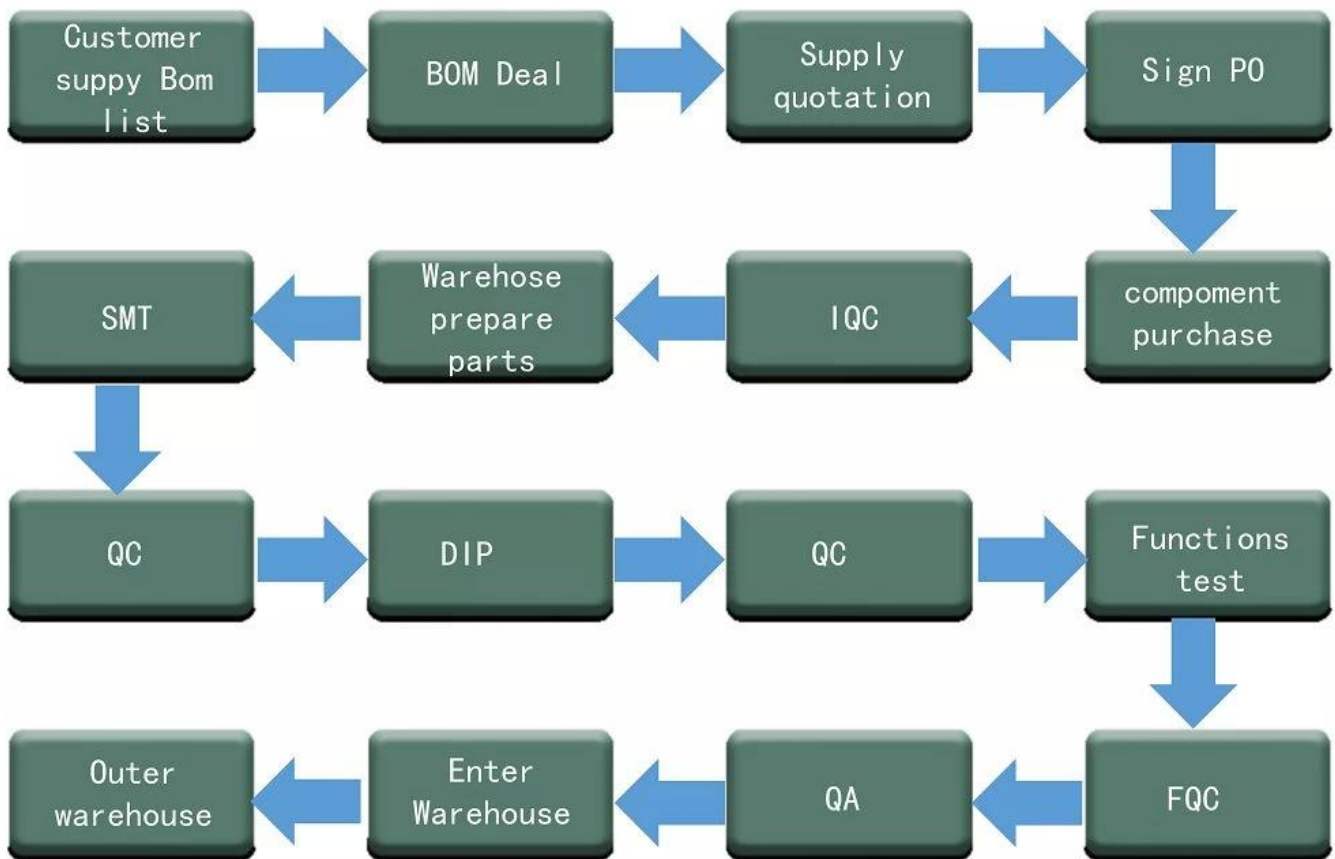

Quality Control Process

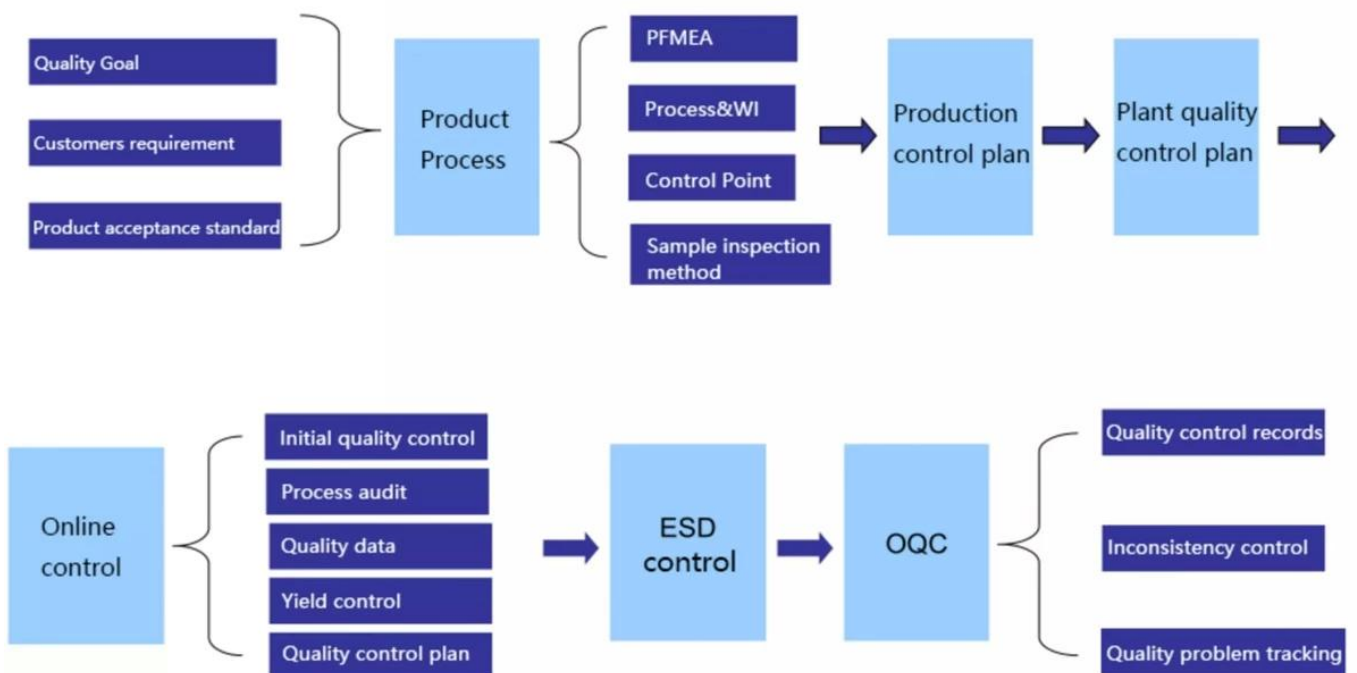



Unser Team

O-LEADING *CUSTOMER*

To be *RELIABLE*

- Quality first ,
- Customer supreme ,
- Scientifically management ,
- Striving for famous brand



THE CUSTOMER IS KING



To be *VALUABLE*

- Science and technology keeps head ,
- Put people first ,
- Be precise and practical ,
- contribute sincerely

Factory PCB



Automatic vacuum press machine



Drilling Machine



Pattern Plating Machine



Scrubbing Machine



Developing Machine



Routing Machine



High-speed flying probe machine



E-test Machine

Factory SMT



Skyworth 创维

HET 和而泰
HET INTELLIGENT CONTROL

dongweikeji
东威科技

美的 Midea

STAR-NET
星网锐捷

FORYOU
ADAYO 华阳集团

EDIFIER[®]

Cultraview 金锐显

3nod 三诺

T&W

TCL

AcBel 康舒科技
ACBEL POLYTECH INC.

Honeywell

Schneider
Electric

ZTE 中兴

EMERSON

BYD

PHILIPS

TE
connectivity

VIDEOTON

CUSTOMER VOICE IS **EXTREMELY IMPORTANT** TO US

<p>订单编号: 49335463501024670</p> <p>供应商服务: 非常满意 (5 stars) 按时发货: 非常满意 (5 stars)</p> <p>High quality usb power pcb , pcba manufacturer ★★★★★ Fancy has done an excellent job, whenever we write, she answered us within 1 second, O-leading is very perfect with fast delivery, fast logistics, the most important thing is good quality, good packaging, thank you!</p> <p>回复该评论</p> <p>oem customized rohs pcb drawing schematic s... ★★★★★ We received the boards, the quality is very good, the price is very reasonable, Fancy is very nice & smart & experienced, the logistics is super fast, I will come to see more in the future.</p> <p>回复该评论</p>	<p>订单编号: 49922411001024670</p> <p>供应商服务: 非常满意 (5 stars) 按时发货: 非常满意 (5 stars)</p> <p>High TG180 FR-4 Circuit HDI PCB 94V0 Board... ★★★★★ This is a very difficult PCB design, but we are lucky to find O-leading to support the PCB for us very good to a PCB supplier.</p> <p>Universal FR4 Multilayer PCB washing machine... ★★★★★ Fancy gives us very excellent service, very professional and experienced, O-leading is the best one of our suppliers, very happy to work with them.</p>
<p>订单编号: 49298271001024670</p> <p>供应商服务: 非常满意 (5 stars) 按时发货: 非常满意 (5 stars)</p> <p>High TG180 FR-4 Circuit HDI PCB 94V0 Board... ★★★★★ perfect product, perfect PCB supplier!</p> <p>回复该评论</p> <p>oem customized rohs pcb drawing schematic s... ★★★★★ Very good and professional PCB product as usual!</p> <p>回复该评论</p> <p>Strip LED Aluminum FR-4 lighting PCB board 9... ★★★★★ High quality, fast delivery, good service, competitive price, lucky and happy to purchase from O-leading!</p> <p>回复该评论</p>	<p>订单编号: 49024962001024670</p> <p>United States 供应商服务: 非常满意 (5 stars) 按时发货: 非常满意 (5 stars)</p> <p>High quality Keyboard pcb & pcba Factory SMT... ★★★★★ Top quality, it's the right choice to choose O-leading to make the PCB & PCBA</p> <p>回复该评论</p>
	<p>订单编号: 499862201024670</p> <p>供应商服务: 非常满意 (5 stars) 按时发货: 非常满意 (5 stars)</p> <p>Professional Printed Circuit Board Manufactur... ★★★★★ Very high quality PCB products, O-leading is the best PCB supplier that we have ever worked with.</p>
	<p>订单编号: 44068794501034670</p> <p>供应商服务: 非常满意 (5 stars) 按时发货: 非常满意 (5 stars)</p> <p>High TG180 FR-4 Circuit HDI PCB 94V0 Board... ★★★★★ We bought two batches, one by DHL, the other one by air, good quality and fast delivery!</p>

LISTEN TO **CUSTOMER VOICE**

<p>订单编号: 40903347501024670</p> <p>供应商服务: 非常满意 (5 stars) 按时发货: 非常满意 (5 stars)</p> <p>Strip LED Aluminum FR-4 lighting PCB board 9... ★★★★★ Very fast delivery! Fantastic, good job!!!</p> <p>Professional Printed Circuit Board Manufactur... ★★★★★ Very happy to great support from O-leading, they are not only professional on the PCB, but also provide good PCB products, very good supplier!</p>	<p>订单编号: 36919647001024670</p> <p>供应商服务: 非常满意 (5 stars) 按时发货: 非常满意 (5 stars)</p> <p>AML-S802 Quad-core Android embedded boar... ★★★★★ Good products</p> <p>Fast delivery low cost pcb fabrication O-leadi... ★★★★★ Good supplier</p>
<p>hot sale rigid-flexible PCB with 0.2mm BGA an... ★★★★★ very professional supplier</p> <p>High Quality custom FPCB/Flex PCB/FPC/Flexi... ★★★★★ Good product</p> <p>OEM ODM PCBA Bluetooth Wireless Marking G... ★★★★★ high soldering quality</p> <p>Electronic parts haptic pcba Circuit Board asse... ★★★★★ Very Good product</p>	<p>Lidar IR Sensor board pcba(H08R6x) ★★★★★ perfect product</p> <p>Customized PCBA design PCB design ★★★★★ perfect</p> <p>Audio Speaker and Headphone Jack (H07R3x) ★★★★★ High quality, good</p>
<p>订单编号: 37378603001024670</p> <p>供应商服务: 非常满意 (5 stars) 按时发货: 非常满意 (5 stars)</p> <p>Raspberry pi 0 Zero Raspberry Pi Zero PI W ver... ★★★★★ Fantastic products!!!</p> <p>double layer pcb with red S/M and LF-HASL su... ★★★★★ Good!</p>	<p>half hole pcb, half hole pcb module, half hole m... ★★★★★ Top half hole pcb supplier, very perfect goods</p> <p>High Quality custom FPCB/Flex PCB/FPC/Flexi... ★★★★★ this rigid-flexible pcb quality is perfect!</p> <p>Electronic parts haptic pcba Circuit Board asse... ★★★★★ Very satisfied with O-leading products and quality, especially their on-time delivery, fantastic!</p>

Be kind to your client, because he has many choices, but he chooses you instead.

Zertifizierungen

O-LEADING *TRAINING*



Keep *LEARNING*

There's a phrase in Buddhism, 'Beginner's mind.'

It's wonderful to have a beginner's mind

WE HAVE A *DREAM*

Keep *RUNNING*

I would like to live to study, and not study to live.

----Bacon

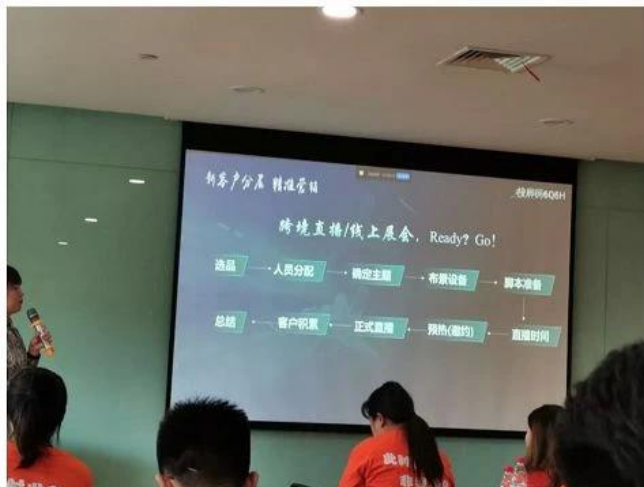



Test Report No. SZXEC1900530401 Date: 30 Mar 2019 Page 1 of 6

O-LEADING SUPPLY CHAIN (HK) CO., LIMITED
1313.FLOOR 13, FORTUNE BUILDING, DANSHUI TOWN, HUIYANG DISTRICT, HUIZHOU, GUANGDONG, CHINA

The following sample(s) was/were submitted and identified on behalf of the clients as : OSP

SGS Job No. : RP19-005089 - SZ
Date of Sample Received : 22 Mar 2019
Testing Period : 22 Mar 2019 - 30 Mar 2019
Test Requested : Selected tests(s) as requested by client.
Test Method : Please refer to next page(s).
Test Results : Please refer to next page(s).

Conclusion : Based on the performed tests on submitted sample(s), the results of Lead, Mercury, Cadmium, Hexavalent chromium, Polybrominated biphenyls (PBBs), Polybrominated diphenyl ethers (PBDEs) and Phthalates such as Bis(2-ethylhexyl) phthalate (DEHP), Butyl benzyl phthalate (BBP), Dibutyl phthalate (DBP), and Diisobutyl phthalate (DIBP) comply with the limits as set by RoHS Directive (EU) 2015/863 amending Annex II to Directive 2011/65/EU.

Signed for and on behalf of
SGS-CSTC Standards Technical Services Co., Ltd. Shenzhen Branch

Tina
Tina Fan
Approved Signatory



Unless otherwise agreed in writing, this document is issued by the Company subject to its General Conditions of Service printed on the reverse side of this document or available at www.sgs.com. The Client's attention is drawn to the limitation of liability, indemnification and jurisdiction clauses defined therein. Any holder of this document is advised that information contained herein reflects the Company's findings at the time of its intervention only and within the limits of the Client's instructions. In any event, the Company's sole responsibility is to its Client and the document does not exonerate parties to a transaction from respecting all their rights and obligations under the transaction documents. This document cannot be reproduced or used in any manner whatsoever without the prior written approval of the Company. Any unauthorized alteration, forgery or falsification of the content or appearance of this document is unlawful and offenders may be prosecuted to the fullest extent of the law. Unless otherwise stated the validity shown in this report refers only to the samples tested.

Attention: To check the authenticity of testing SGS-CSTC Reports & certificates, please contact us at telephone: (86-755) 8307 1443 or website: CN.sgs.com/verify

SGS 检测有限公司 深圳分公司 地址: 深圳市福田区福安路11号 邮编: 518129 电话: (86-755) 25328888 / (86-755) 83071000 传真: (86-755) 25328889 / (86-755) 83071001 电子邮箱: china@sgs.com

Member of the SGS Group (SGS SA)



Test Report No. SZXEC1900530401 Date: 30 Mar 2019 Page 2 of 6

Test Results :

Test Part Description :

Specimen No.	SGS Sample ID	Description
SN1	SZX19-005304.001	Green"PCB"

- Remarks :
- (1) 1 mg/kg = 1 ppm = 0.0001%
 - (2) MDL = Method Detection Limit
 - (3) ND = Not Detected (< MDL)
 - (4) "-" = Not Regulated

RoHS Directive (EU) 2015/863 amending Annex II to Directive 2011/65/EU

Test Method : With reference to IEC 62321-4:2013+A1:2017, IEC62321-5:2013, IEC62321-7-2:2017, IEC 62321-6:2015 and IEC62321-8:2017, analyzed by ICP-OES, UV-Vis and GC-MS.

Test Item(s)	Limit	Unit	MDL	0/1
Cadmium (Cd)	100	mg/kg	2	ND
Lead (Pb)	1,000	mg/kg	2	8
Mercury (Hg)	1,000	mg/kg	2	ND
Hexavalent Chromium (Cr(VI))	1,000	mg/kg	8	ND
Sum of PBBs	1,000	mg/kg	-	ND
Monobromobiphenyl	-	mg/kg	5	ND
Dibromobiphenyl	-	mg/kg	5	ND
Tri bromobiphenyl	-	mg/kg	5	ND
Tetrabromobiphenyl	-	mg/kg	5	ND
Pentabromobiphenyl	-	mg/kg	5	ND
Hexabromobiphenyl	-	mg/kg	5	ND
Heptabromobiphenyl	-	mg/kg	5	ND
Octabromobiphenyl	-	mg/kg	5	ND
Nonabromobiphenyl	-	mg/kg	5	ND
Decabromobiphenyl	-	mg/kg	5	ND
Sum of PBDEs	1,000	mg/kg	-	ND
Monobromodiphenyl ether	-	mg/kg	5	ND
Dibromodiphenyl ether	-	mg/kg	5	ND
Tri bromodiphenyl ether	-	mg/kg	5	ND
Tetrabromodiphenyl ether	-	mg/kg	5	ND
Pentabromodiphenyl ether	-	mg/kg	5	ND



Unless otherwise agreed in writing, this document is issued by the Company subject to its General Conditions of Service printed on the reverse side of this document or available at www.sgs.com. The Client's attention is drawn to the limitation of liability, indemnification and jurisdiction clauses defined therein. Any holder of this document is advised that information contained herein reflects the Company's findings at the time of its intervention only and within the limits of the Client's instructions. In any event, the Company's sole responsibility is to its Client and this document does not exonerate parties to a transaction from respecting all their rights and obligations under the transaction documents. This document cannot be reproduced or used in any manner whatsoever without the prior written approval of the Company. Any unauthorized alteration, forgery or falsification of the content or appearance of this document is unlawful and offenders may be prosecuted to the fullest extent of the law. Unless otherwise stated the validity shown in this report refers only to the samples tested.

Attention: To check the authenticity of testing SGS-CSTC Reports & certificates, please contact us at telephone: (86-755) 8307 1443 or website: CN.sgs.com/verify

SGS 检测有限公司 深圳分公司 地址: 深圳市福田区福安路11号 邮编: 518129 电话: (86-755) 25328888 / (86-755) 83071000 传真: (86-755) 25328889 / (86-755) 83071001 电子邮箱: china@sgs.com

Member of the SGS Group (SGS SA)



ZPMV2.E490354 - WIRING, PRINTED - COMPONENT

Wiring, Printed - Component

See General Information for Wiring, Printed - Component

O-LEADING SUPPLY CHAIN (HK) CO LTD
 ROOM 1205, 12/F
 TAI SANG BANK BLDG
 130-132 DES VOEUS ROAD
 CENTRAL, HONG KONG

E490354

Type	Cond Width		Cond Thk	SS/ DS/ DSO	Max	Max		Meets	C		
	Min	Edge			Area	Solder	Oper			Flame	
	mm(in)	mm(in)	mic(mil)		Diam	Limits	Temp	Class	UL796	T	
Multilayer (mass laminate) printed wiring boards.											
O-LEADING-401	0.1 (0.004)	0.3 (0.012)	34 (1.34)	DS	12.7 (0.5)	260	10	130	V-0	-	
O-LEADING-407	0.08 (0.003)	0.2 (0.008)	17 (0.67)	DS	9.7 (0.4)	260	10	130	V-0	All	
Multilayer printed wiring boards.											
O-LEADING-408	0.125 (0.005)	0.125 (0.005)	12 (0.47) Int:136	DS	50.8 (2.0)	280	20	130	V-0	All	*
Single layer printed wiring boards.											
O-LEADING-002	0.38 (0.015)	1.14 (0.045)	34 (1.34)	SS	19.1 (0.8)	260	10	105	V-0	All	-
O-LEADING-003	0.38 (0.015)	1.14 (0.045)	34 (1.34)	SS	19.1 (0.8)	260	10	130	V-0	▲	-
O-LEADING-033	0.15 (0.006)	0.3 (0.012)	34 (1.34)	SS	25.4 (1.0)	260	10	120	V-0	All	-
O-LEADING-205	0.1 (0.004)	0.3 (0.012)	34 (1.34)	DS	69.6 (2.7)	260	10	130	V-0	All	-
O-LEADING-206	0.15 (0.006)	0.33 (0.013)	17 (0.67)	DS	69.6 (2.7)	260	10	130	V-0	All	-
O-LEADING-D01	0.14 (0.006)	0.15 (0.006)	33 (1.30)	DS	25.4 (1.0)	260	10	130	V-0	All	*
O-LEADING-S01	0.25 (0.010)	0.25 (0.010)	17 (0.67)	SS	25.4 (1.0)	260	4	130	V-0	All	*

WIRING, PRINTED - COMPONENT | UL Product iQ

O-LEADING-S02	0.2 (0.008)	0.2 (0.008)	17 (0.67)	SS	25.4 (1.0)	260	4	130	HB	▲	*
O-LEADING-S03	0.25 (0.010)	0.25 (0.010)	34 (1.34)	SS	25.4 (1.0)	260	4	130	V-0	All	*

* - CTI marking is optional and may be marked on the printed wiring board.

Marking: Company name or file number and type designation. May be followed by a suffix to denote factory identification or burning test classification.

并不是所有出现在本数据库中的公司名称和产品都满足了UL跟踪检验服务的要求。只有带有UL标志的产品，才应该被视为经过UL认证，并满足UL跟踪检验服务的要求。注意查看产品上的标志。

UL 允许在线认证目录中所含材料的复制遵循以下条件：1.指南信息、装配、构造、设计、系统和/或认证（文件）必须在不篡改任何数据（或图纸）的情况下完整且无误导性地呈现。2.经 UL 允许从在线认证目录转载“声明必须出现在所提取材料的邻近位置。此外，转载材料必须包含以下格式的版权声明：“© 2019 UL LLC”

Prozessfähigkeit

Produktionsmöglichkeiten für Leiterplatten

Ebenenanzahl	1Layer-32Layer
Fertige Kupferdicke	1 / 3oz-12oz
Min. Linienbreite / Abstand intern	3,0 mil / 3,0 mil
Min. Linienbreite / Abstand extern	4,0 mil / 4,0 mil
Maximales Seitenverhältnis	10: 1
Plattendicke	0,2 mm bis 5,0 mm
Maximale Panelgröße (Zoll)	635 * 1500 mm
Minimale Bohrlochgröße	4mil
Plated Hole Tolerance	+/- 3mil
Blind / Buried Vias (All-Typen)	JA
Über Füllung (leitend, nicht leitend)	JA
Basismaterial	FR-4, FR-4high Tg, Halogenfreies Material, Rogers, Aluminiumbasis, Polyimid, schweres Kupfer
Oberflächenbeschaffenheit	HASL, OSP, ENIG, HAL-LF, Immersionssilber, Immersionsdose, Goldfinger, Carbon-Tinte

SMT-Produktionskapazitäten

Leiterplattenmaterial	FR-4, CEM-1, CEM-3, Platte auf Aluminiumbasis
Maximale Leiterplattengröße	510 x 460 mm
Min. Leiterplattengröße	50x50mm
Leiterplattenstärke	0,5 mm - 4,5 mm
Plattendicke	0,5-4 mm
Min. Komponentengröße	0201
Standard-Chipgrößenkomponente	0603 und größer
Komponente maximale Höhe	15mm
Min. Lead Pitch	0,3 mm
Min BGA Ball Pitch	0,4 mm
Platzierungsgenauigkeit	+/- 0,03 mm

Verpackung & Lieferung

Shipping service



Quick Turn Lead Time		
Layer Count:	Lead Tim	Special Requirement
1L/2L	2-3days	24 Hours,48 Hours
4L	3-4days	48 Hours
6L	4-5days	72 Hours
8L	5-6days	NA
10L	6-7days	NA
12L	7-8days	NA
14L	8-9days	NA

Standard Lead Time		
Layer Count:	Sample Lead Time	Volume order lead time
2L	4 days	10 days
4L	5 days	11 days
6L	6 days	12 days
8L	8 days	14 days
10L	10 days	16 days
12L	12 days	18 days
14L	14 days	20 days
16-32L	18 days	24 days

FAQ

1. Wie sichert O-Leading die Qualität?

Unser hoher Qualitätsstandard wird mit Folgendem erreicht.

- 1.1 Der Prozess wird streng nach den Normen ISO 9001: 2008 kontrolliert.
- 1.2 Umfangreicher Einsatz von Software bei der Verwaltung des Produktionsprozesses
- 1.3 Prüfgeräte und Werkzeuge nach dem neuesten Stand der Technik. Z.B. Flugsonde, Röntgeninspektion, AOI (Automated Optical Inspector) und ICT (In-Circuit-Test).
- 1.4. Engagiertes Qualitätssicherungsteam mit Fehlerfallanalyseprozess
- 1.5. Kontinuierliche Schulung und Ausbildung des Personals

2. Wie hält O-Leading Ihren Preis wettbewerbsfähig?

In den letzten zehn Jahren hatten sich die Preise für viele Rohstoffe (z. B. Kupfer, Chemikalien) verdoppelt, verdreifacht oder vervierfacht. Der RMB in chinesischer Währung hatte gegenüber dem US-Dollar um 31% aufgewertet. Auch unsere Arbeitskosten sind deutlich gestiegen.

O-Leading hat jedoch unsere Preise stabil gehalten. Dies liegt ganz bei unseren Innovationen zur Kostensenkung, Vermeidung von Abfällen und Verbesserung der Effizienz. Unsere Preise sind in der Branche bei gleichem Qualitätsniveau sehr wettbewerbsfähig.

Wir glauben an eine Win-Win-Partnerschaft mit unseren Kunden. Unsere Partnerschaft wird für beide Seiten von Vorteil sein, wenn wir Ihnen Kosten und Qualität bieten können.

3. Welche Arten von Boards kann O-Leading verarbeiten?

Gängige FR4-, High-TG- und halogenfreie Platten, Rogers, Arlon, Telfon, Aluminium / Kupfer-basierte Platten, PI usw.

4. Welche Daten werden für die PCB & PCBA-Produktion benötigt?

4.1 Stückliste mit Referenzbezeichnungen: Komponentenbeschreibung, Herstellername und Teilenummer.

4.2 PCB Gerber-Dateien.

4.3 PCB-Fertigungszeichnung und PCBA-Montagezeichnung.

4.4 Testverfahren.

4.5 Alle mechanischen Einschränkungen, wie z. B. Anforderungen an die Montagehöhe.

5. Was ist der typische Prozessablauf für mehrschichtige Leiterplatten?

Materialschneiden → innerer Trockenfilm → inneres Ätzen → innerer AOI → Mehrfachbindung → Schichtaufbau Pressen → Bohren → PTH → Plattenbeschichtung → äußerer Trockenfilm → Musterbeschichtung → äußeres Ätzen → äußerer AOI → Lötmaske → Komponentenmarkierung → Oberflächenbeschaffenheit → Arbeitsplan → E / T → Sichtprüfung.

6. Was sind die wichtigsten Ausrüstungen für die HDI-Herstellung?

Die Liste der wichtigsten Ausrüstungsgegenstände lautet wie folgt: Laserbohrmaschine, Pressmaschine, VCP-Linie, automatische Belichtungsmaschine, LDI usw.

Die Geräte, die wir haben, sind die besten in der Branche, Laserbohrmaschinen sind von Mitsubishi und Hitachi, LDI-Maschinen sind von Screen (Japan), automatische Belichtungsmaschinen sind ebenfalls von Hitachi, alle sorgen dafür, dass wir die technischen Anforderungen unserer Kunden erfüllen können.

7. Wie viele Arten von Oberflächenbeschichtungen kann O-Blei verarbeiten?

O-the Leader verfügt über die gesamte Palette an Oberflächen, wie z. B.: ENIG, OSP, LF-HASL, Vergoldung (weich / hart), Immersionsilber, Zinn, Versilberung, Immersionsverzinnung, Carbon-Tinte usw. OSP, ENIG, OSP + ENIG, die üblicherweise auf dem HDI verwendet werden. Wir empfehlen normalerweise die Verwendung eines Clients oder OSP OSP + ENIG, wenn die BGA-PAD-Größe weniger als 0,3 mm beträgt.

8. Was sind Ihre Fähigkeiten für FPC? Kann O-Leading auch SMT-Dienste anbieten?

O-Leading kann FPC von einer Schicht bis zu 8 Schichten herstellen. Die Größe der Arbeitsplatte kann bis zu 2000 mm * 240 mm betragen. Einzelheiten finden Sie auf der Seite „Flex Capability“.

Wir bieten unseren Kunden auch einen SMT-One-Stop-Service.

9. Was sind die Hauptfaktoren, die den Preis von Leiterplatten beeinflussen?

Material;

Oberflächenveredlung;

Technologische Schwierigkeit;

Unterschiedliche Qualitätskriterien;

PCB-Eigenschaften;

Zahlungsbedingungen;

Verschiedene Herstellungsländer.

10. Was ist die Definition von PCB, PWB und FPC und was ist der Unterschied?

PCB ist die Abkürzung für Printed Circuit Board.

PWB ist die Abkürzung für Printed Wire Board und hat dieselbe Bedeutung wie Printed Circuit Board.

FPC ist die Abkürzung für Flexible Printed Board.

11. Welche Faktoren sollten bei der Auswahl des Materials für eine Leiterplatte berücksichtigt werden?

Die folgenden Faktoren sollten bei der Auswahl des Materials für die Leiterplatte berücksichtigt werden:
Der Tg-Wert des Materials sollte größer als die Betriebstemperatur sein.

Material mit niedrigem CTE weist eine gute Leistung der thermischen Stabilität auf;

Gute Wärmewiderstandsleistung: Normalerweise müssen Leiterplatten mindestens 50 Sekunden lang 250 °C widerstehen.

Gute Ebenheit; In Anbetracht der elektrischen Eigenschaften wird auf Hochfrequenz-Leiterplatten

Material mit geringem Verlust und hoher Permittivität verwendet; Polyimidglasfasersubstrat für flexible Leiterplatten; Metallkern wird verwendet, wenn das Produkt strenge Anforderungen an die

Wärmeableitung stellt.

12. Was sind die Vorzüge der rigid-flex-Leiterplatte von O-Leading?

Die Rigid-Flex-Platine von O-Leading hat die Eigenschaften von FPC und PCB und kann daher in einigen speziellen Produkten verwendet werden. Ein Teil ist flexibel, während der andere Teil starr ist. Dies kann dazu beitragen, den Innenraum des Produkts zu schonen, das Produktvolumen zu reduzieren und die Leistung zu verbessern.

13. Wie führen Sie die Impedanzberechnung durch?

Das Impedanzsteuersystem wird mit einigen Testcoupons, dem SI6000 soft und dem CITS 500s von POLAR INSTRUMENTS durchgeführt.

Das Gerät misst die Impedanz auf einem repräsentativen Gleiskonfigurationscoupon, von dem der Kunde uns einen bestimmten Wert und eine bestimmte Toleranz gegeben hat.