

## Produktbeschreibung

Haushaltsberührungslose Hände Sanitizer Elektrisches Schaumspray Automatisches Infrarot-Sensor Seifenspender Handschaumspray Für Zuhause Hotel

Anwendung: HOTEL, Villa, WOHNUNG, BÜROGEBÄUDE, KRANKENHAUS, Schule, Einkaufszentrum, Sportstätten, Freizeiteinrichtungen, Supermarkt, LAGER, WORKSHOP, Park, Bauernhaus, Innenhof

|                    |   |
|--------------------|---|
| <b>Produktname</b> | <b><u>Automatischer Händedesinfektionsspender</u></b> |
| Material           | ABS + PP  |
| Gewicht            | 255G  |
| Kapazität          | 350 ml  |
| Aufladen           | USB wiederaufladbar                                   |
| Feature            | Automatischer Sensor                                  |



**Feature.**

**Automatisch & berührungslos:** Dieser speziell eingebaute Infrarotsensor für Schaumseifenspender ist freihändig, hält Keime fern und trägt dazu bei, dass Sie und Ihre Familie gesund bleiben. Außerdem wird das Händewaschen für Kinder interessanter!

**Sicherer für Familien / Gäste:** Stellen Sie unseren Händedesinfektionsspender, der vollständig mit Händedesinfektionsgel gefüllt ist, in die Tür und lassen Sie Familien und Gäste, die täglich Vorräte kaufen, ihre Hände desinfizieren, bevor sie hereinkommen. Weigern Sie sich, den Virus nach Hause zu bringen.

**MATERIAL:** ABS umweltfreundliches, schmutzabweisendes Material, sicher und korrosionsbeständig; Infrarot-präzise und intelligente Erfassung, auslaufsicherer Gummiauslass; kein Geräusch.

**Bequemer:** Verwenden Sie dies [Händedesinfektionsgel-Seifenspender](#) an allen Eingängen von

öffentlichen Orten, um ihre Hände zu desinfizieren, bevor Sie in Ihr Restaurant, Hotel, Krankenhaus kommen ... Sie sind mit Händedesinfektionsgel anstelle von Schaumseife gefüllt, sodass Sie sie überall hinstellen können, wo Sie möchten, da Sie Ihre Hände nicht waschen müssen Wasser.

NEW OPTION FOR CLEANING

# **AUTOMATIC INDUCTION HAND-WASHING MACHINE**

The essence of natural plants  
nourishes and cares for your hands  
Contact-free, More at ease



Hand-washing machine x 1  
Antibacterial effervescent tablets x 1

## INTELLIGENT TECHNOLOGY IMPROVE YOUR QUALITY OF LIFE



Near-field  
infrared sensing



0.25s  
Rapid  
bubbling



No contact  
more hygienic



40  
DAYS  
40 days of  
continuous use



Small  
Small and free  
installation



ABS  
Material

FULLY AUTOMATIC HAND-WASHING MACHINE  
CARE FOR THE HEALTH OF THE WHOLE FAMILY





Just stretch out your hands, the rich and dense foam can help you clean effectively

**AUTOMATIC INDUCTION**

# EFFECTIVELY INHIBIT HARMFUL BACTERIA TAKE CARE OF CHILDREN'S HEALTH

Effectively remove 5 major bacteria  
Deeply clean pores  
Gentle care for every inch of the child's skin





E.coli



Staphylococcus  
aureus



Pseudomonas  
aeruginosa



Candida  
albicans



salmonella

## **CHARGING 3 HOURS CAN BE USED CONTINUOUSLY FOR 40 DAYS**

Reasonably control the amount of foam  
350ml large capacity design  
can be used 500 times  
to meet the family's 30-day dosage







Near-field  
infrared sensing



0.25S Rapid  
bubbling

DEEP CLEAN

## **DENSE AND RICH FOAM PENETRATES INTO PORES FOR DEEP CLEANSING**

The dense foam can better cover the skin's epidermis and reach the fine pores for deep cleaning





## ONE MACHINE IS VERSATILE LIQUID CAN BE CHANGED FREELY

A replaceable solution bottle at the bottom makes it easy  
to inject different hand sanitizers  
making it easier to add  
various hand sanitizers you have purchased



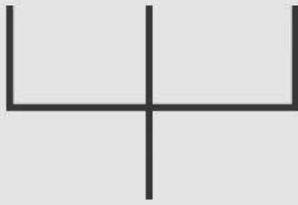

Hand sanitizer 3:7 tap water  
Shake evenly to allow  
hand soap to penetrate and dilute

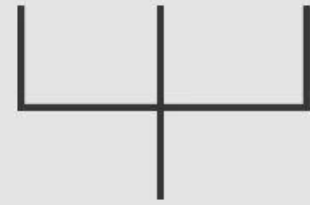

Detergent 3:7 tap water  
Shake evenly to allow hand  
soap to penetrate and dilute

\*Effervescent tablets can be replaced with liquid soap or dishwashing liquid  
The ratio is for reference only, the effect of self-provisioning is more suitable

MOISTURIZING FUNCTION

## ANTIBACTERIAL MOISTURIZING CLEANSING

Choose a slightly acidic formula  
close to the pH of human skin  
With moisturizing function  
Glycerin made from natural oil, mild texture



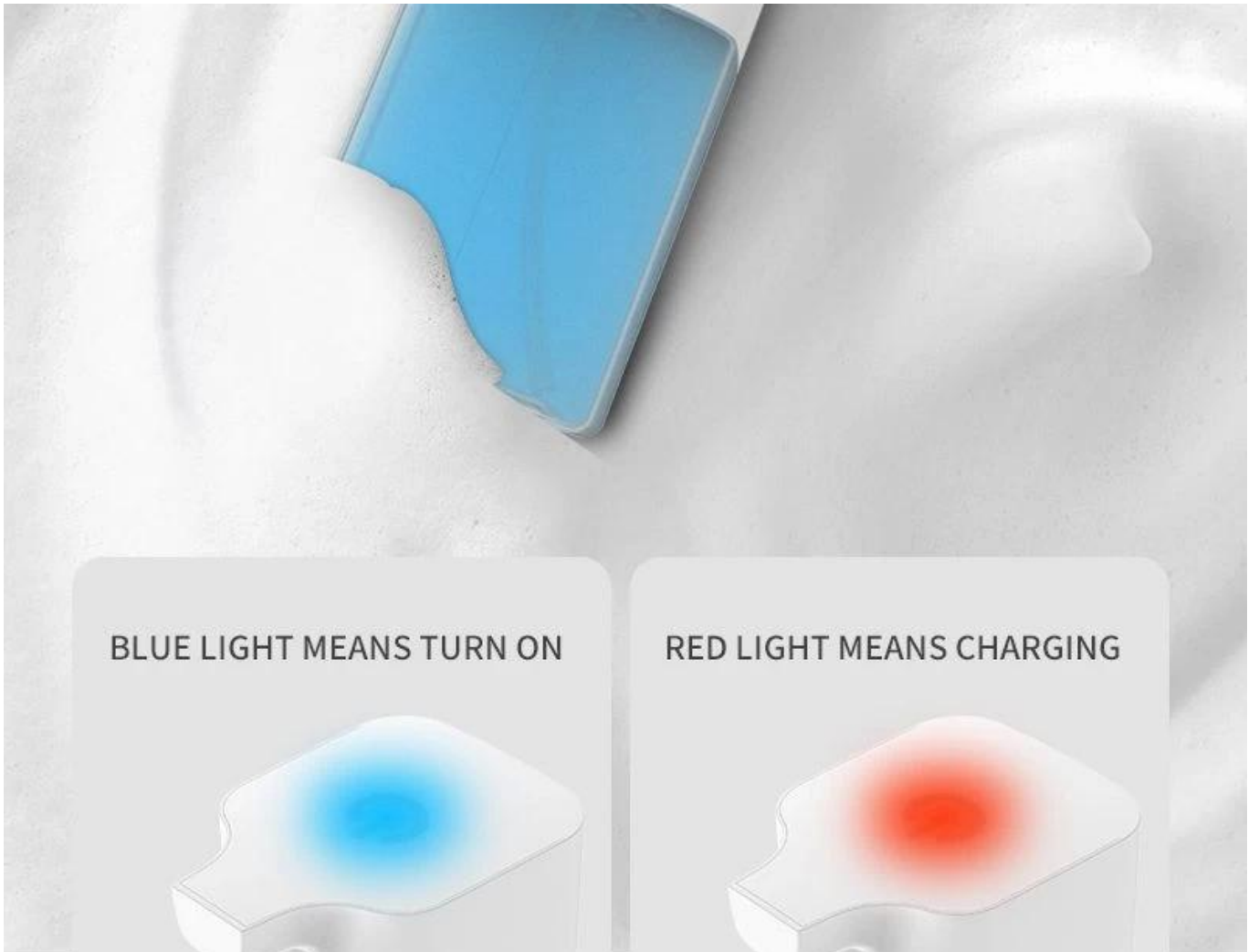

BLUE LIGHT MEANS TURN ON



RED LIGHT MEANS CHARGING



Inhibit bacteria  
insist on daily hand washing

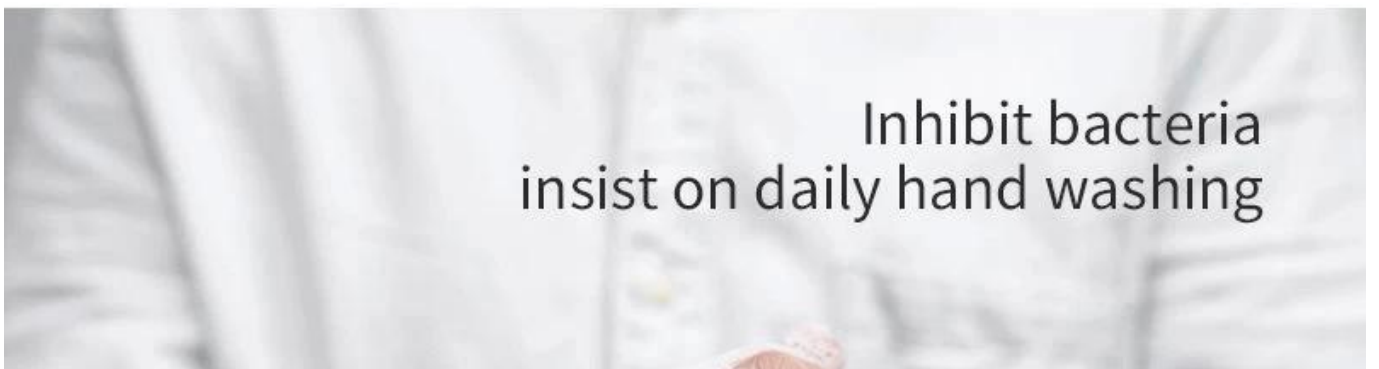



## **MINIATURE HIGH EFFICIENCY MOTOR LOW POWER CONSUMPTION, QUIETER**

The selected miniature high-efficiency motor not only has a high foaming efficiency but also does not disturb the noise during use



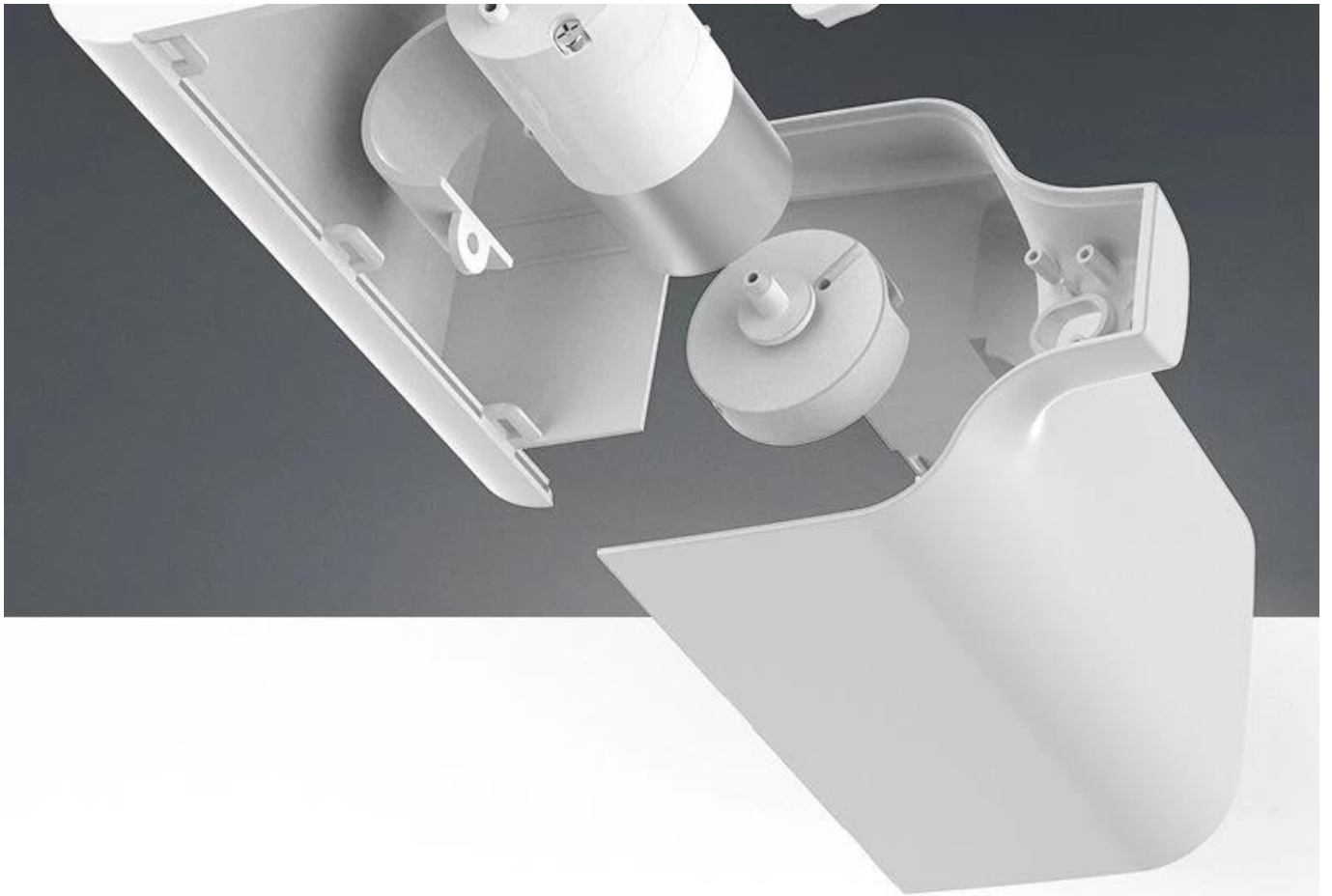

**SCANDINAVIAN MINIMALIST DESIGN**  
**SMALL SIZE**  
**SUITABLE FOR VARIOUS ENVIRONMENTS**

The bottle of hand sanitizer is made of high-grade frosted material  
Clear and clean at any time to check the use of the situation.





## PRODUCT INFORMATION

Product Name: Induction foam hand washing machine

Rated voltage: 5V

Rated power: 15W

Capacity: 350ml

Applicable scene:

Material: ABS

Home cleaning, dormitory



PICTURE COLOR IS FOR REFERENCE ONLY  
PLEASE REFER TO THE ACTUAL PRODUCT

## PRODUCT DETAILS

**TOUCH TO  
TURN ON**



**ABS  
MATERIAL**



## USB CHARGING PORT



## INSTALLATION STEPS OF HAND SANITIZER



Remove concentrated effervescent tablets



Break the concentrated effervescent tablet in half



Dilute the concentrated effervescent tablets in a cup



Put the diluted solution in the solution bottle



Tighten the cap and shake gently



After installation you can use



## Verpackung & Versand

### Lieferanten von Desinfektionsspendern für elektrische Sensoren

#### Verpackungsmaß:

60 Stück / Karton

Kartonmaß: 8 \* 14 \* 22 cm

Brutto-W: 22,5 kg / Karton

**HS-Code: 8509809000**

#### Verpackung & Lieferung

|                     |   |
|---------------------|---|
| Einheiten verkaufen | Einzelexemplar  |
| Einzelpackungsgröße | 8 x 14 x 22 cm  |
| Einzelbruttogewicht | 0,500 kg  |
| Pakettyp:           | 30 Stück pro Karton<br>Produktgröße: 7,5 * 9,7 * 20 cm<br>Innenverpackungsgröße: 8 * 14 * 22 cm, 0,35 kg<br>Äußere Packungsgröße: 58 * 42 * 68 cm, GW 22,5 kg |

#### Vorlaufzeit:

|                   |       |         |          |                   |
|-------------------|-------|---------|----------|-------------------|
| Menge (Einheiten) | 1-100 | 101-500 | 501-1000 | > 1000            |
| Menge (Einheiten) | 5     | 7       | 10       | Verhandelt werden |

#### BildBeispiel:

hotel, KTV and other places

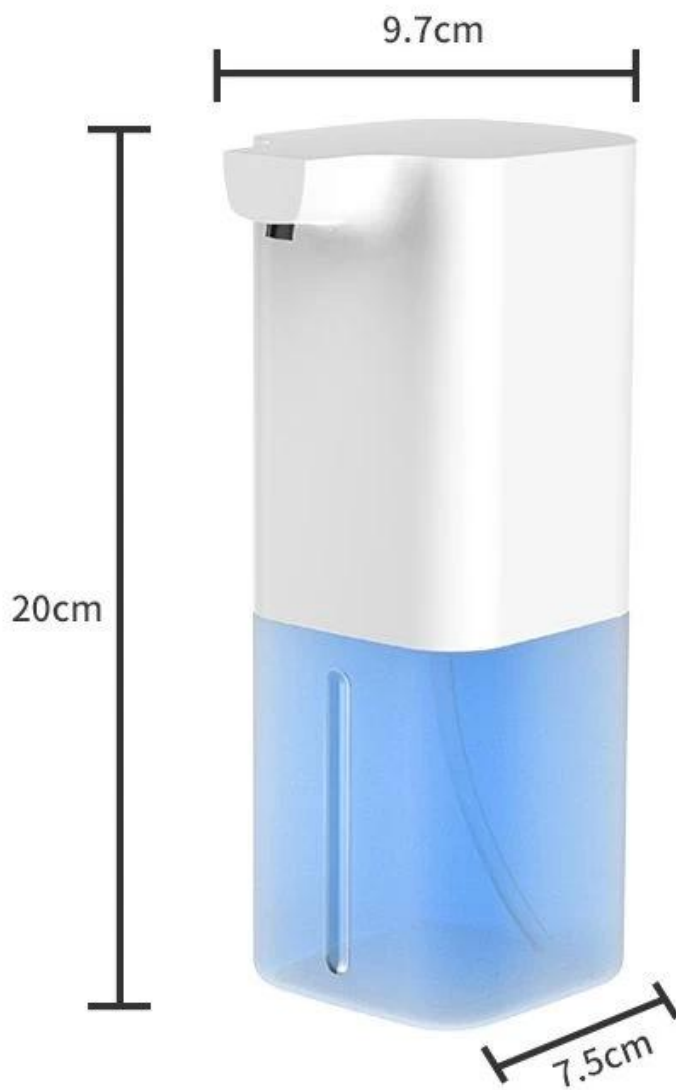

Marine incense

=



Effervescent tablets



MOIST CARE

# NORDIC SIMPLE DESIGN

Marine incense/Osmanthus/Rose fragrance/Lemon scent

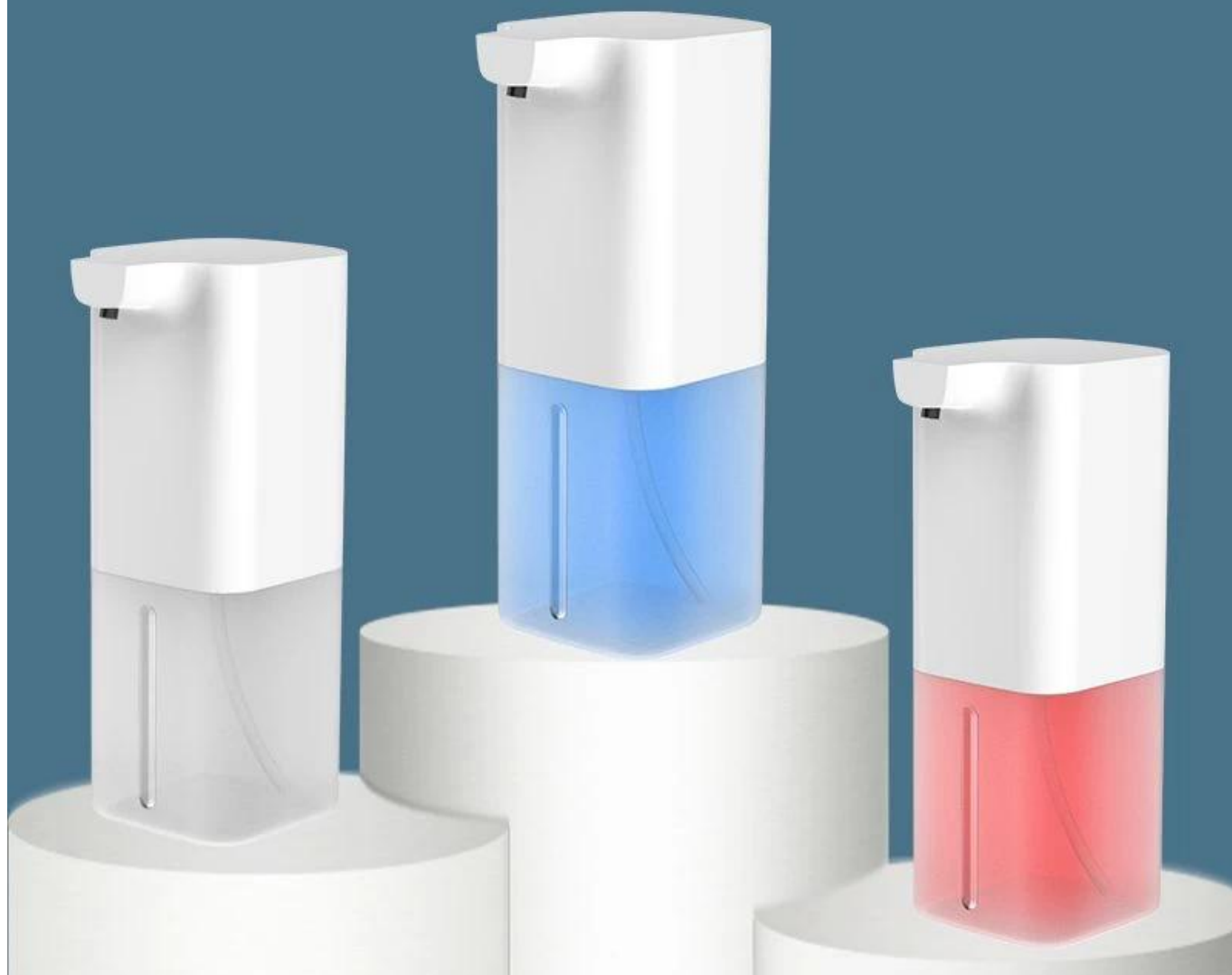

## FAQ

F: Wie kann ich die Proben des automatischen Seifenspenders erhalten, um Ihre Qualität zu überprüfen?

A: Musterbestellung ist verfügbar, kann per Express versendet werden, Sie erhalten sie in 3-7 Tagen.

F: Was kann ich den Preis bekommen?

A: Wir zitieren normalerweise innerhalb von 24 Stunden, nachdem wir Ihre Anfrage erhalten haben. Wenn Sie dringend den Preis erhalten möchten, teilen Sie uns dies bitte in Ihrer E-Mail mit, damit wir Ihre Anfrage als Priorität betrachten.

F: Wie lautet Ihre Lieferfrist?

A: Wir akzeptieren EXW-, FOB Shenzhen- oder CIF-Zielhäfen. Sie können diejenige auswählen, die die istam bequemsten oder kostengünstigsten für Sie.

F: Was ist mit der Vorlaufzeit für die Massenproduktion?

A: Ehrlich gesagt hängt es von der Bestellmenge und der Jahreszeit ab, in der Sie die Bestellung aufgeben. Die Musterbestellung erfolgt innerhalb von 2 Tagen. OEM / OEM-Bestellungen benötigen zusätzliche Zeit.