

## Popis výrobku

Bezdotykový dezinfekční prostředek na ruce pro domácnost Elektrický pěnový sprej Automatický infračervený senzor Dávkořač mýdla Ruční pěnový sprej pro domácí hotel

Použití: HOTEL, vila, APARTMÁN, KANCELÁŘSKÁ BUDOVA, NEMOCNICE, škola, nákupní středisko, sportoviště, zařízení pro volný čas, supermarket, SKLAD, WORKSHOP, park, statek, nádvoří

<b>jméno výrobku</b>	<b><a href="#">Automatický dávkovač dezinfekce rukou</a></b>
Materiál	ABS + PP
Hmotnost	255G
Kapacita	350 ml
Nabíjení	USB dobíjecí
Vlastnosti	Automatický senzor



### **Vlastnosti.**

**Automatické a bezdotykové:** Tento dávkovač pěnového mýdla, speciálně zabudovaný infračervený senzor, hands free, udržuje pryč bakterie a pomáhá udržovat zdraví pro vás a vaši rodinu. Kromě toho se mytí rukou stává pro děti zajímavější věcí!

**Bezpečnější pro rodiny / hosty:** Umístěte náš dávkovač na dezinfekci rukou plně naplněný gelem na dezinfekci rukou ve dveřích, nechte rodiny a hosty, kteří si chodí kupovat denní zásoby, dezinfikovat ruce, než přišli. Odmítněte si vzít virius domů.

**MATERIÁL:** ABS šetrný k životnímu prostředí, špinavý materiál, bezpečný a odolný proti korozi; infračervené přesné a inteligentní snímání, nepropustný gumový vývod; žádný hluk.

**Přijatelnější:** Pomocí tohoto [dávkovač gelového mýdla na dezinfekci rukou](#) na všech vchodech na veřejných místech, abyste si před příchodem do restaurace, hotelu, nemocnice dezinfikovali

ruce ... Jsou naplněny gelem na dezinfekci rukou spíše než pěnovým mýdlem, takže si je můžete dát kamkoli chcete, protože si nemusíte umýt ruce voda.

NEW OPTION FOR CLEANING

# **AUTOMATIC INDUCTION HAND-WASHING MACHINE**

The essence of natural plants  
nourishes and cares for your hands  
Contact-free, More at ease



Hand-washing machine x 1  
Antibacterial effervescent tablets x 1

## INTELLIGENT TECHNOLOGY IMPROVE YOUR QUALITY OF LIFE



Near-field  
infrared sensing



Rapid  
bubbling



No contact  
more hygienic



40 days of  
continuous use



Small and free  
installation



ABS  
Material

FULLY AUTOMATIC HAND-WASHING MACHINE  
CARE FOR THE HEALTH OF THE WHOLE FAMILY





Just stretch out your hands, the rich  
and dense foam can help you clean effectively

**AUTOMATIC INDUCTION**

# EFFECTIVELY INHIBIT HARMFUL BACTERIA TAKE CARE OF CHILDREN'S HEALTH

Effectively remove 5 major bacteria  
Deeply clean pores  
Gentle care for every inch of the child's skin





E.coli



Staphylococcus  
aureus



Pseudomonas  
aeruginosa



Candida  
albicans



salmonella

## **CHARGING 3 HOURS CAN BE USED CONTINUOUSLY FOR 40 DAYS**

Reasonably control the amount of foam  
350ml large capacity design  
can be used 500 times  
to meet the family's 30-day dosage







Near-field  
infrared sensing



0.25S Rapid  
bubbling

DEEP CLEAN

## **DENSE AND RICH FOAM PENETRATES INTO PORES FOR DEEP CLEANSING**

The dense foam can better cover the skin's epidermis and reach the fine pores for deep cleaning





## ONE MACHINE IS VERSATILE LIQUID CAN BE CHANGED FREELY

A replaceable solution bottle at the bottom makes it easy  
to inject different hand sanitizers  
making it easier to add  
various hand sanitizers you have purchased



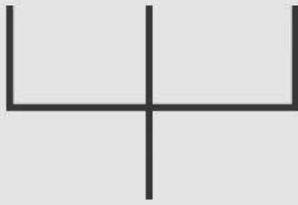

Hand sanitizer 3:7 tap water  
Shake evenly to allow  
hand soap to penetrate and dilute

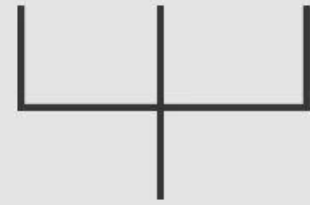

Detergent 3:7 tap water  
Shake evenly to allow hand  
soap to penetrate and dilute

\*Effervescent tablets can be replaced with liquid soap or dishwashing liquid  
The ratio is for reference only, the effect of self-provisioning is more suitable

MOISTURIZING FUNCTION

## ANTIBACTERIAL MOISTURIZING CLEANSING

Choose a slightly acidic formula  
close to the pH of human skin  
With moisturizing function  
Glycerin made from natural oil, mild texture



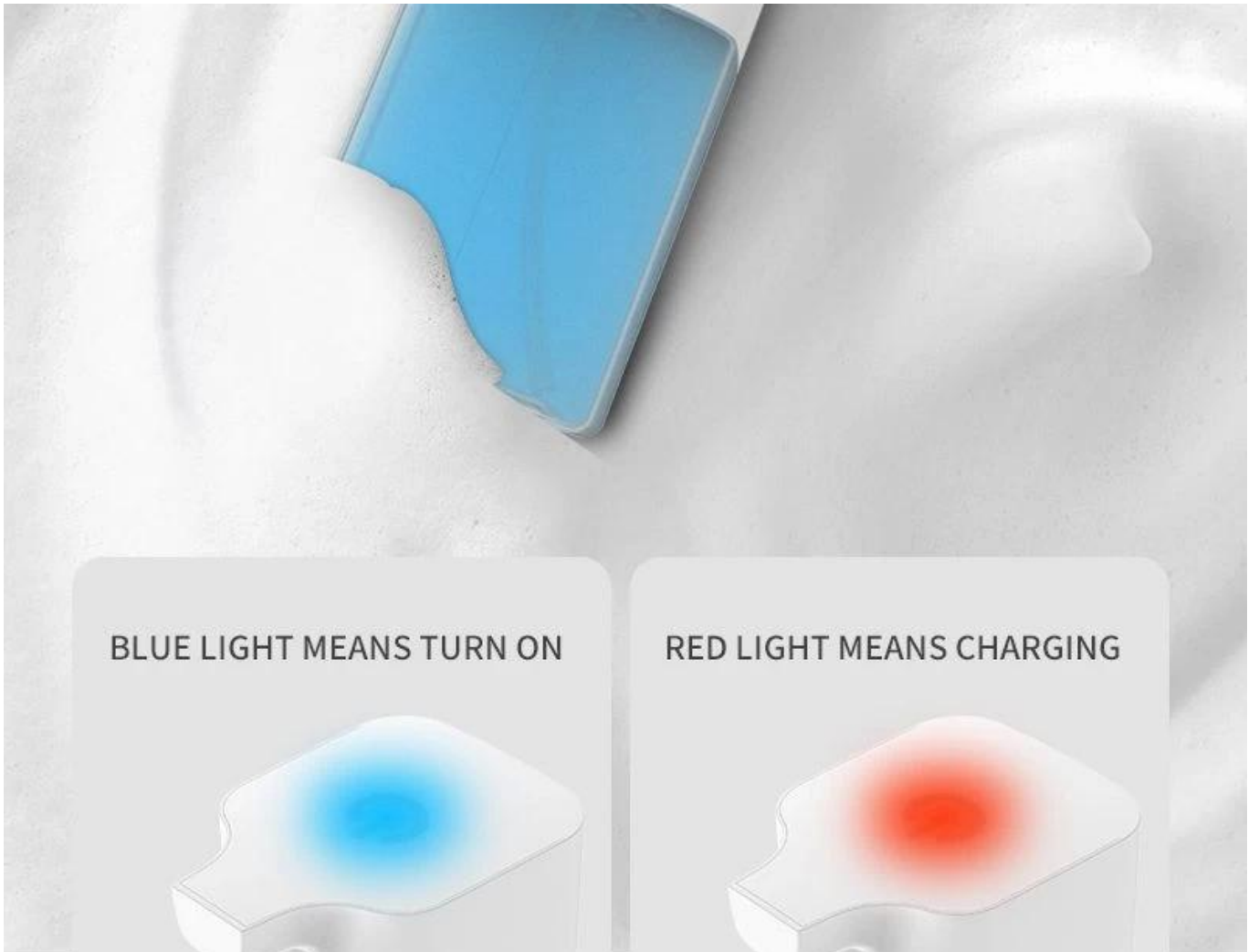

BLUE LIGHT MEANS TURN ON



RED LIGHT MEANS CHARGING



Inhibit bacteria  
insist on daily hand washing

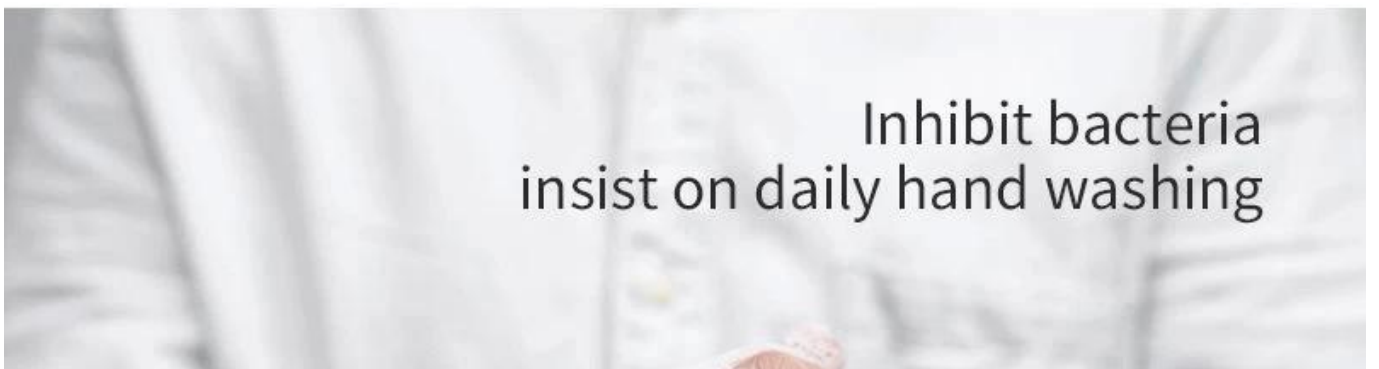



## **MINIATURE HIGH EFFICIENCY MOTOR LOW POWER CONSUMPTION, QUIETER**

The selected miniature high-efficiency motor not only has a high foaming efficiency but also does not disturb the noise during use



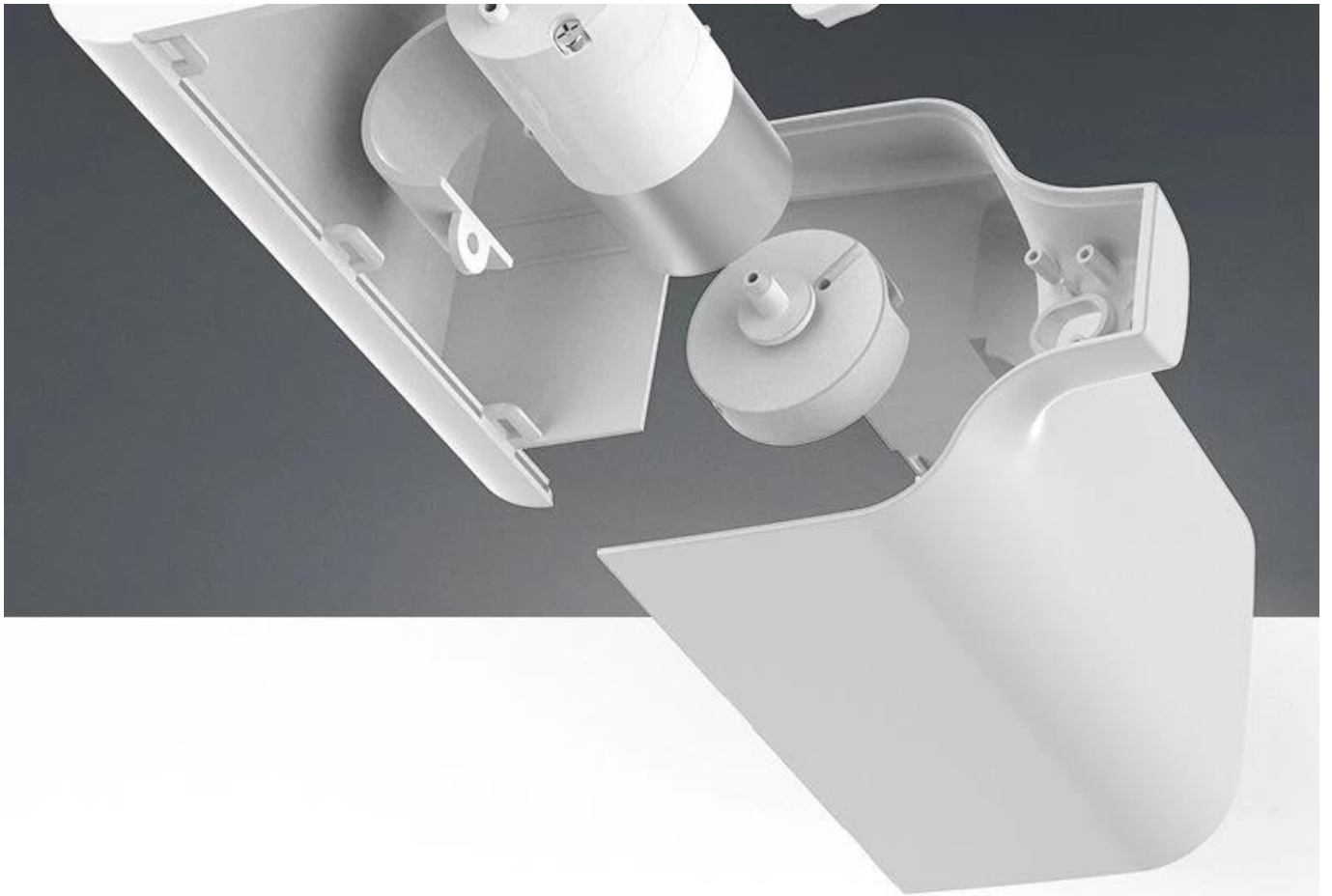

**SCANDINAVIAN MINIMALIST DESIGN**  
**SMALL SIZE**  
**SUITABLE FOR VARIOUS ENVIRONMENTS**

The bottle of hand sanitizer is made of high-grade frosted material  
Clear and clean at any time to check the use of the situation.





## PRODUCT INFORMATION

Product Name: Induction foam hand washing machine

Rated voltage: 5V

Rated power: 15W

Capacity: 350ml

Applicable scene:

Material: ABS

Home cleaning, dormitory



PICTURE COLOR IS FOR REFERENCE ONLY  
PLEASE REFER TO THE ACTUAL PRODUCT

## PRODUCT DETAILS

**TOUCH TO  
TURN ON**



**ABS  
MATERIAL**



## USB CHARGING PORT



## INSTALLATION STEPS OF HAND SANITIZER



Remove concentrated effervescent tablets



Break the concentrated effervescent tablet in half



Dilute the concentrated effervescent tablets in a cup



Put the diluted solution in the solution bottle



Tighten the cap and shake gently



After installation you can use

# CERTIFICATE

## GOOD QUALITY, HEALTHY QUALITY

**CTI 华测检测**  
 报告编号: HZ0010050611Z

MA 160000343904  
 IBC-NRA  
 CNAS 中国认可 深圳 北京 杭州 TESTING CNAS L1110

### 检测报告 Test Report

样品名称: 江西炒米粉手卷片

委托单位: 东莞市尚迪生物科技有限公司

检测类型: 委托检测

华测检测认证集团股份有限公司  
 Centre Testing International Group Co., Ltd.  
 检验检测机构  
 www.ctitest.com



**CTI 华测检测**  
 检测报告  
 报告编号: HZ0010050611Z

样品图片



检验检测机构

检验检测机构名称: 华测检测认证集团股份有限公司  
 检验检测机构地址: 广东省深圳市宝安区西乡街道共传社区华测检测认证集团总部  
 The test report is effective only for the sample and the test items specified in this report unless otherwise stated.  
 检验检测机构地址: 广东省深圳市宝安区西乡街道共传社区华测检测认证集团总部

**CTI 华测检测**  
 检测报告  
 报告编号: HZ0010050611Z 第1页共5页

样品名称	检测标准	CTI 样品编号
江西炒米粉手卷片	GB/T 24095	HZ15050501
规格	规格	/
生产日期	批号	/
样品数量	样品状态	完好
生产厂家	/	/
生产地址	/	/
委托单位	东莞市尚迪生物科技有限公司	
委托单位地址	东莞市寮步镇黄旗北路工业区内二路	
样品接收日期	2022年02月04日	样品检测日期
		2022年02月11日
检测项目	原料、气味、总有效砷、pH(25℃)、甲醛、苯(%)、铅(Pb)、镉(Cd)、甲醇(G388)、二氧化硫、石蜡、菌落总数、霉菌和酵母菌、耐热大肠菌群、金黄色葡萄球菌、铜绿假单胞菌。	
检测依据	GB/T 24095—2017 国家标准《炒手卷》	
检测结果	经检测,有标准指标的项目符合《GB/T 24095—2017 国家标准《炒手卷》》要求。	
检测日期	2022年02月11日	

检验检测机构  
 华测检测认证集团股份有限公司  
 检验检测机构地址: 广东省深圳市宝安区西乡街道共传社区华测检测认证集团总部

编制: 廖仕云 审核: 谢晓红 批准: 刘涛

检测报告  
 第2页共5页

项目	检测项目	检测结果	判定	检验方法
/	甲醛	按 GB 5009.11-2019—2011 中 A 类	合格	GB/T 20096—2002
/	二氧化硫	定量值	合格	GB 4789.42
/	苯	0.04	合格	GB/T 21317—2008
/	铅	0.07	合格	GB 4789.10—2016
合格	镉	0.003	合格	GB 4789.10—2016
合格	铜	0.02	合格	GB 4789.10—2016
合格	镍	0.01	合格	GB 4789.10—2016
合格	砷	0.01	合格	GB 4789.10—2016
合格	大肠菌群	120	合格	GB 4789.10—2016
合格	金黄色葡萄球菌	200	合格	GB 4789.10—2016
合格	霉菌	30	合格	GB 4789.10—2016
合格	耐热大肠菌群	合格	合格	GB 4789.10—2016
合格	菌落总数	合格	合格	GB 4789.10—2016
合格	铜绿假单胞菌	合格	合格	GB 4789.10—2016

检验检测机构  
 华测检测认证集团股份有限公司  
 检验检测机构地址: 广东省深圳市宝安区西乡街道共传社区华测检测认证集团总部

## Balení a doprava

### [dodavatel dávkovače dezinfekčních prostředků na elektrické senzory](#)

#### Rozměry balení:

60ks / karton

Kartonová mouka: 8 \* 14 \* 22 cm

Hrubé hmotnost: 22,5 kg / karton

**Kód HS: 8509809000**

#### Balení a dodání

Prodej jednotek	Jedna položka
Jedna velikost balení	8X14X22 cm
Hrubá hmotnost	0,500 kg
Typ balíčku:	30 jednotek v kartonu velikost produktu: 7,5 * 9,7 * 20 cm velikost vnitřního balení: 8 * 14 * 22 cm, 0,35 kg Vnější velikost balení: 58 * 42 * 68cm, GW 22,5KG

#### Dodací lhůta:

Množství (jednotky)	1-100	101-500	501-1000	> 1000
Množství (jednotky)	5	7	10	Bude sjednáno

#### ObrázekPříklad:

hotel, KTV and other places

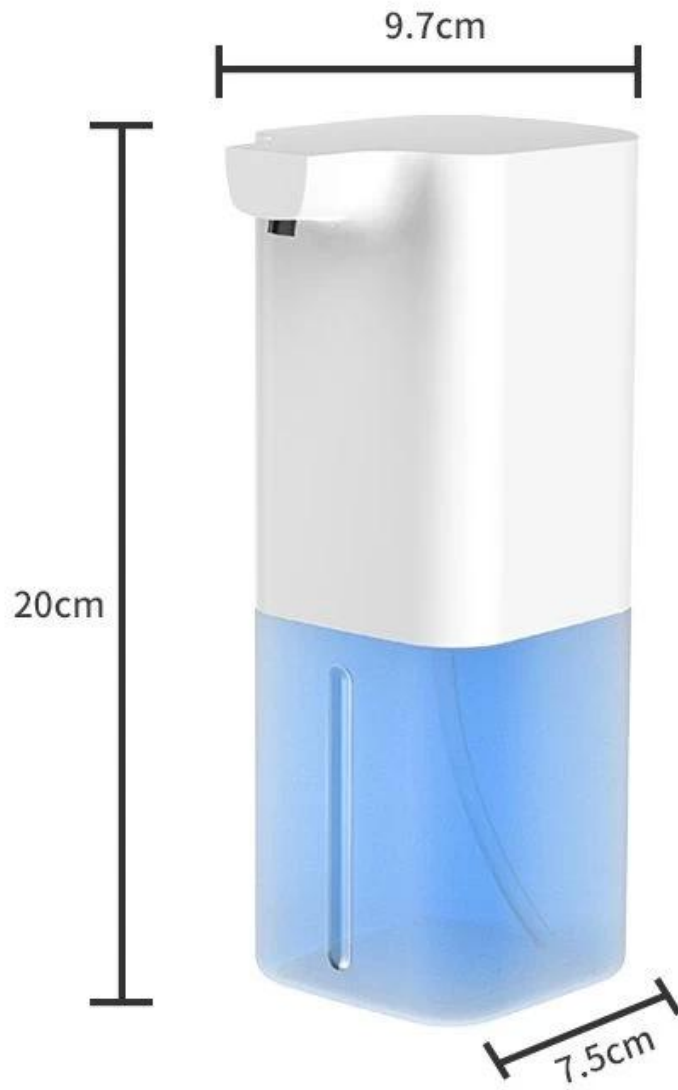

Marine incense

=



Effervescent tablets



MOIST CARE

# NORDIC SIMPLE DESIGN

Marine incense/Osmanthus/Rose fragrance/Lemon scent

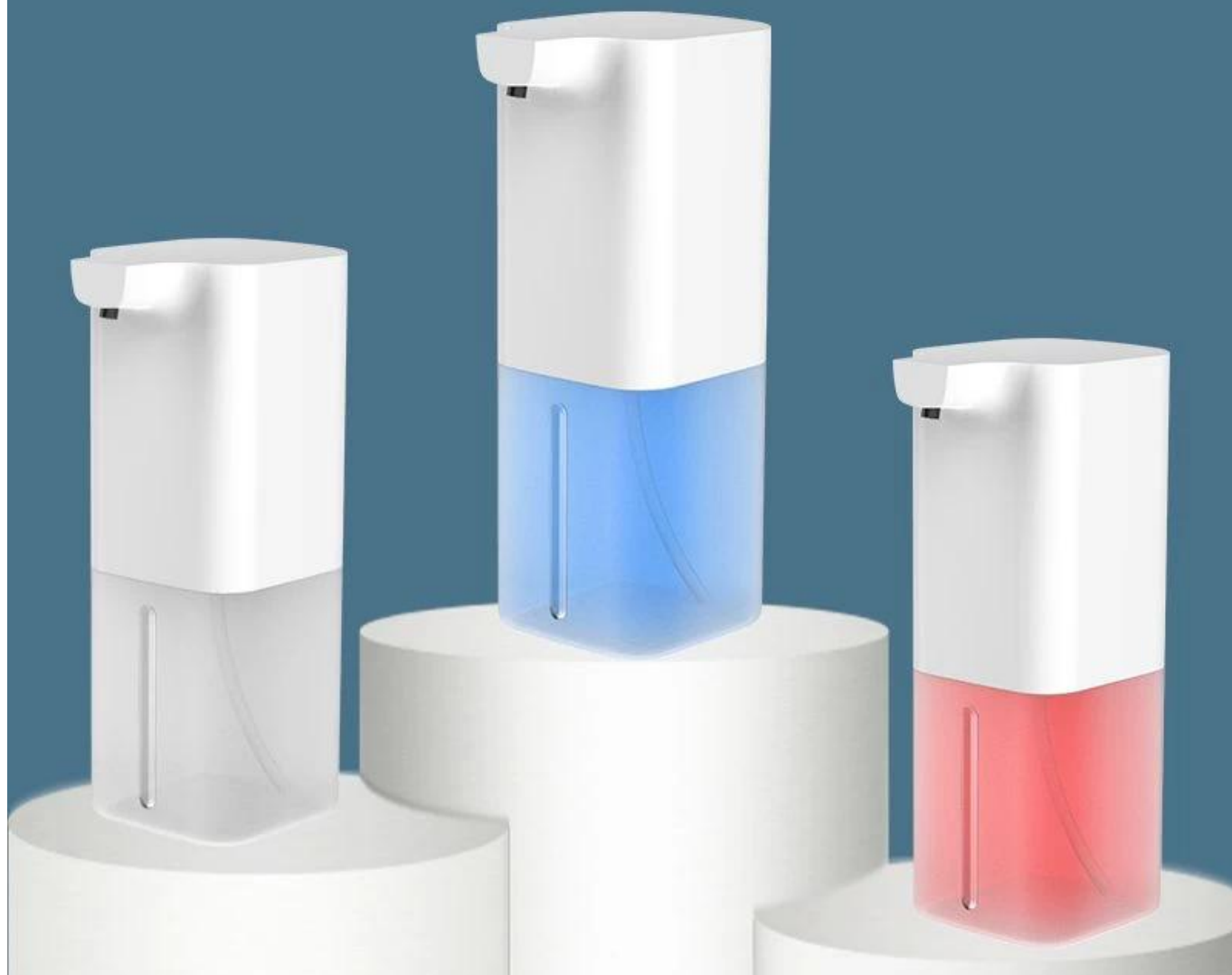

## FAQ

Otázka: Jak mohu získat vzorky automatického dávkovače mýdla ke kontrole vaší kvality?

Odpověď: Ukázková objednávka je k dispozici, lze ji odeslat Express, obdržíte ji za 3-7 dní.

Otázka: Co mohu získat cenu?

Odpověď: Obvykle citujeme do 24 hodin poté, co obdržíme váš dotaz. Pokud jste velmi naléhaví získat cenu, sdělte nám to prosím ve svém e-mailu, abychom váš dotaz považovali za prioritní.

Otázka: Jaký je váš obchodní termín dodání?

Odpověď: Přijímáme cílový port EXW, FOB Shenzhen nebo CIF. Můžete si vybrat ten, který

jenejpohodlnější nebo nejefektivnější pro vás.

Otázka: A co dodací lhůta pro masovou výrobu?

Odpověď: Upřímně, záleží na množství objednávky a sezóně, ve které objednávku zadáváte. Ukázka objednávky je do 2 dnů. Objednávka OEM / OEM bude vyžadovat více času.