

ABS + PP 255 350

ABS + PP 255 350  
ABS + PP 255 350  
ABS + PP 255 350

ABS + PP	255
ABS + PP	350
ABS + PP	255
ABS + PP	350
ABS + PP	255
ABS + PP	350

ABS + PP 255 350



□□□□□□ □□□□ □□□□ □□□□ □□ □□□□ □□□□□ □□□□ □□ □□ □□□□ □□□□ □□□□ □ □□□□□□.

□□□□□□ □□□□□□□□ □□□□□□

NEW OPTION FOR CLEANING

# **AUTOMATIC INDUCTION HAND-WASHING MACHINE**

The essence of natural plants  
nourishes and cares for your hands  
Contact-free, More at ease



Hand-washing machine x 1  
Antibacterial effervescent tablets x 1

## INTELLIGENT TECHNOLOGY IMPROVE YOUR QUALITY OF LIFE



Near-field  
infrared sensing



0.25s  
Rapid  
bubbling



No contact  
more hygienic



40  
DAYS  
40 days of  
continuous use



Small  
Small and free  
installation



ABS  
Material

FULLY AUTOMATIC HAND-WASHING MACHINE  
CARE FOR THE HEALTH OF THE WHOLE FAMILY





Just stretch out your hands, the rich  
and dense foam can help you clean effectively

**AUTOMATIC INDUCTION**

# EFFECTIVELY INHIBIT HARMFUL BACTERIA TAKE CARE OF CHILDREN'S HEALTH

Effectively remove 5 major bacteria  
Deeply clean pores  
Gentle care for every inch of the child's skin





E.coli



Staphylococcus  
aureus



Pseudomonas  
aeruginosa



Candida  
albicans



salmonella

## **CHARGING 3 HOURS CAN BE USED CONTINUOUSLY FOR 40 DAYS**

Reasonably control the amount of foam  
350ml large capacity design  
can be used 500 times  
to meet the family's 30-day dosage







Near-field  
infrared sensing



0.25S Rapid  
bubbling

DEEP CLEAN

## **DENSE AND RICH FOAM PENETRATES INTO PORES FOR DEEP CLEANSING**

The dense foam can better cover the skin's epidermis and reach the fine pores for deep cleaning





## ONE MACHINE IS VERSATILE LIQUID CAN BE CHANGED FREELY

A replaceable solution bottle at the bottom makes it easy  
to inject different hand sanitizers  
making it easier to add  
various hand sanitizers you have purchased



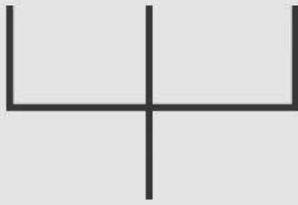

Hand sanitizer 3:7 tap water  
Shake evenly to allow  
hand soap to penetrate and dilute

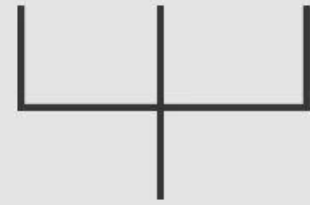

Detergent 3:7 tap water  
Shake evenly to allow hand  
soap to penetrate and dilute

\*Effervescent tablets can be replaced with liquid soap or dishwashing liquid  
The ratio is for reference only, the effect of self-provisioning is more suitable

MOISTURIZING FUNCTION

## ANTIBACTERIAL MOISTURIZING CLEANSING

Choose a slightly acidic formula  
close to the pH of human skin  
With moisturizing function  
Glycerin made from natural oil, mild texture



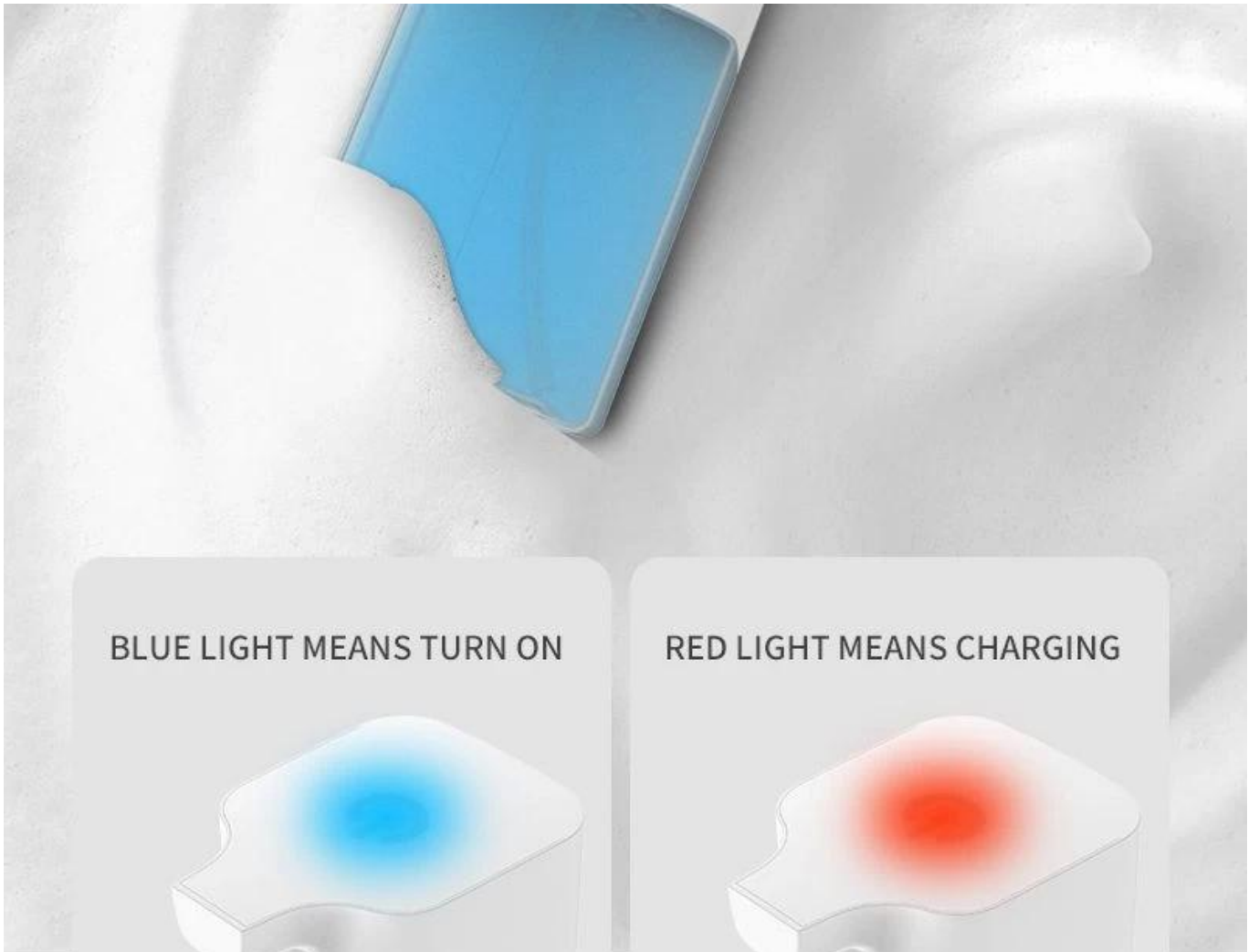

BLUE LIGHT MEANS TURN ON



RED LIGHT MEANS CHARGING



Inhibit bacteria  
insist on daily hand washing

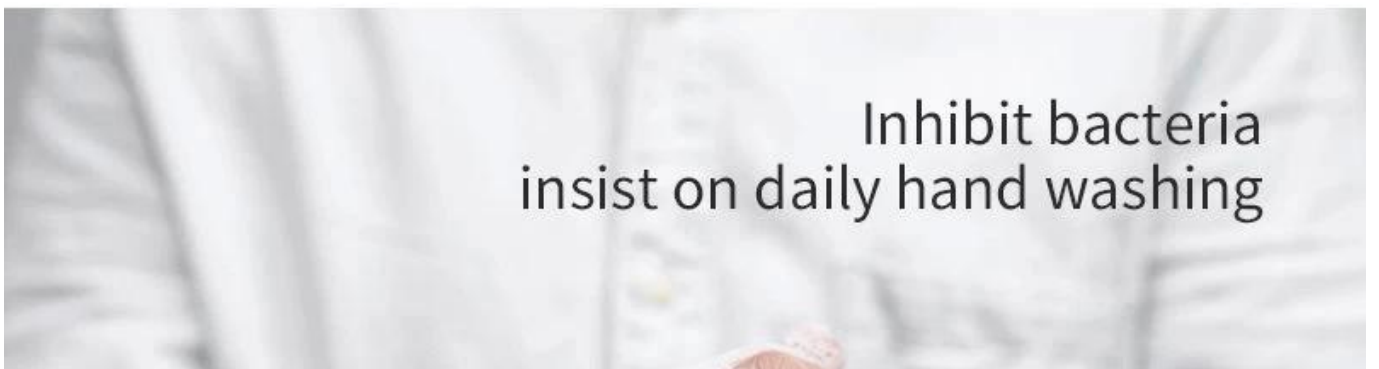



## **MINIATURE HIGH EFFICIENCY MOTOR LOW POWER CONSUMPTION, QUIETER**

The selected miniature high-efficiency motor not only has a high foaming efficiency but also does not disturb the noise during use



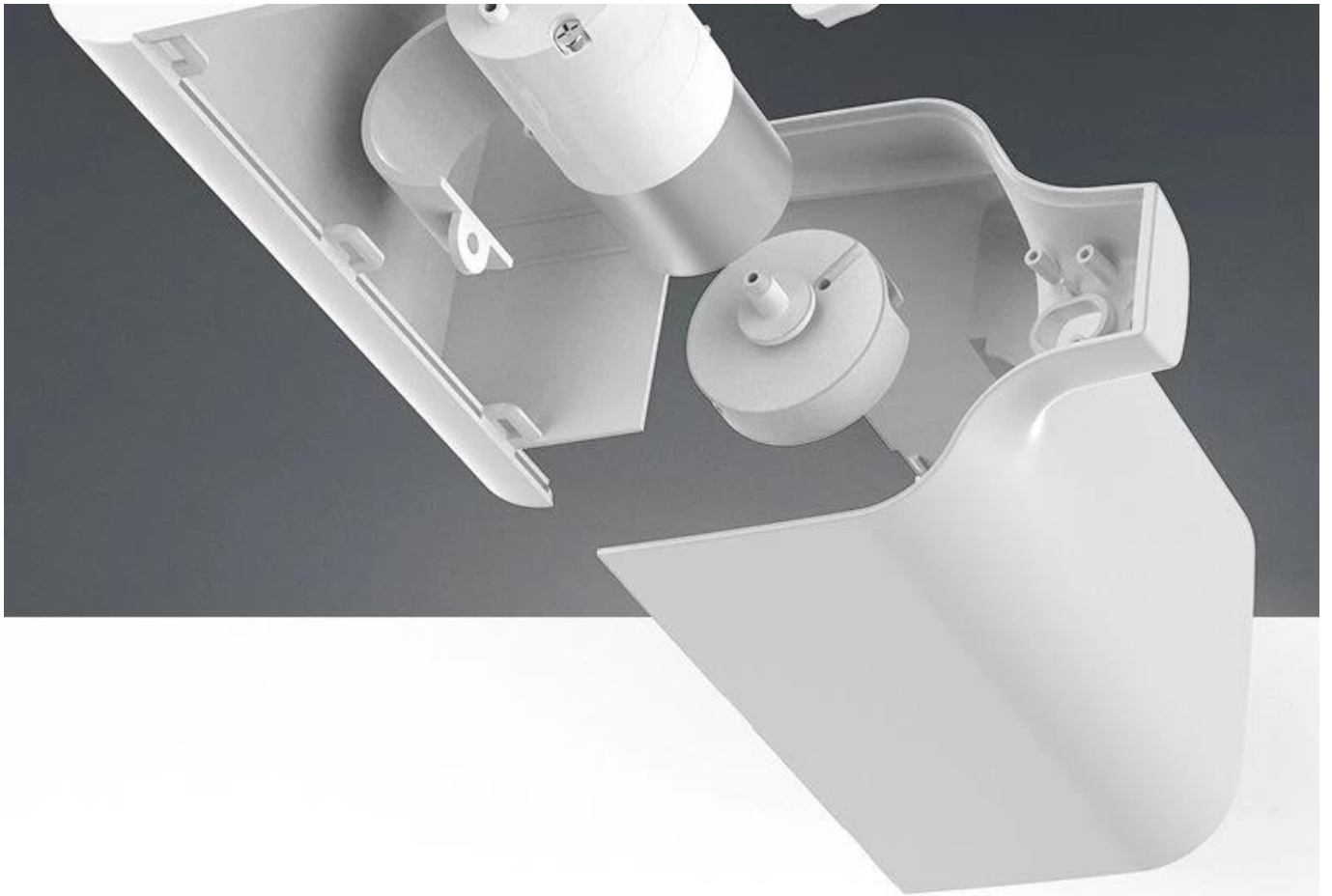

**SCANDINAVIAN MINIMALIST DESIGN**  
**SMALL SIZE**  
**SUITABLE FOR VARIOUS ENVIRONMENTS**

The bottle of hand sanitizer is made of high-grade frosted material  
Clear and clean at any time to check the use of the situation.





## PRODUCT INFORMATION

Product Name: Induction foam hand washing machine

Rated voltage: 5V

Rated power: 15W

Capacity: 350ml

Applicable scene:

Material: ABS

Home cleaning, dormitory



PICTURE COLOR IS FOR REFERENCE ONLY  
PLEASE REFER TO THE ACTUAL PRODUCT

## PRODUCT DETAILS

**TOUCH TO  
TURN ON**



**ABS  
MATERIAL**



## USB CHARGING PORT



## INSTALLATION STEPS OF HAND SANITIZER



Remove concentrated effervescent tablets



Break the concentrated effervescent tablet in half



Dilute the concentrated effervescent tablets in a cup



Put the diluted solution in the solution bottle



Tighten the cap and shake gently



After installation you can use



□□□□□□ □□□□□□

□□□□□□ □□□□:

60 □□□□□ / □□□□

□□ 22 \* 14 \* 8 :□□ □□□□□

□□□□□□ W: 22.5 □□□□□ / □□□

**8509809000** :□□□□□□ □□□□□□ □□□

□□□□□□□□ □□□□□□□□ □□□□□□□□

□□□□□□□□ □□□	□□□□ □□□□
□□□□□□□□ □□□□□□ □□□	8X14X22 □□
□□□□□□□□ □□□□□□□□ □□□□□	0.500 □□□

□□□□□□□□:

hotel, KTV and other places

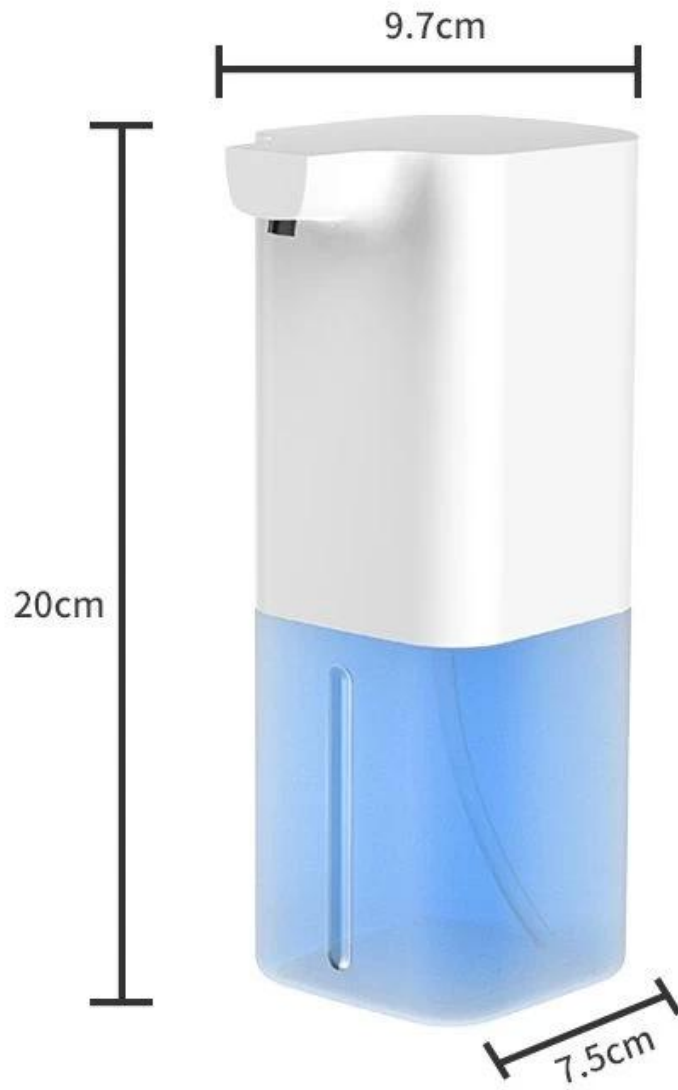

Marine incense

=



Effervescent tablets



MOIST CARE

# NORDIC SIMPLE DESIGN

Marine incense/Osmanthus/Rose fragrance/Lemon scent

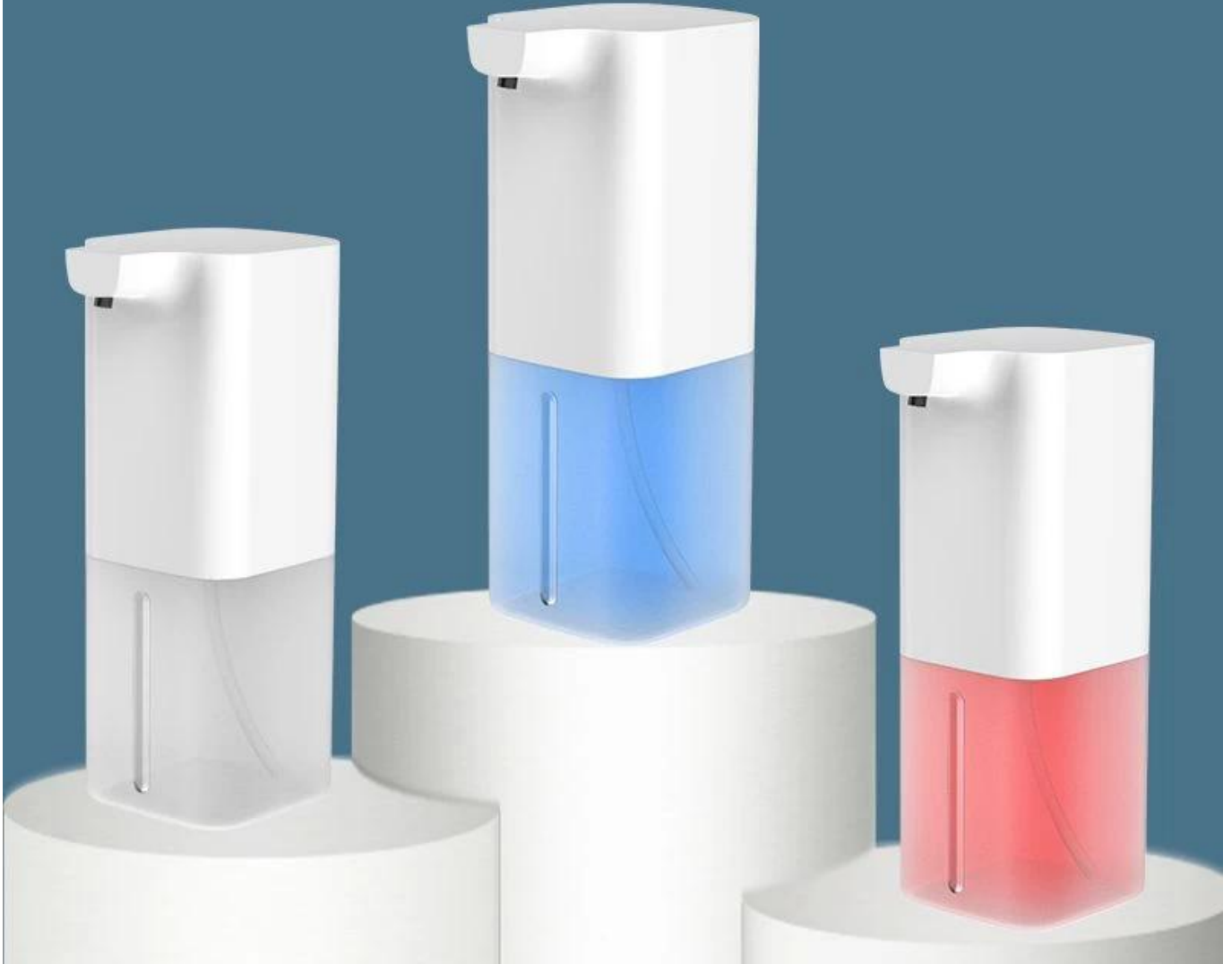

--	--	--	--	--	--	--	--	--	--

本公司所有產品均採用優質材料，品質保證，價格公道。歡迎各界人士垂詢。：0755-26000000  
 本公司產品均採用優質材料，品質保證，價格公道。歡迎各界人士垂詢。：0755-26000000

本公司所有產品均採用優質材料，品質保證，價格公道。歡迎各界人士垂詢。：0755-26000000  
 本公司產品均採用優質材料，品質保證，價格公道。歡迎各界人士垂詢。：0755-26000000

本公司所有產品均採用優質材料，品質保證，價格公道。歡迎各界人士垂詢。：0755-26000000  
 本公司產品均採用優質材料，品質保證，價格公道。歡迎各界人士垂詢。：0755-26000000

በግልጽ ለመረጃ ይጎብኙ።

የሰነድ ማረጋገጫ ለምሳሌ ለግልጽ ገንዘብ ፡፡

የሰነድ ማረጋገጫ ለምሳሌ 2 ዓመት ለግልጽ ሰነድ ማረጋገጫ ፡፡ የሰነድ ማረጋገጫ ለምሳሌ ለግልጽ ሰነድ ማረጋገጫ ለምሳሌ ለግልጽ ሰነድ ማረጋገጫ ፡፡  
በግልጽ OEM / OEM ሰነድ ማረጋገጫ ለምሳሌ ለግልጽ ሰነድ ማረጋገጫ ፡፡